



Vernissage Fachbuch Photovoltaikanlagen | Solothurn, 25. November 2021 | Christof Bucher

ISBN: 978-3-905711-62-2

faktor
Architektur Technik Energie

Christof Bucher

Photovoltaikanlagen

Planung | Installation | Betrieb

Christof Bucher ■ Photovoltaikanlagen ■ Planung – Installation – Betrieb

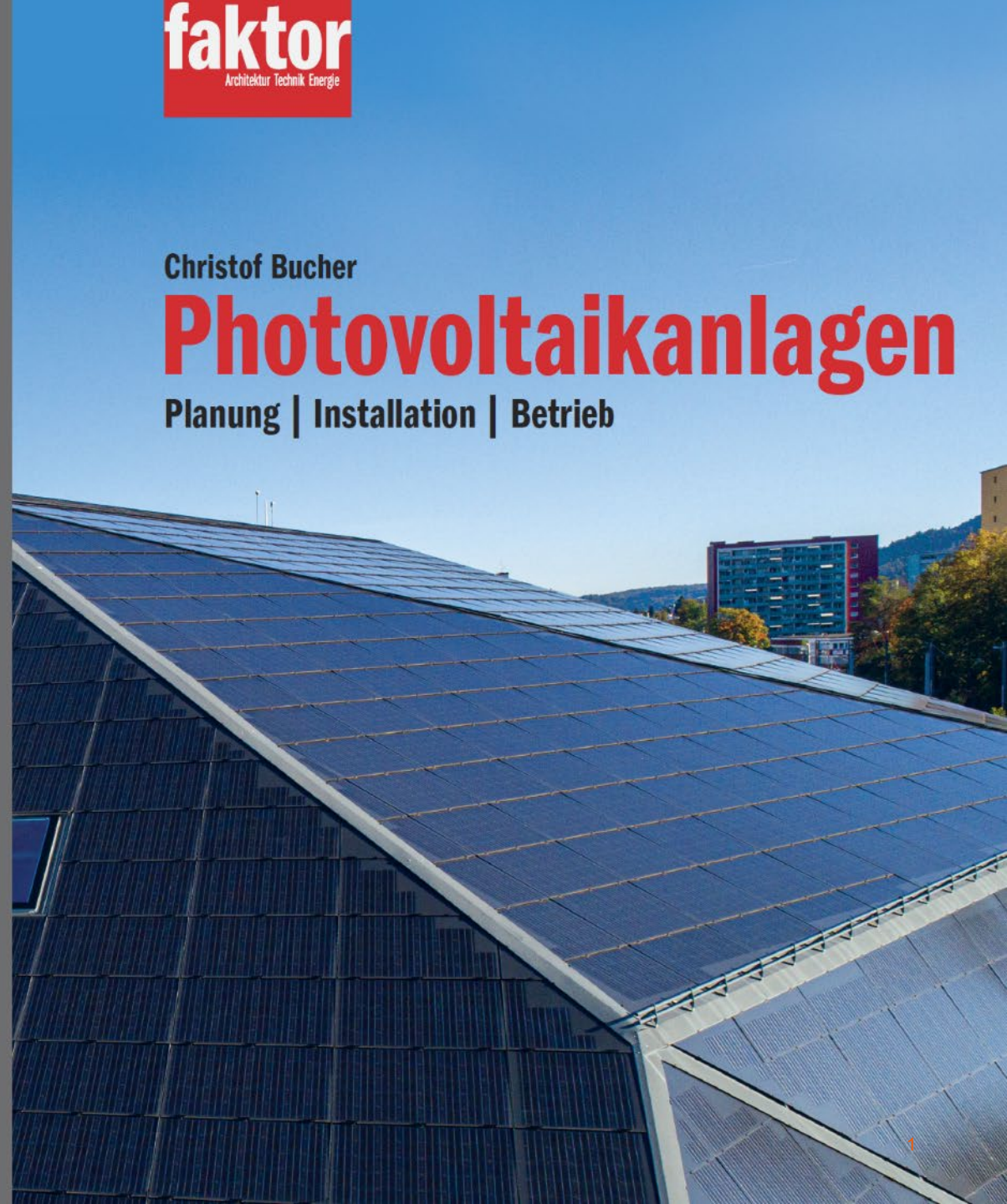

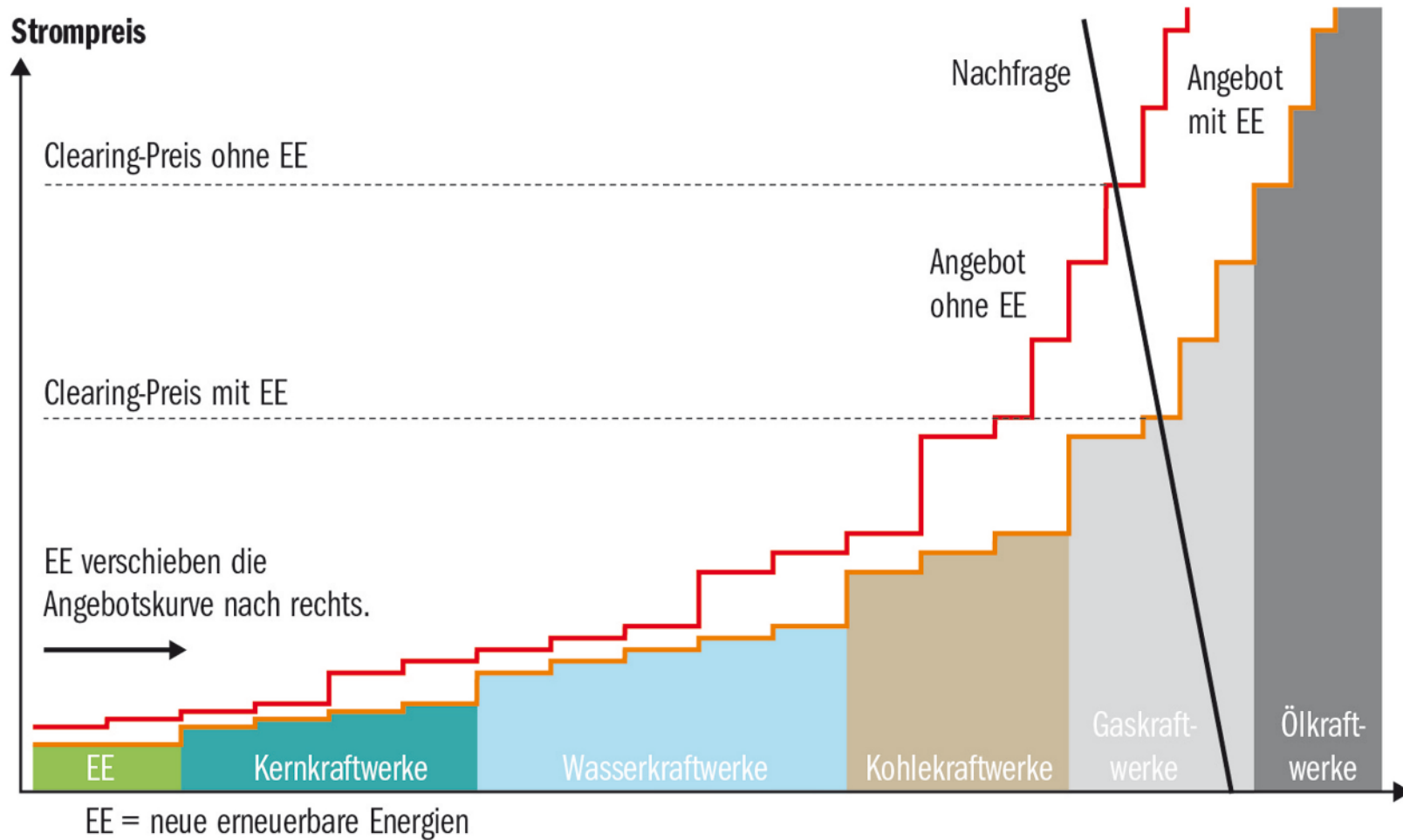

Quelle: Christof Bucher, Photovoltaikanlagen, Faktor Verlag 2021

Investitionskosten: 1000 Fr./kW, LCOE = 8,1 Rp./kWh

		Strompreis (Rp./kWh)										
		16	17	18	19	20	21	22	23	24	25	26
Einspeisetarif (Rp./kWh)	12	0	0	0	0	0	0	0	0	0	0	0
	11	0	0	0	0	0	0	0	0	0	0	0
	10	0	0	0	0	0	0	0	0	0	0	0
	9	0	0	0	0	0	0	0	0	0	0	0
	8	2	1	1	1	1	1	1	1	1	1	1
	7	12	11	10	9	9	8	7	7	7	6	6
	6	21	19	18	16	15	14	13	12	12	11	11
	5	28	26	24	22	21	20	18	17	16	16	15
	4	34	32	29	27	26	24	23	22	21	20	19

Investitionskosten: 2000 Fr./kW, LCOE = 13,2 Rp./kWh

		Strompreis (Rp./kWh)										
		16	17	18	19	20	21	22	23	24	25	26
Einspeisetarif (Rp./kWh)	12	31	25	21	18	16	14	12	11	10	10	9
	11	45	37	32	28	25	22	20	19	17	16	15
	10	54	46	41	36	32	29	27	25	23	22	20
	9	61	53	47	42	39	35	33	30	28	27	25
	8	66	58	52	48	44	40	37	35	33	31	29
	7	69	62	57	52	48	45	42	39	37	35	33
	6	72	66	60	56	52	48	45	43	40	38	36
	5	75	69	63	59	55	52	48	46	43	41	39
	4	77	71	66	62	58	54	51	49	46	44	42

Quelle: Christof Bucher, Photovoltaikanlagen, Faktor Verlag 2021

Jahresenergieproduktion in TWh

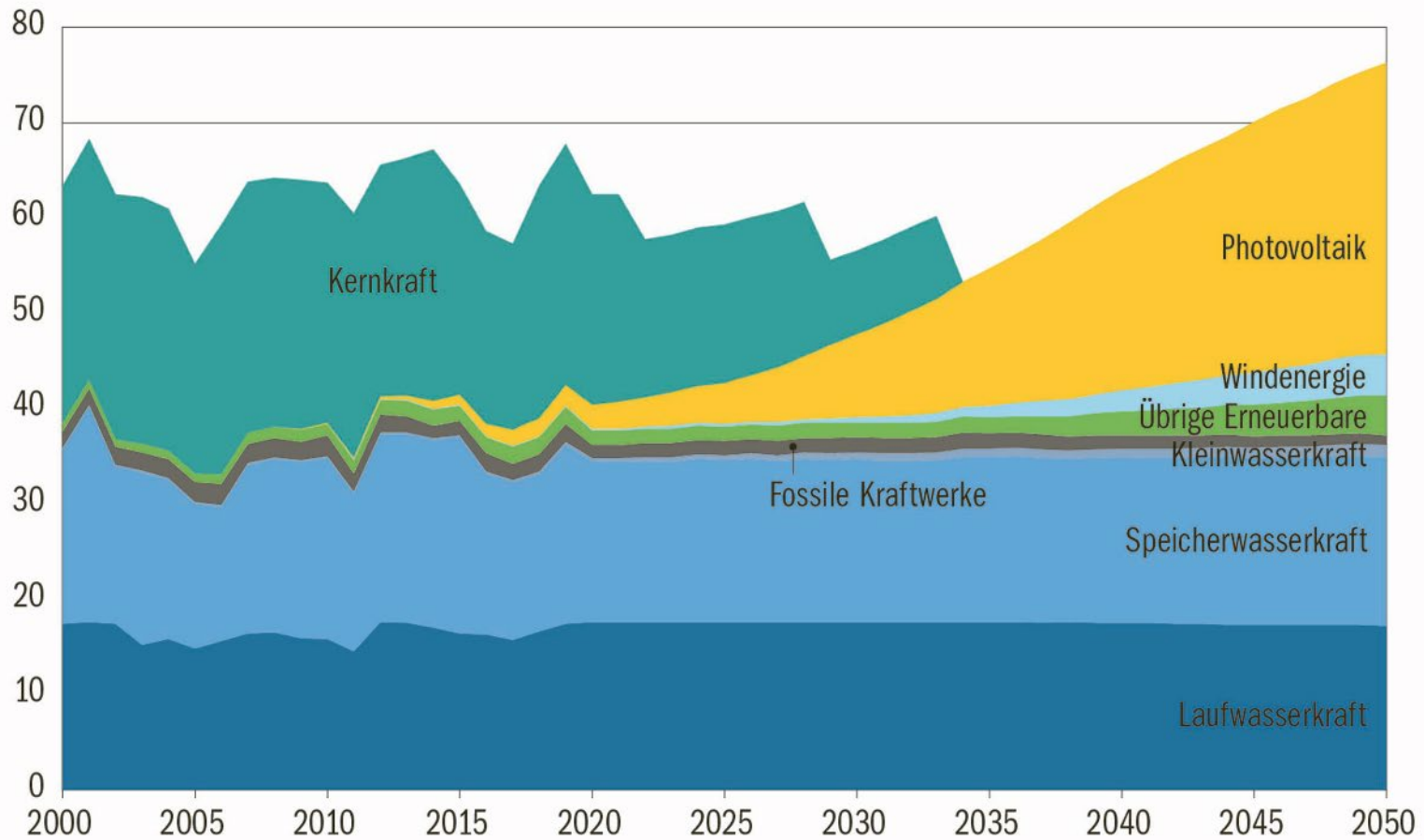

Quelle: Christof Bucher, Photovoltaikanlagen, Faktor Verlag 2021

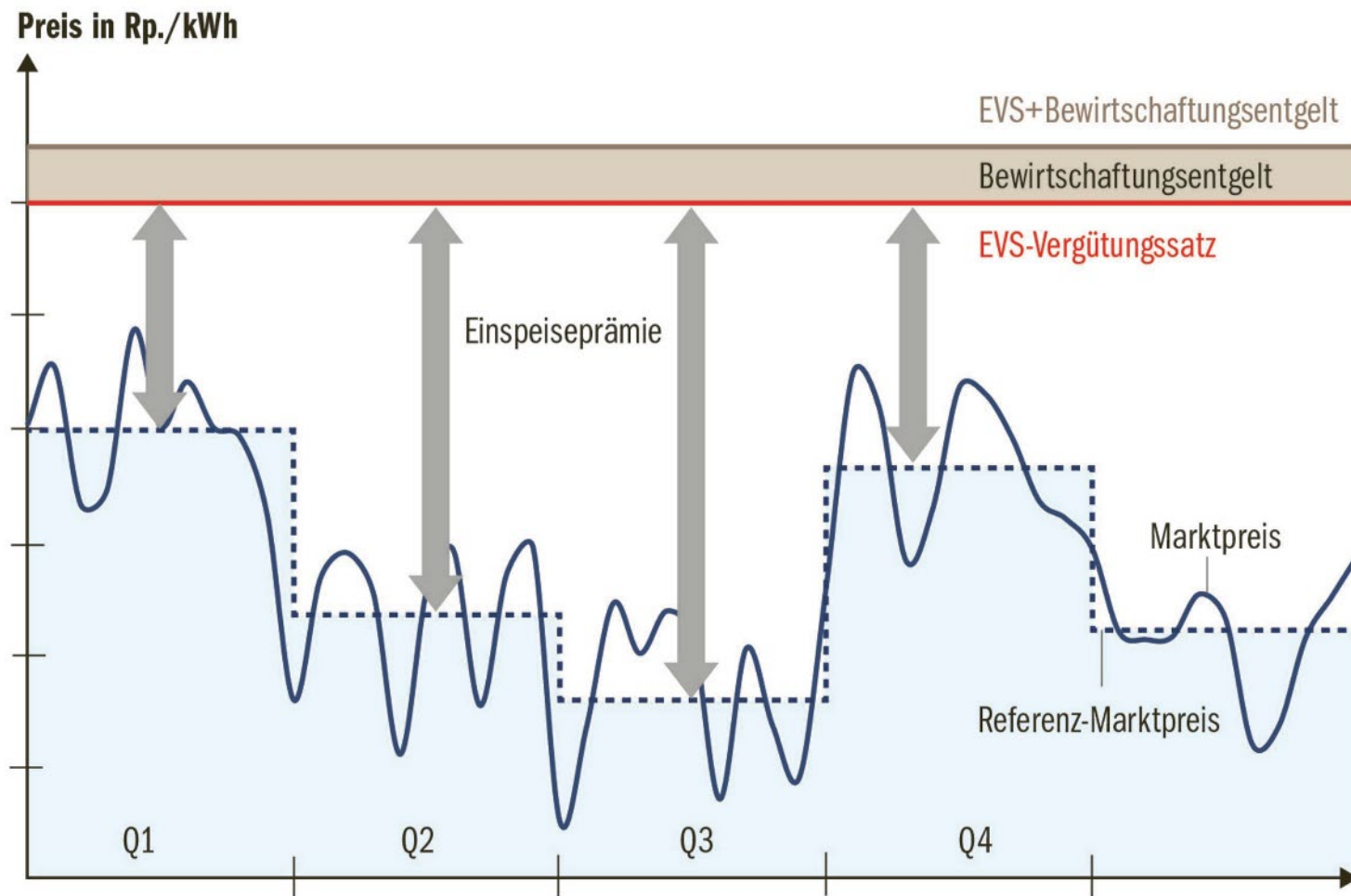

Quelle: Christof Bucher, Photovoltaikanlagen, Faktor Verlag 2021

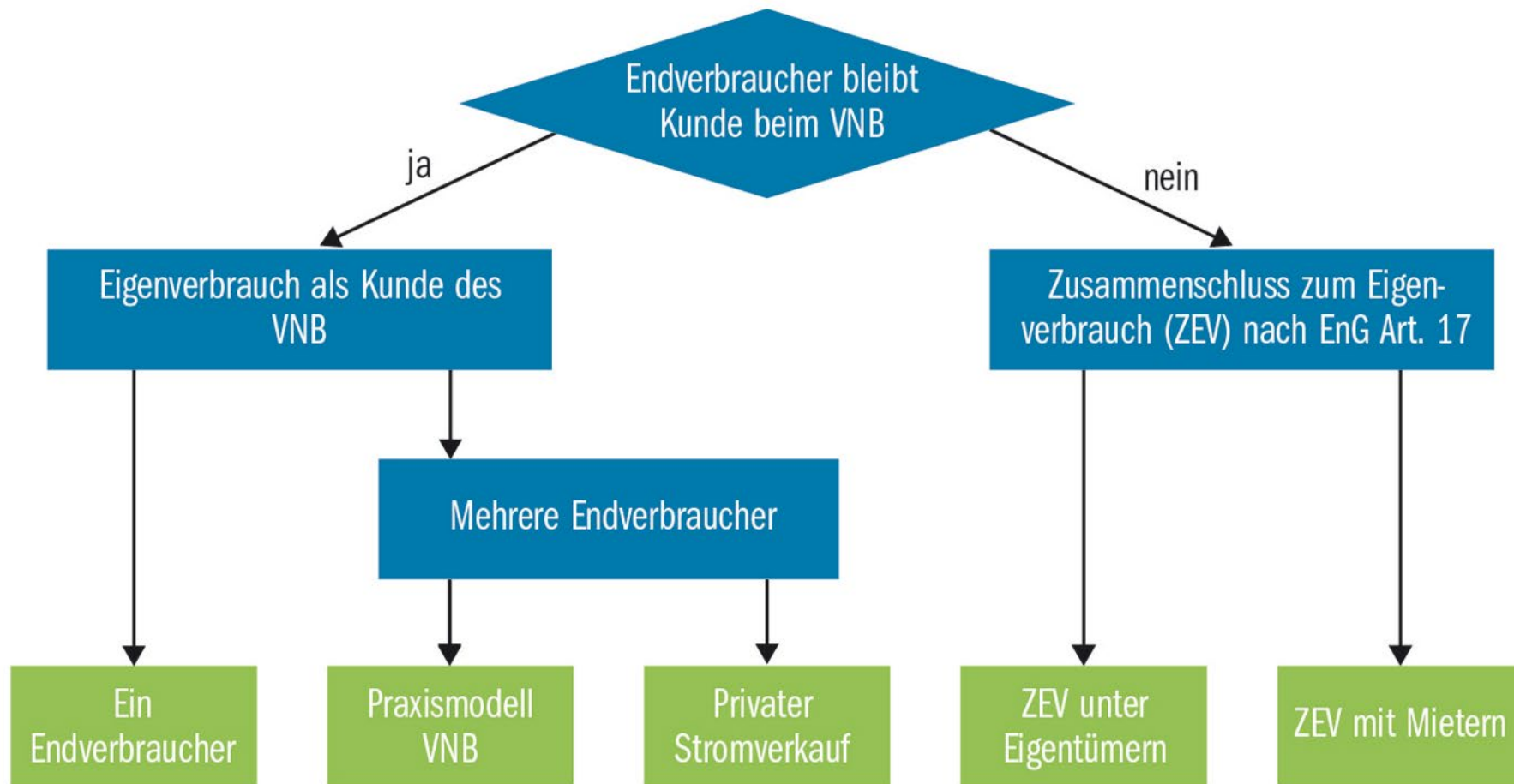

Quelle: Christof Bucher, Photovoltaikanlagen, Faktor Verlag 2021



Quelle: Christof Bucher, Photovoltaikanlagen, Faktor Verlag 2021

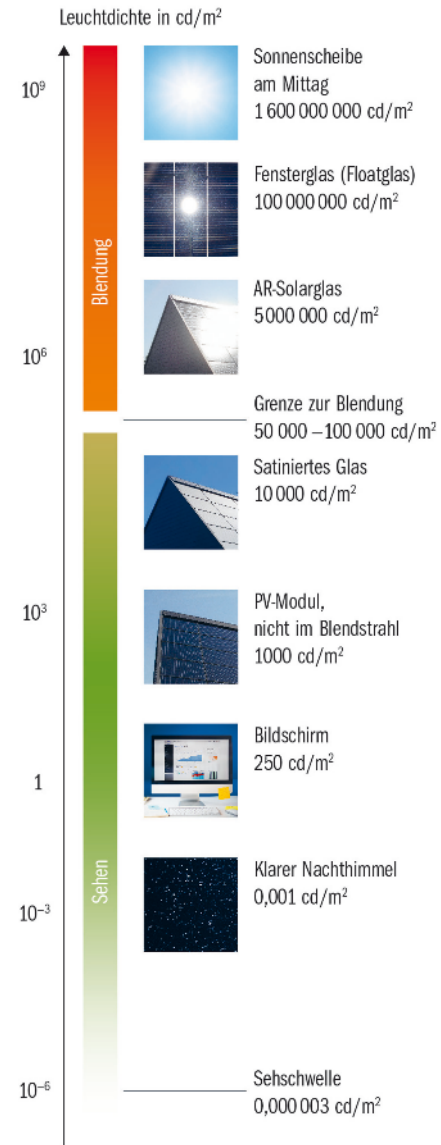

Elevationswinkel der Reflexion (°)

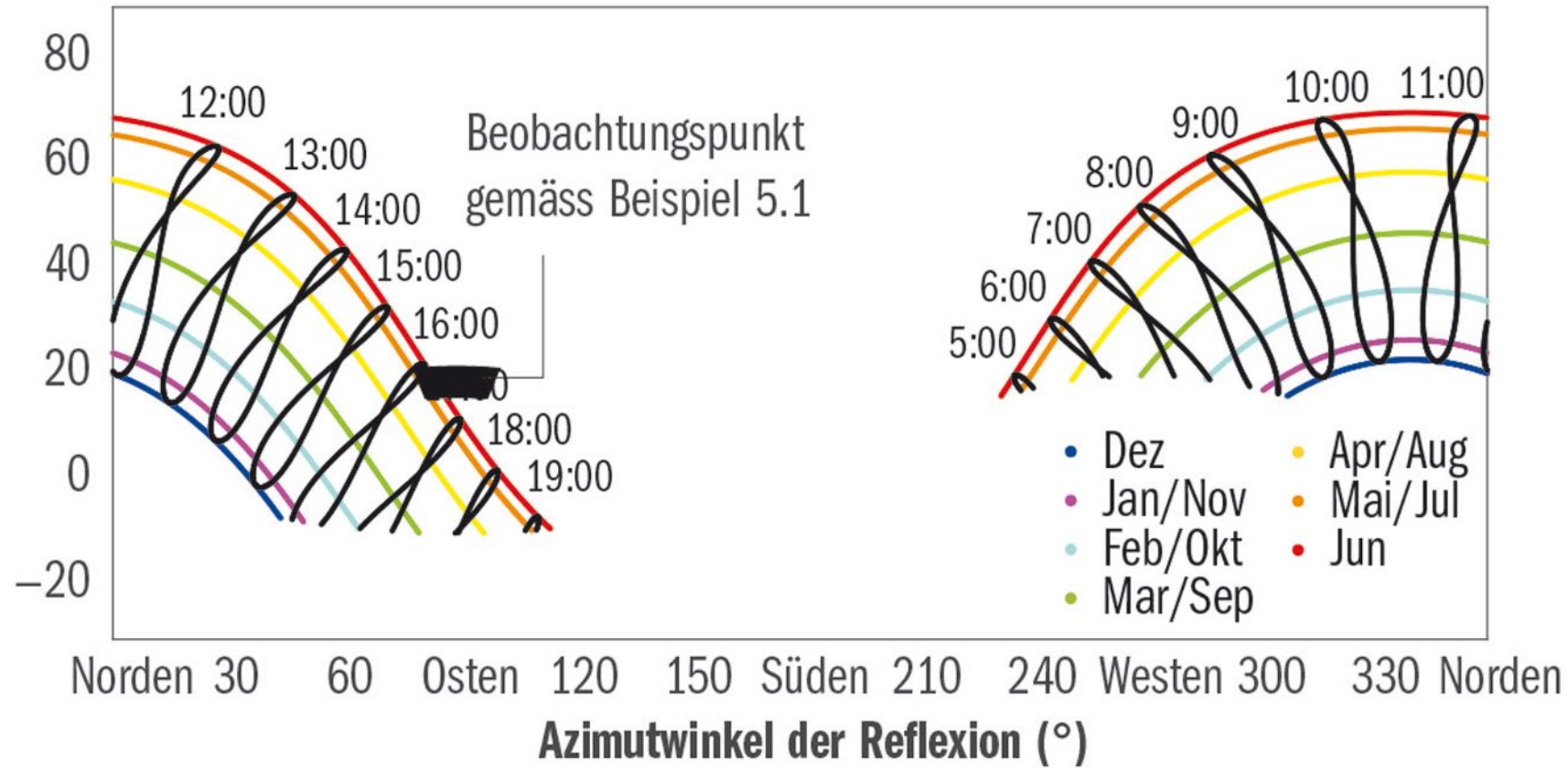

Quelle: Christof Bucher, Photovoltaikanlagen, Faktor Verlag 2021

Elevationswinkel der Sonne (°)

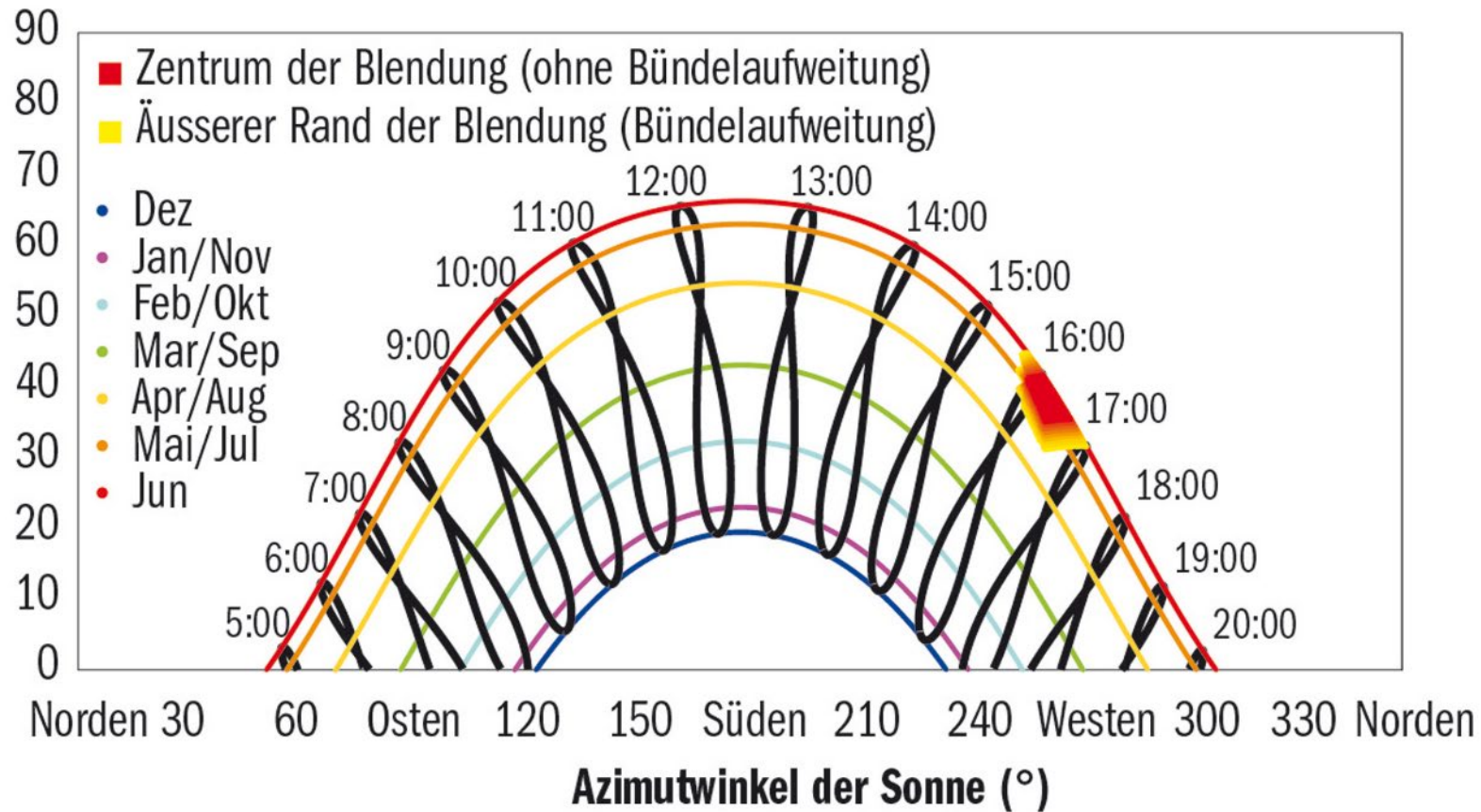

Quelle: Christof Bucher, Photovoltaikanlagen, Faktor Verlag 2021

Tageszeit (Stunde)

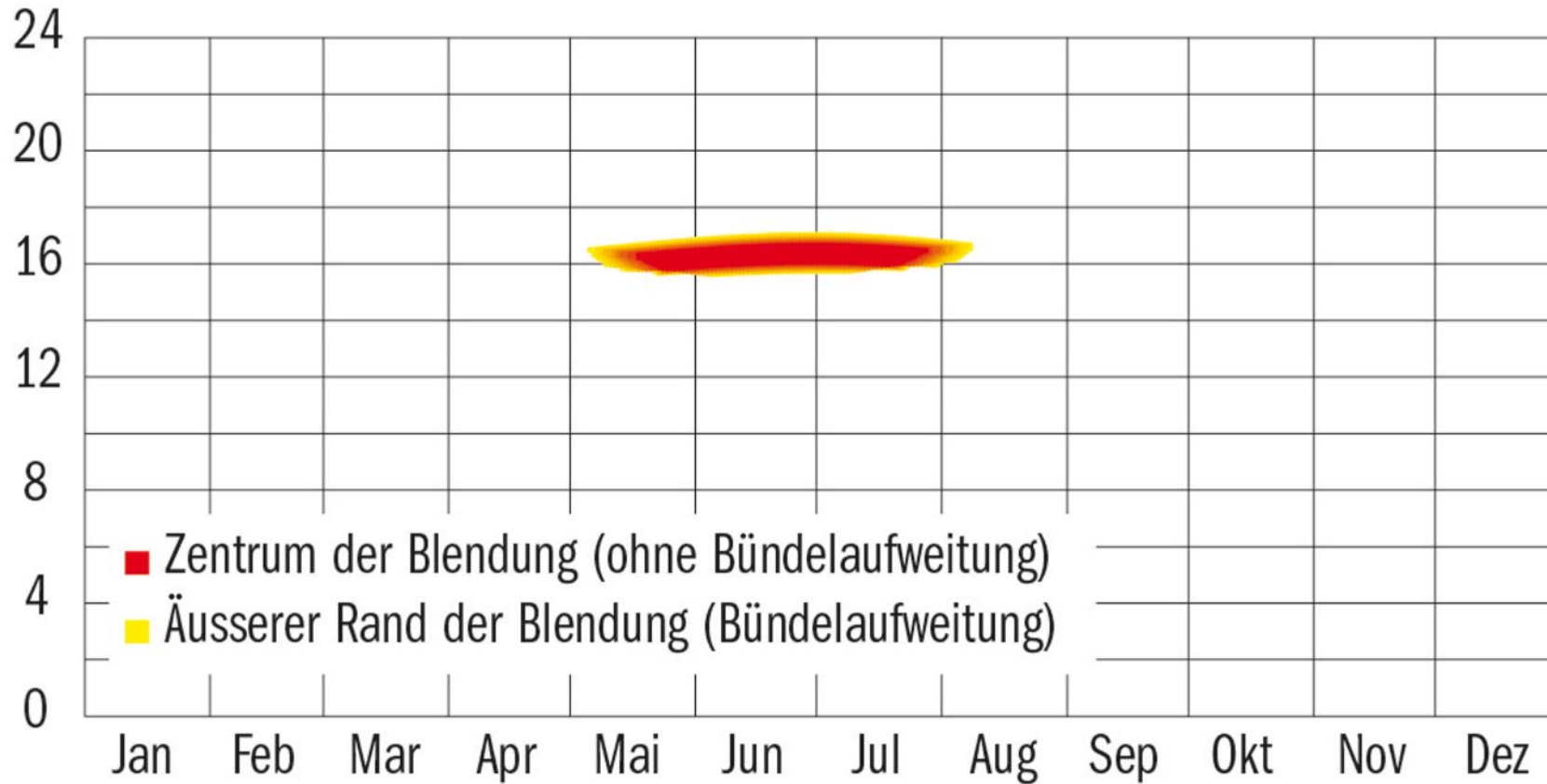

Quelle: Christof Bucher, Photovoltaikanlagen, Faktor Verlag 2021

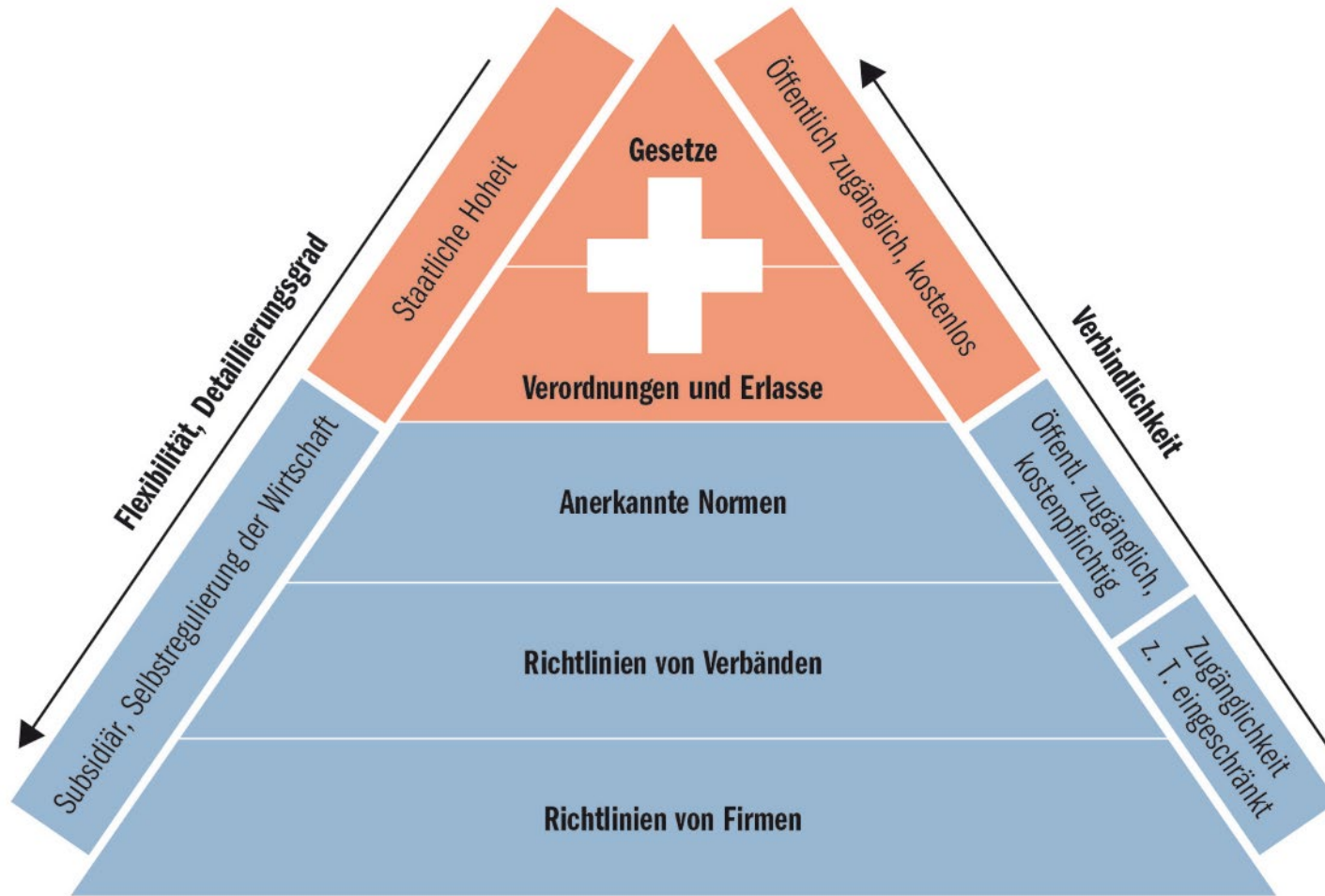

Quelle: Christof Bucher, Photovoltaikanlagen, Faktor Verlag 2021



Quelle: Christof Bucher, Photovoltaikanlagen, Faktor Verlag 2021

Energierückzahldauer in Jahren

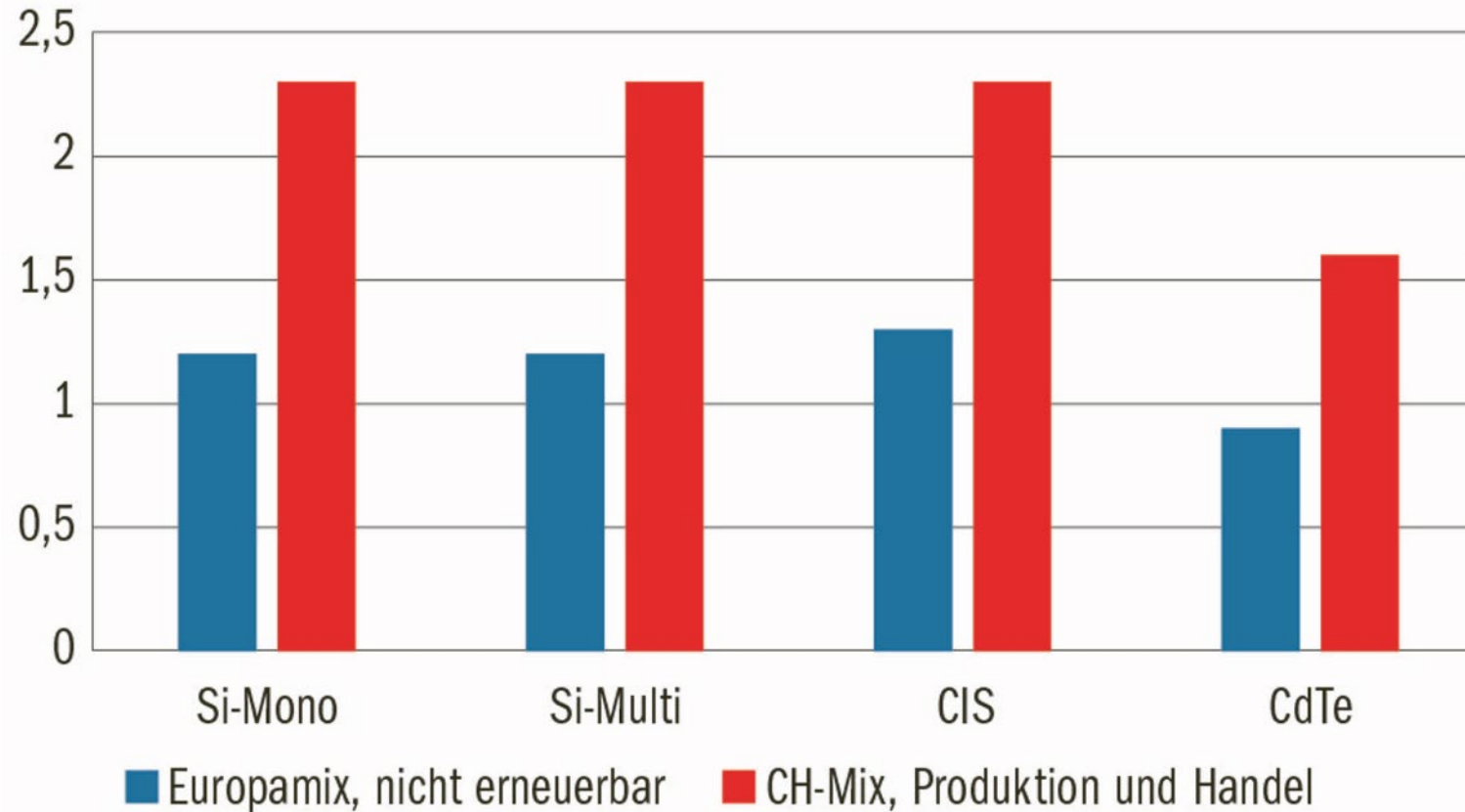

Quelle: Christof Bucher, Photovoltaikanlagen, Faktor Verlag 2021

CO₂-Äquivalenz in g/kWh Strom

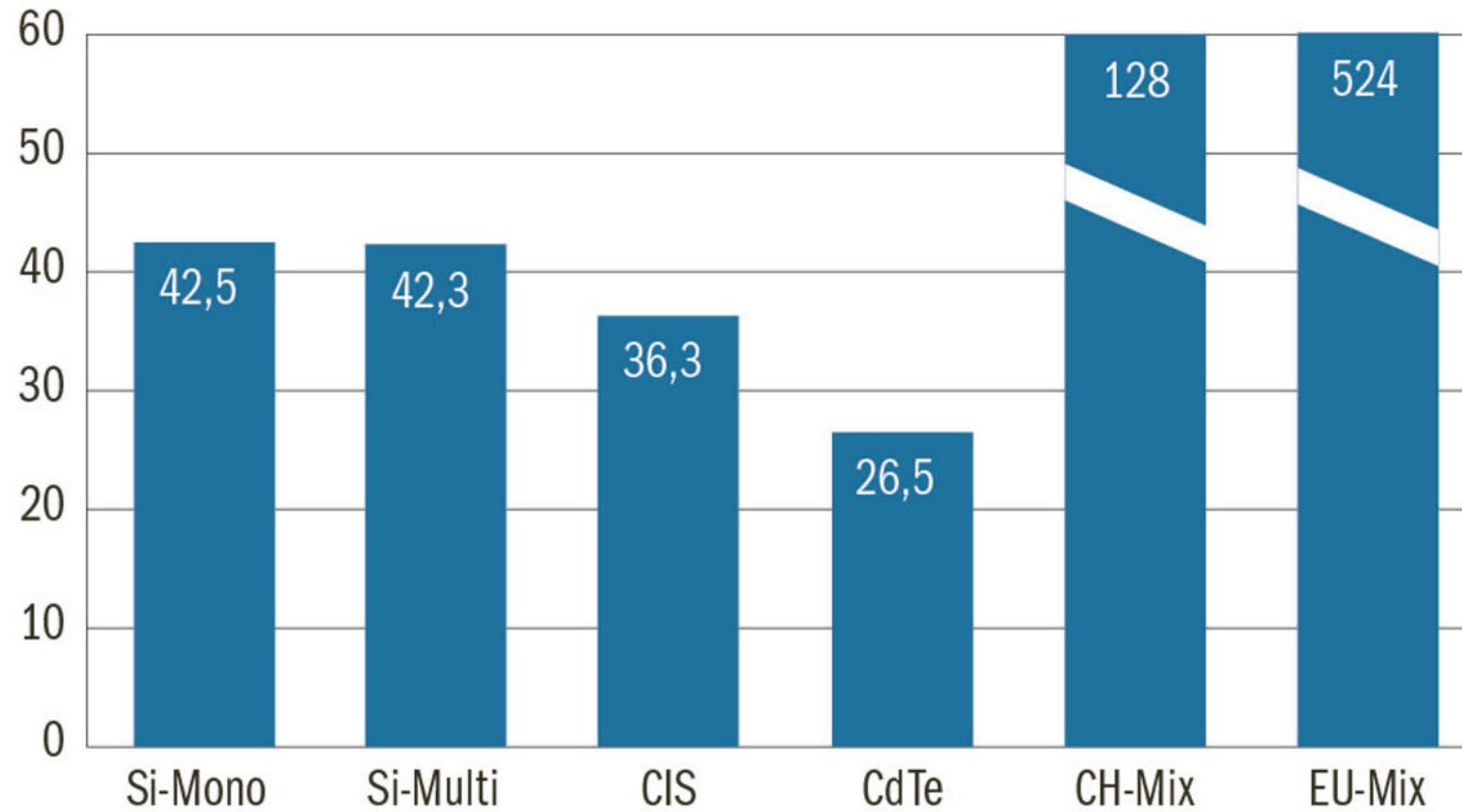

Quelle: Christof Bucher, Photovoltaikanlagen, Faktor Verlag 2021

Umweltbelastungspunkte (UBP'13) pro kWh Strom

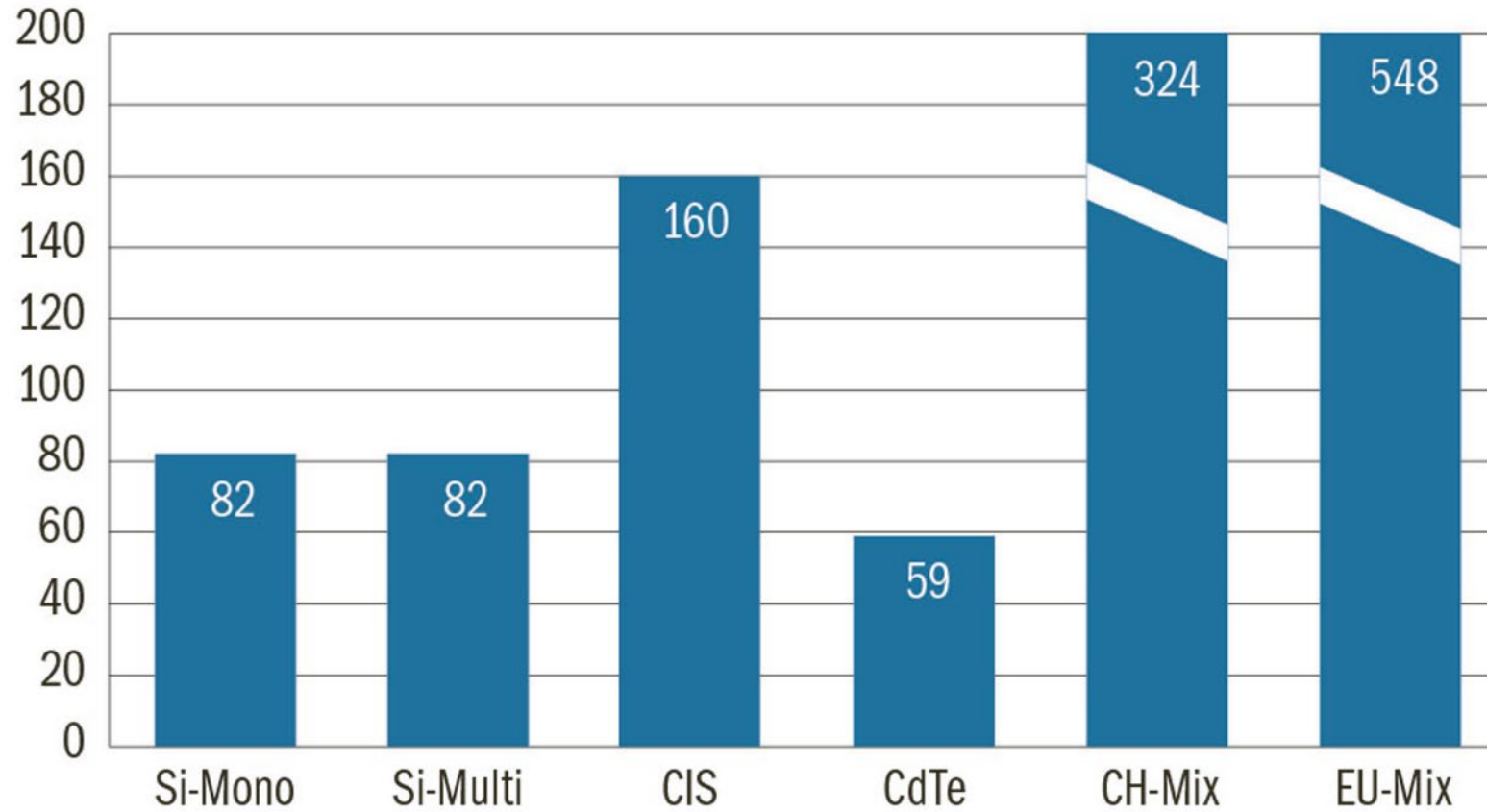

Quelle: Christof Bucher, Photovoltaikanlagen, Faktor Verlag 2021

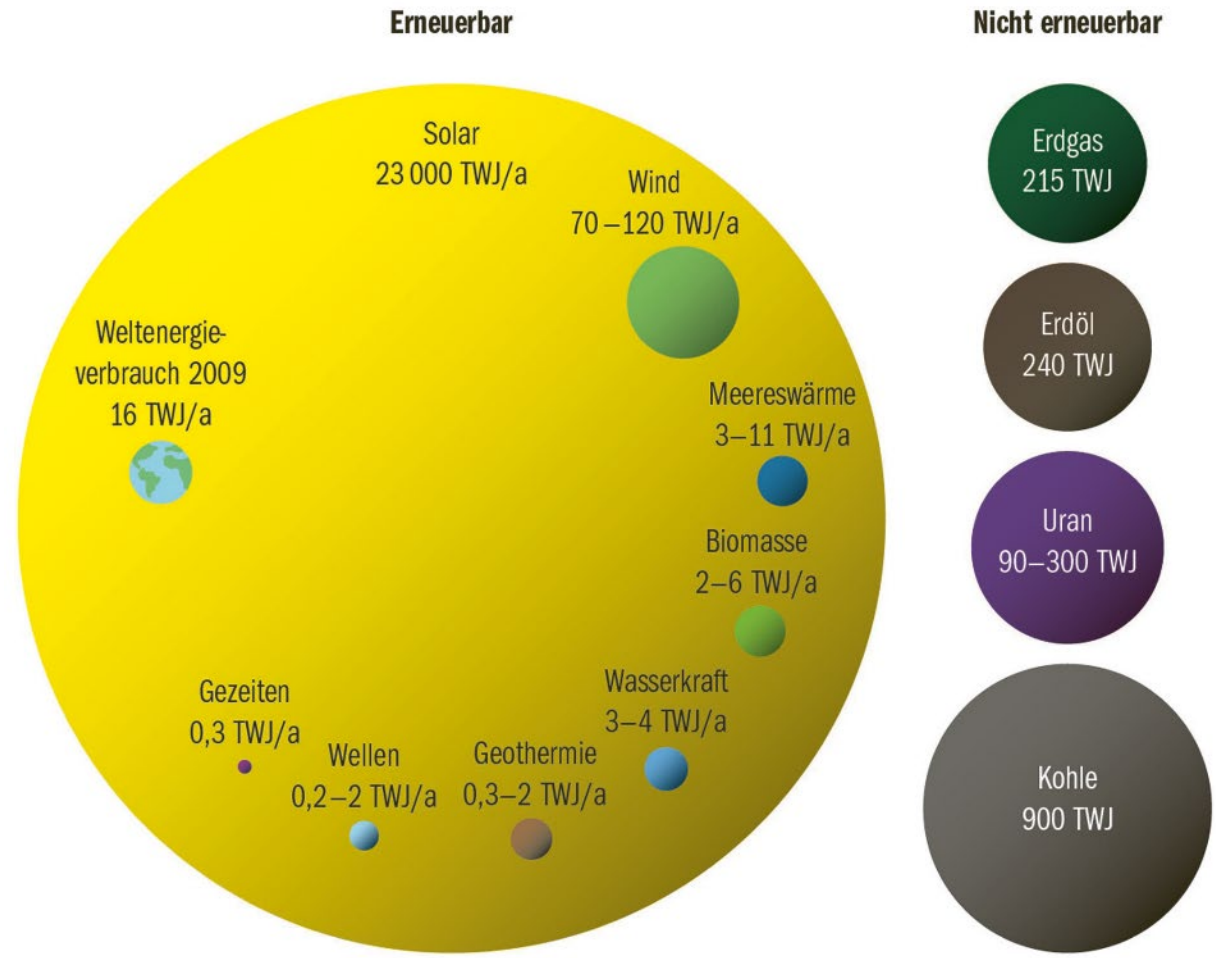

Quelle: Christof Bucher, Photovoltaikanlagen, Faktor Verlag 2021

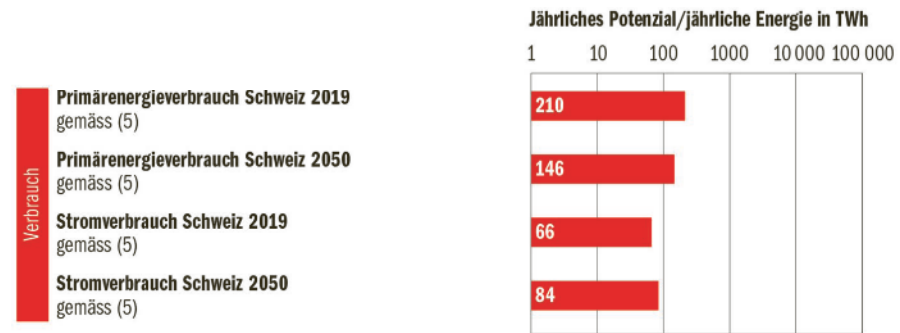
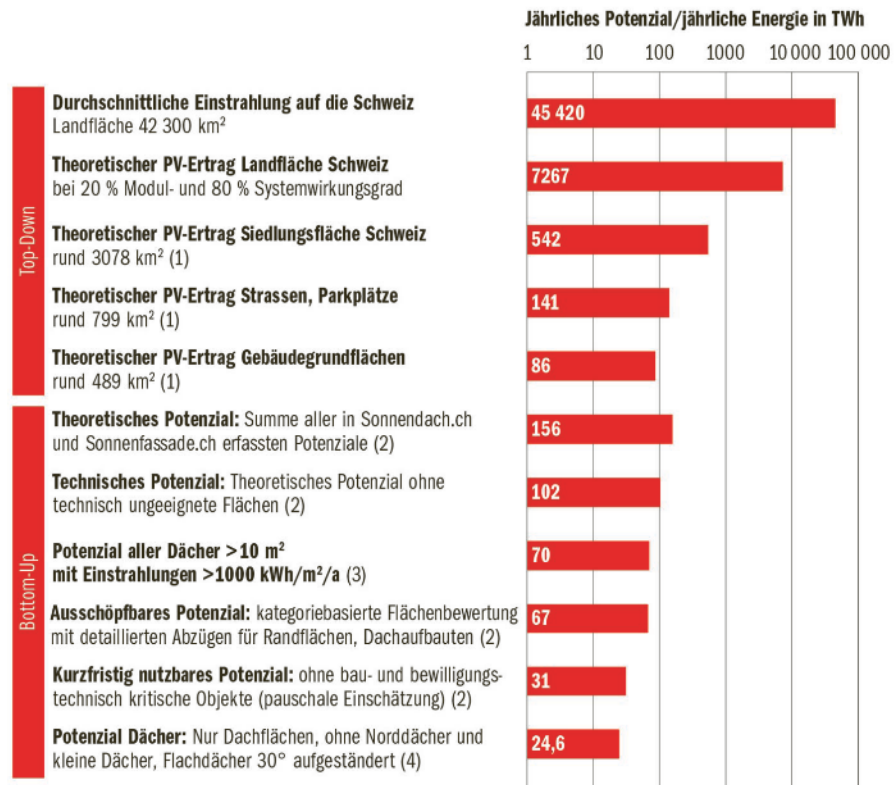

Datenquellen

- 1) Quelle für Flächen: Bundesamt für Statistik BFS, Arealstatistik
- 2) Swissolar, Detailanalyse Solarpotenzial auf Dächern und Fassaden, basierend auf Daten von Sonnendach.ch und Sonnenfassade.ch von Meteotest
- 3) Bauer et al., Potenziale, Kosten und Umweltauswirkungen von Stromproduktionsanlagen, PSI, 2019
- 4) Walch et al., Big data mining for the estimation of hourly rooftop photovoltaic potential and its uncertainty, EPFL, 2020
- 5) Energieperspektiven 2050+, Bundesamt für Energie

Quelle: Christof Bucher, Photovoltaikanlagen, Faktor Verlag 2021

Einstrahlung in $\text{W}/\text{m}^2/\text{nm}$

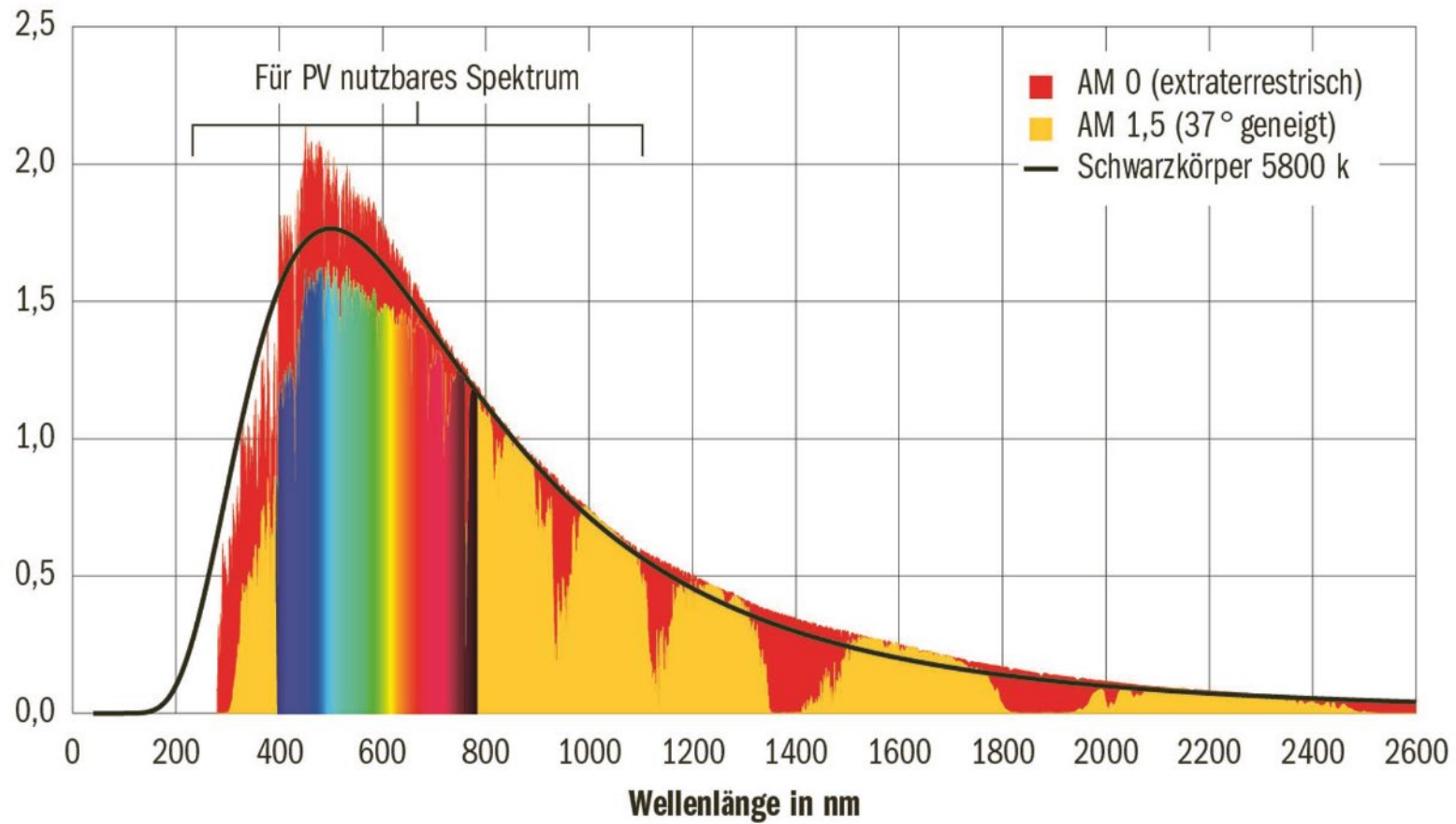

Quelle: Christof Bucher, Photovoltaikanlagen, Faktor Verlag 2021

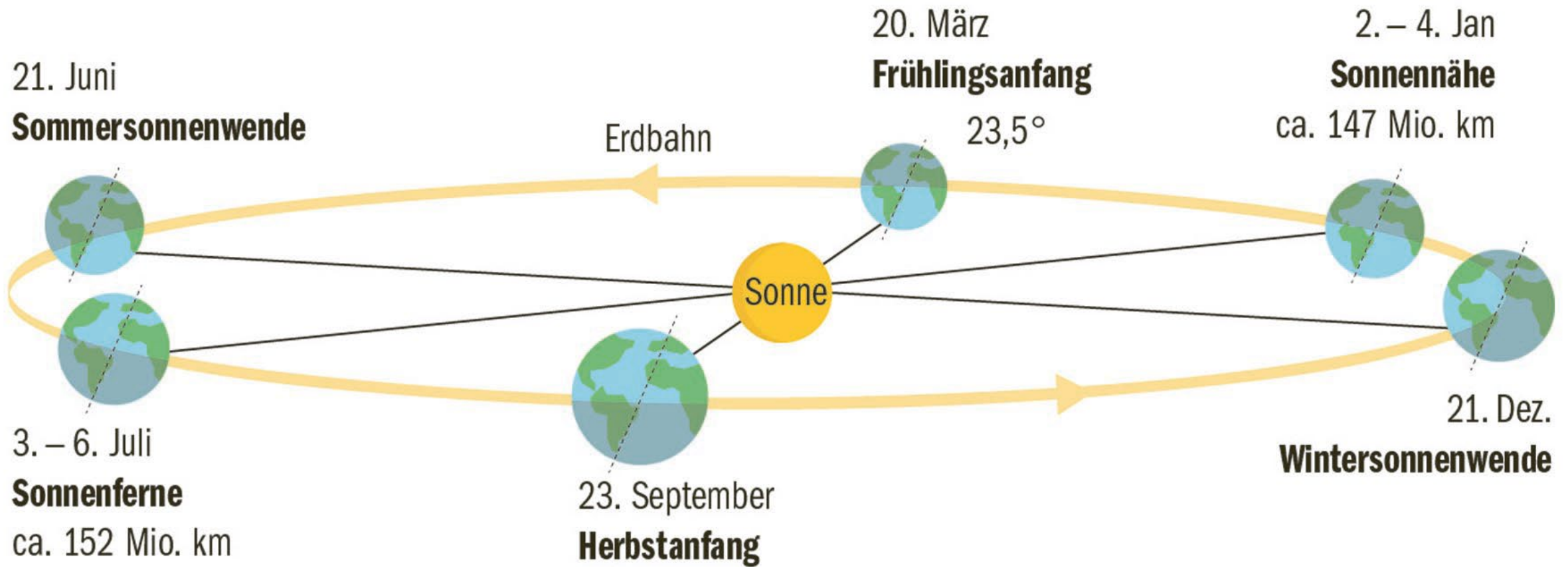

Quelle: Christof Bucher, Photovoltaikanlagen, Faktor Verlag 2021

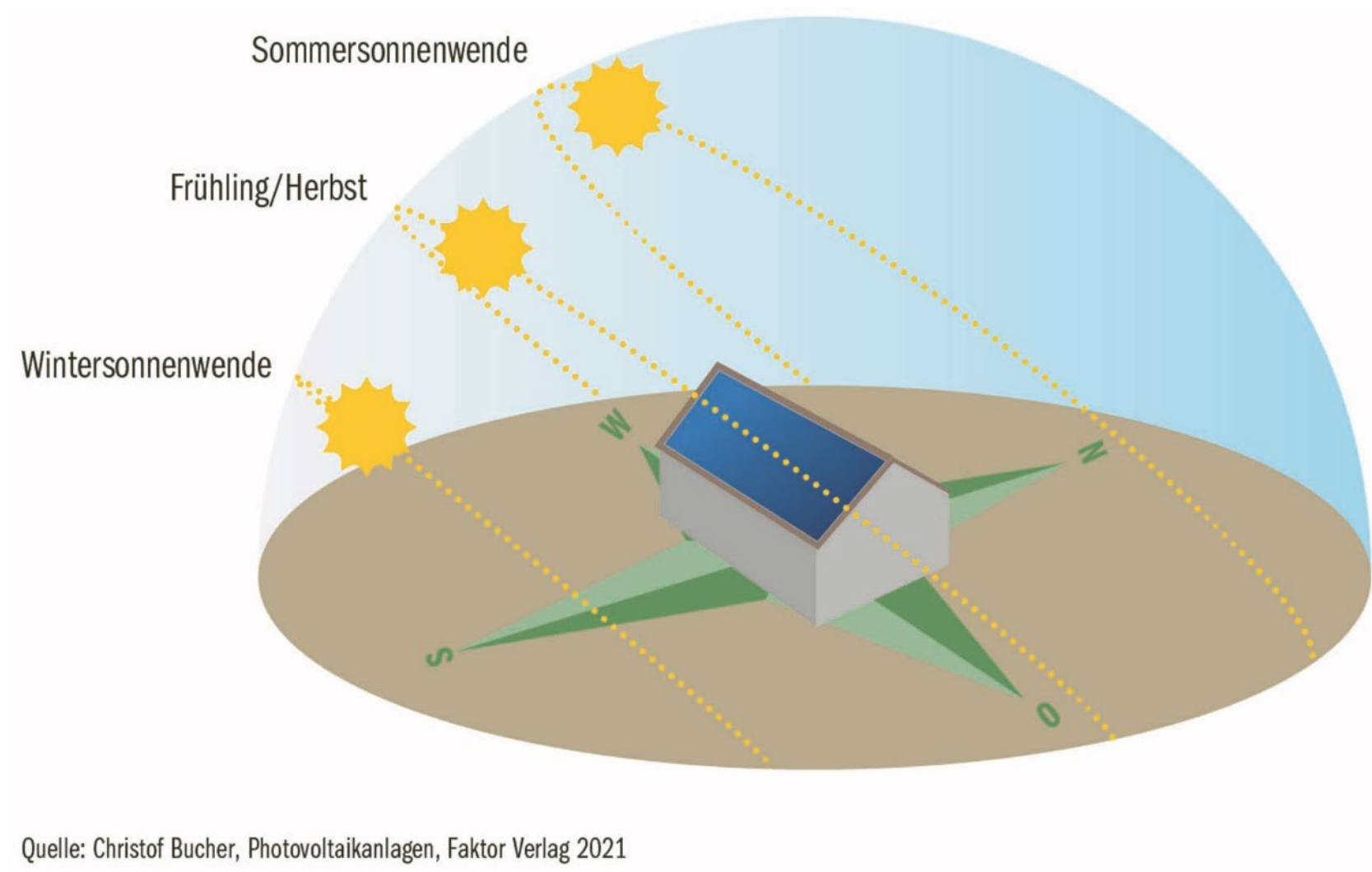

Sonnenstandsdiagramm

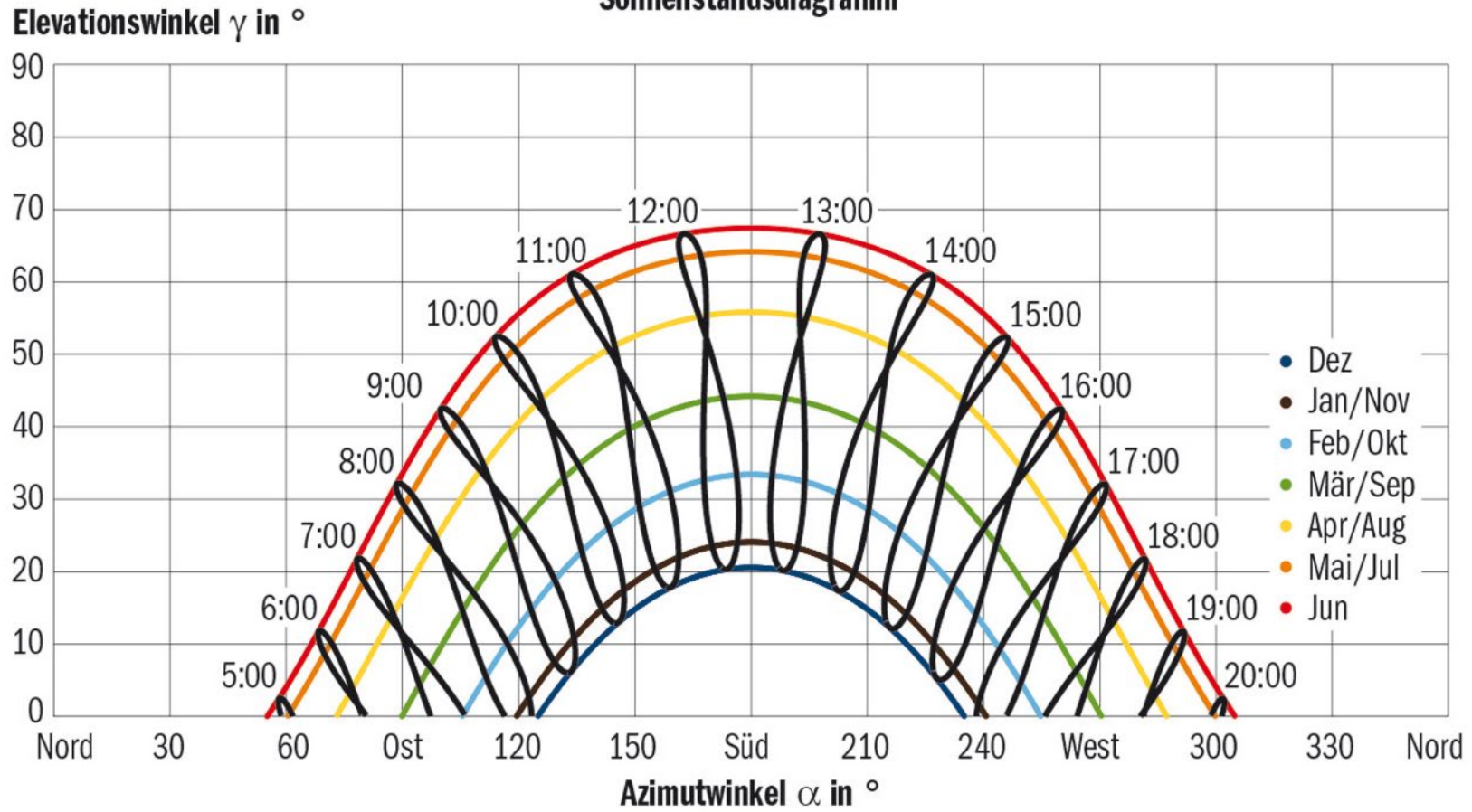

Quelle: Christof Bucher, Photovoltaikanlagen, Faktor Verlag 2021

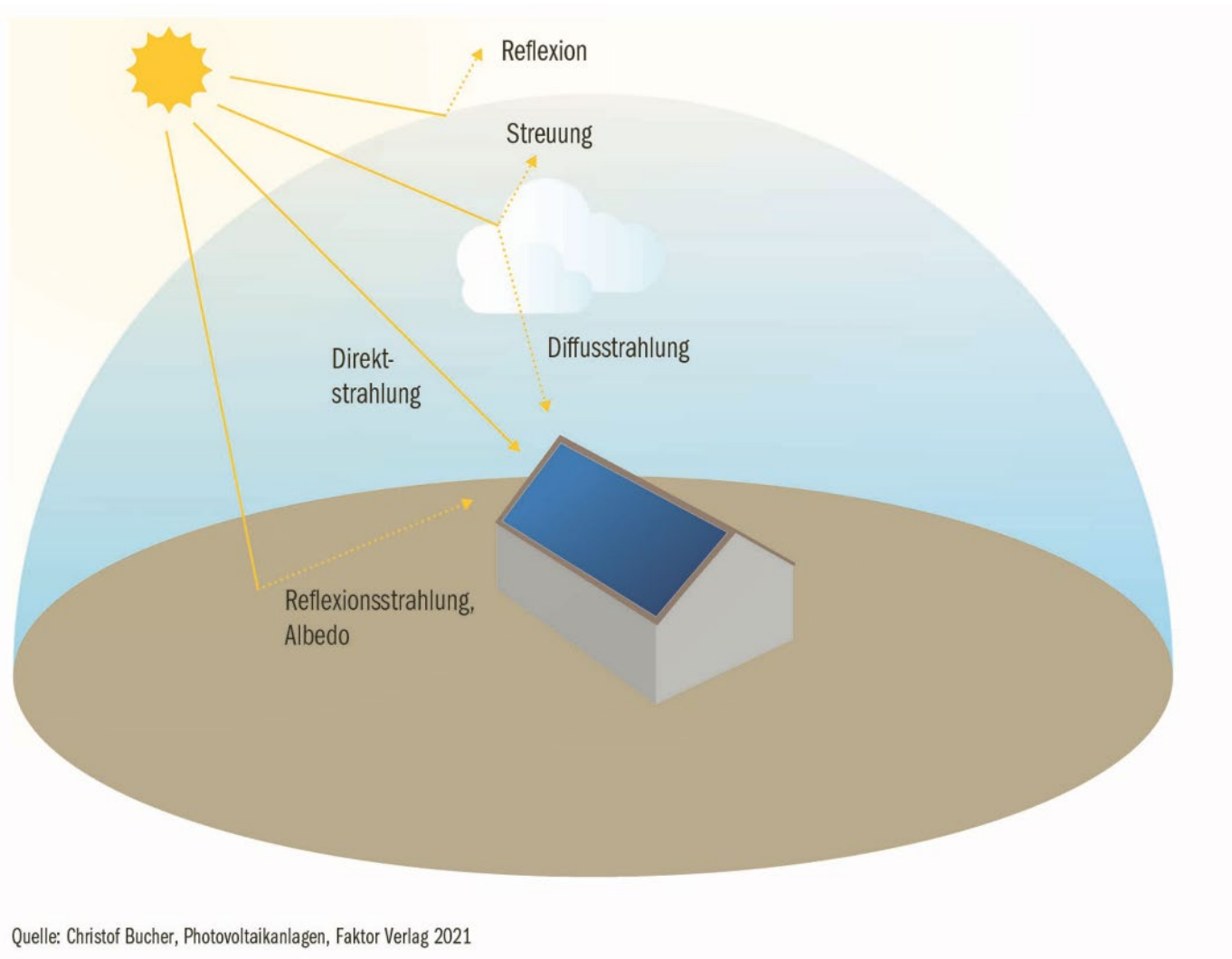

Quelle: Christof Bucher, Photovoltaikanlagen, Faktor Verlag 2021

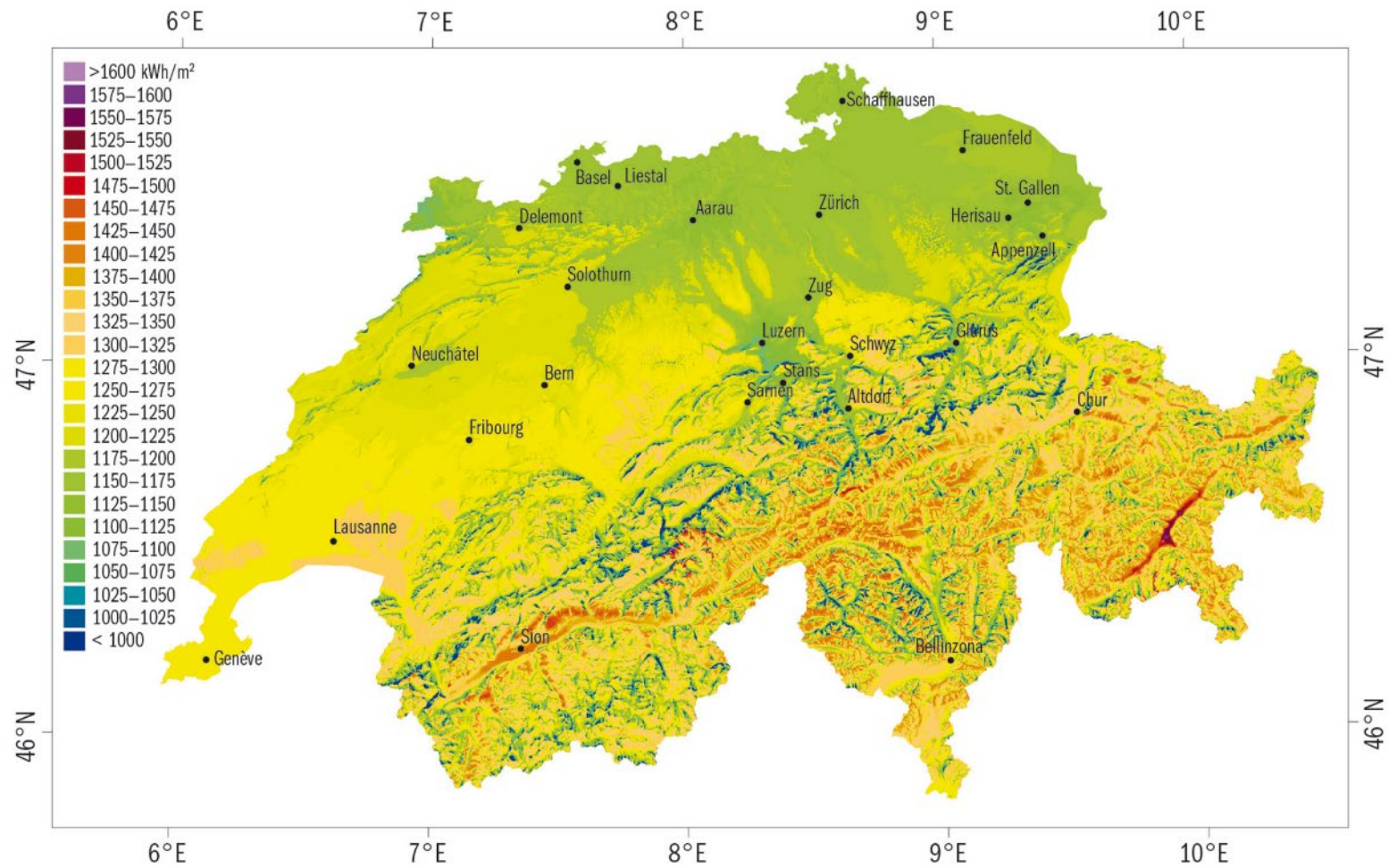

Quelle: Christof Bucher, Photovoltaikanlagen, Faktor Verlag 2021

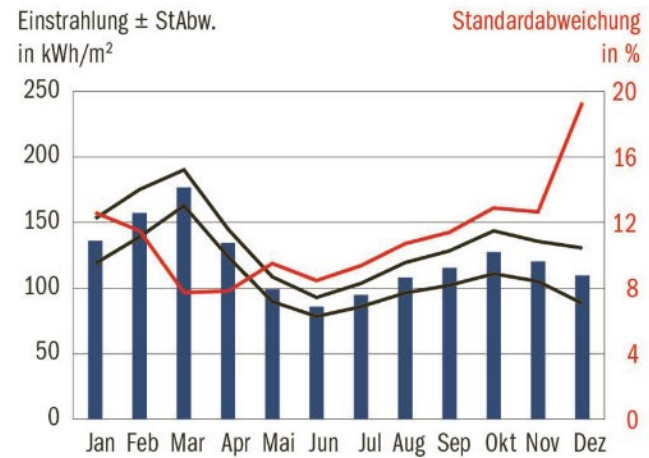
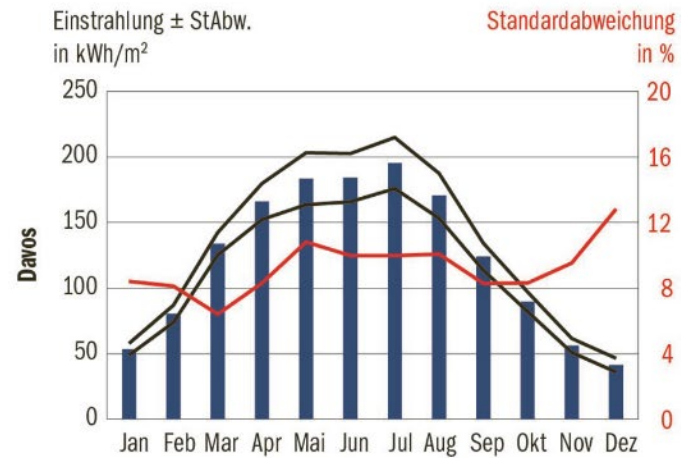
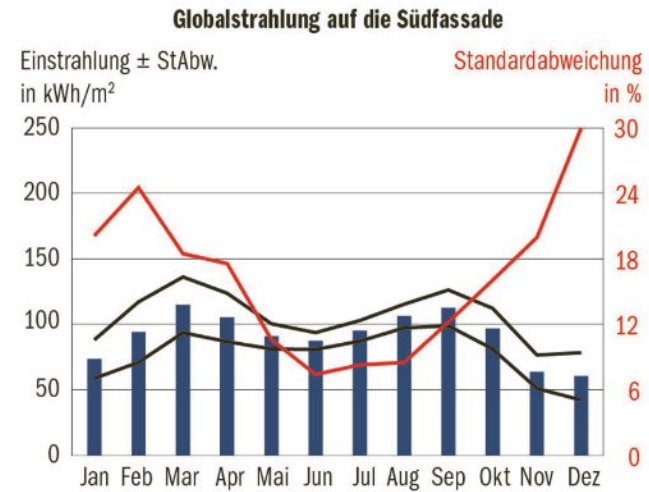

Quelle: Christof Bucher, Photovoltaikanlagen, Faktor Verlag 2021

Einstrahlung in W/m²

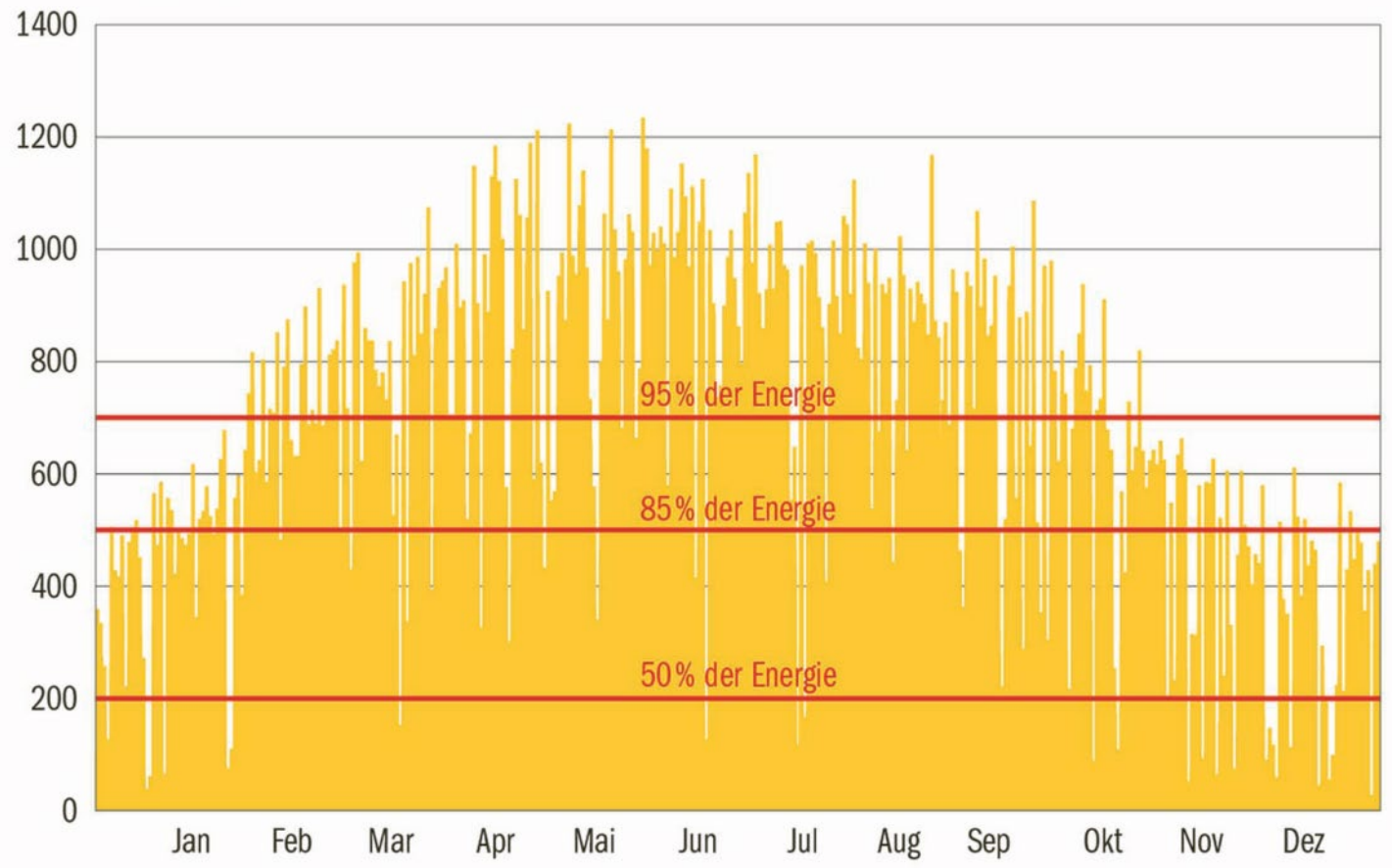

Quelle: Christof Bucher, Photovoltaikanlagen, Faktor Verlag 2021

Anteil an der Jahreseinstrahlung in %

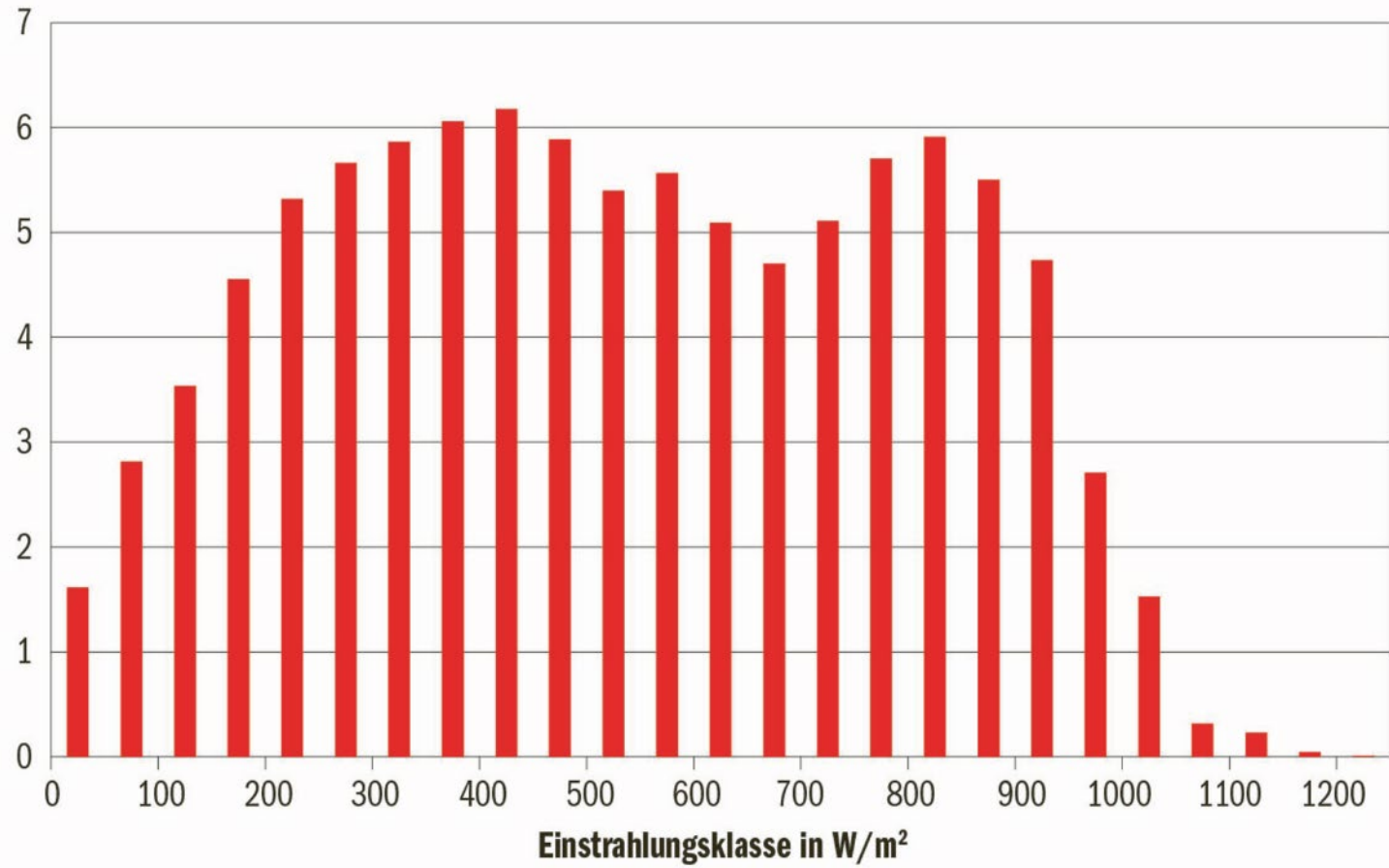

Quelle: Christof Bucher, Photovoltaikanlagen, Faktor Verlag 2021

Globalstrahlung Gh in W/m²

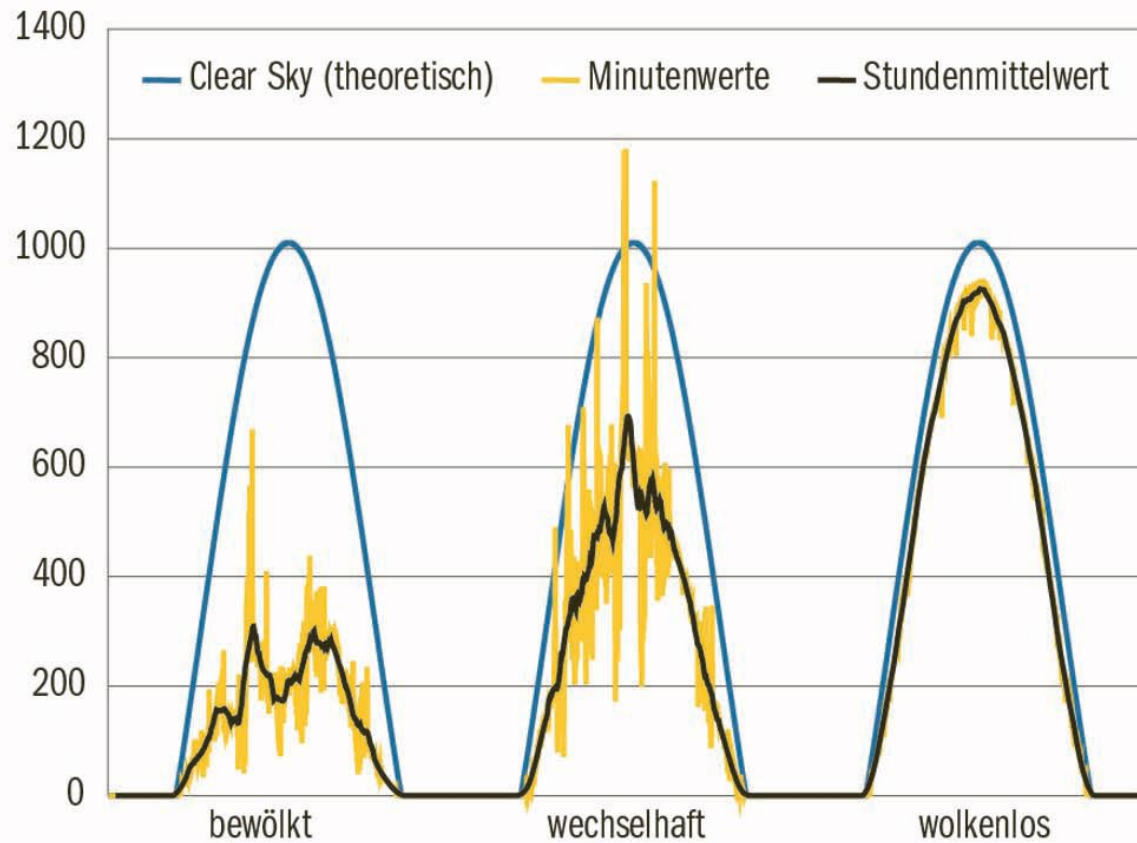

Quelle: Christof Bucher, Photovoltaikanlagen, Faktor Verlag 2021

Zelltemperatur in °C

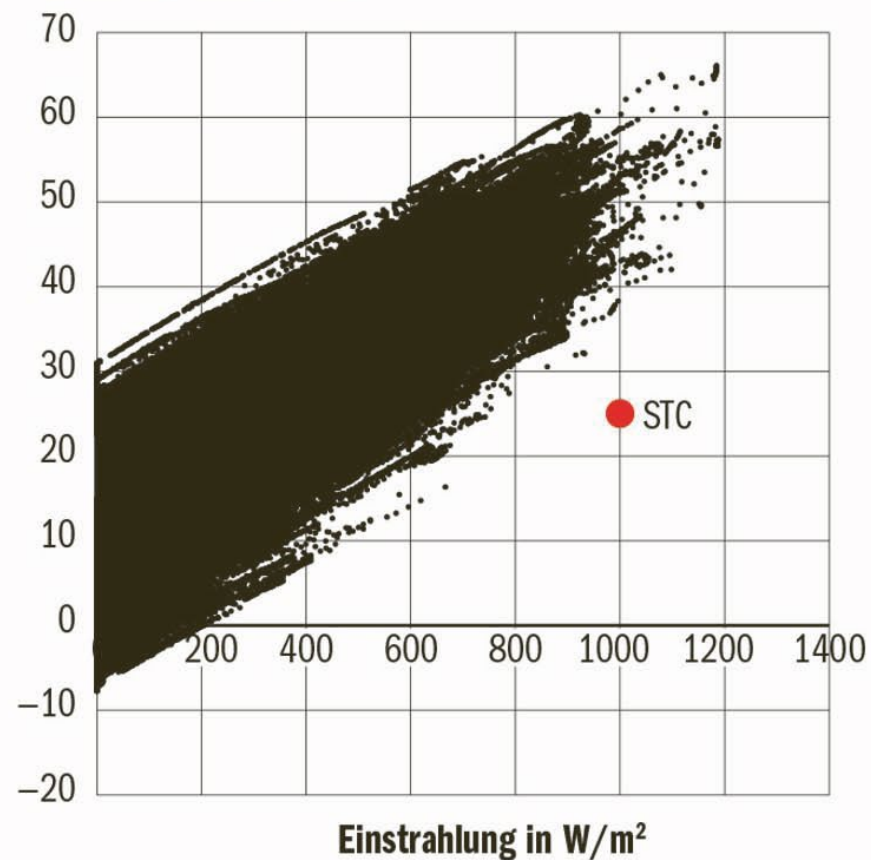

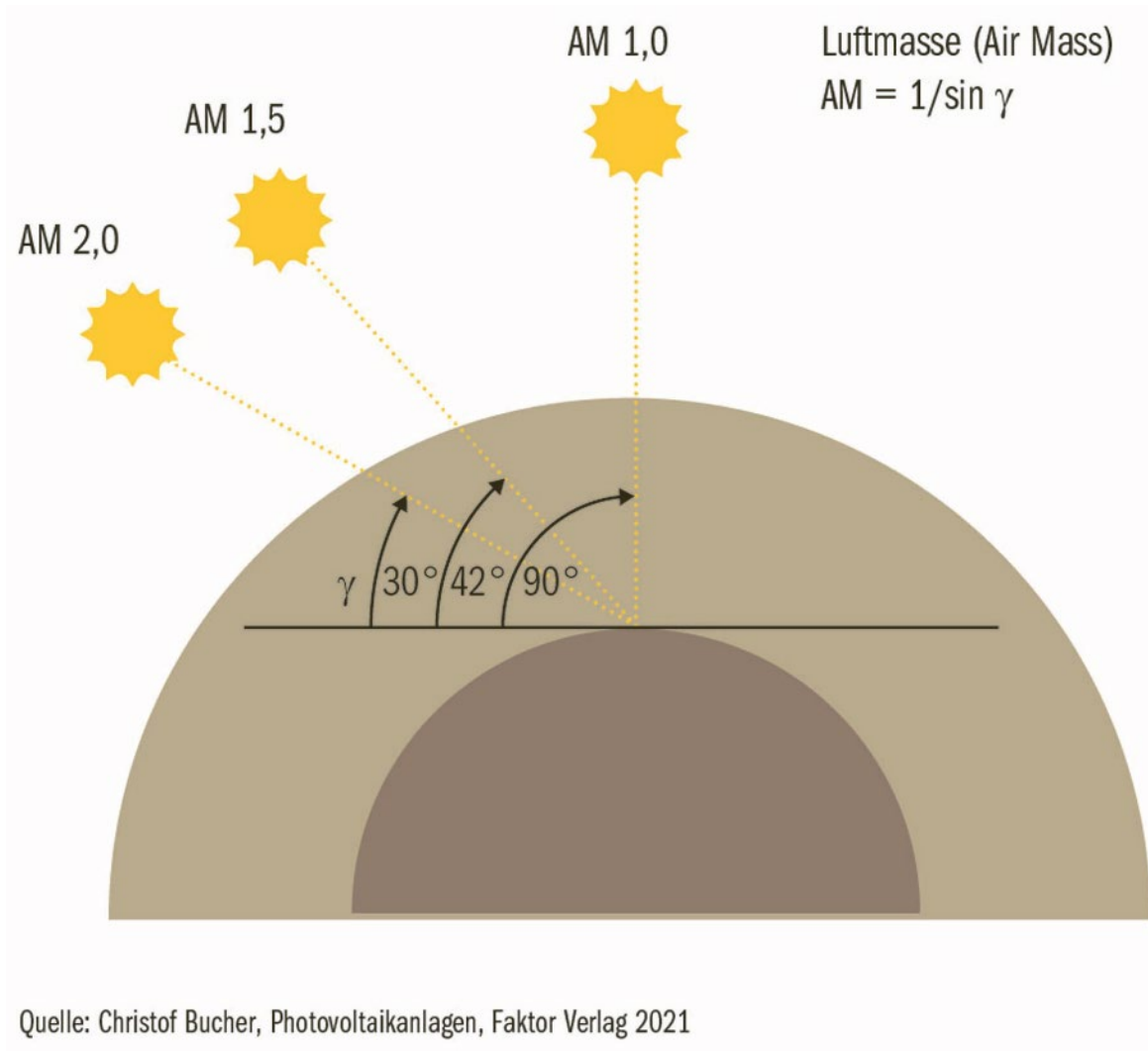

Neigungswinkel in Grad

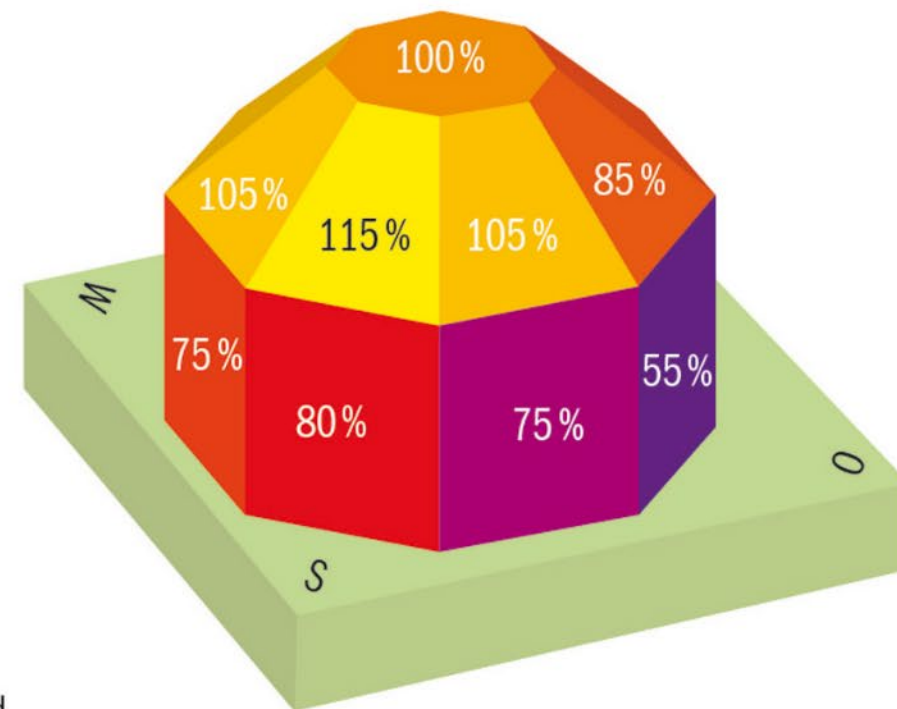
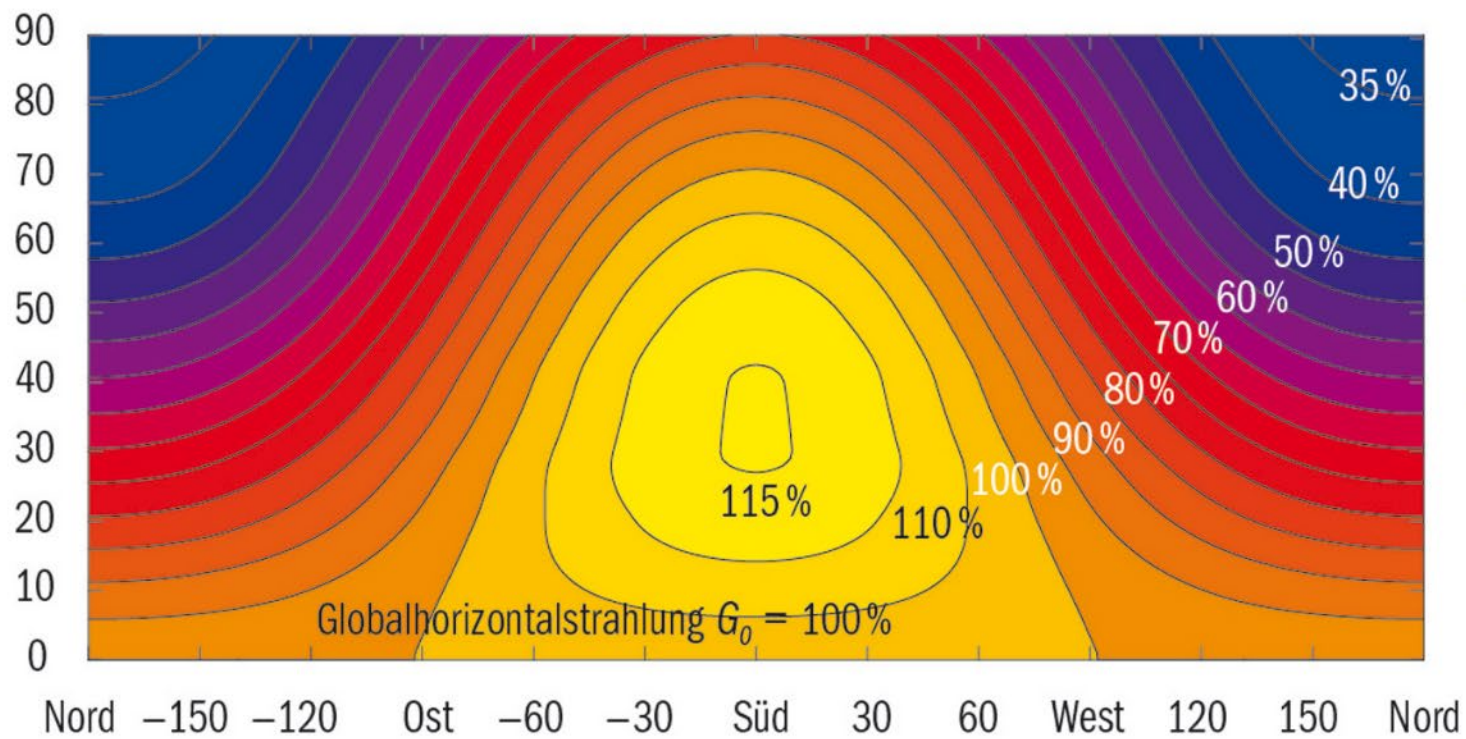

Quelle: Christof Bucher, Photovoltaikanlagen, Faktor Verlag 2021

Olten: Globalstrahlung in kWh/m²

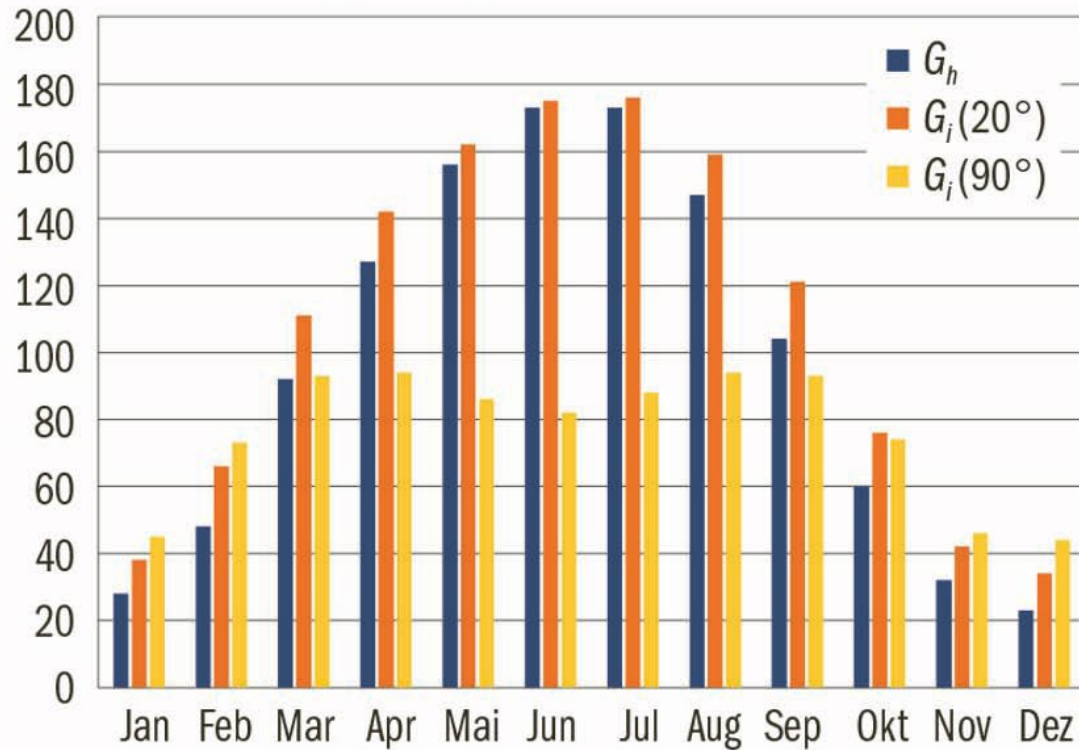

Davos: Globalstrahlung in kWh/m²

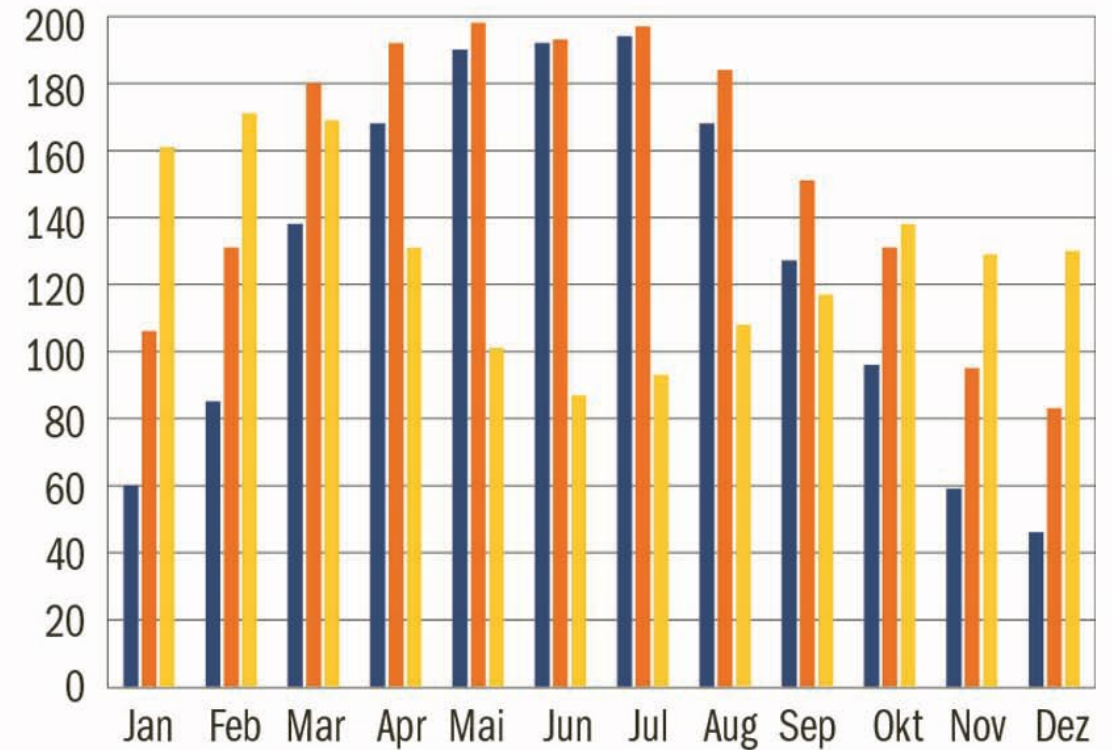

Quelle: Christof Bucher, Photovoltaikanlagen, Faktor Verlag 2021

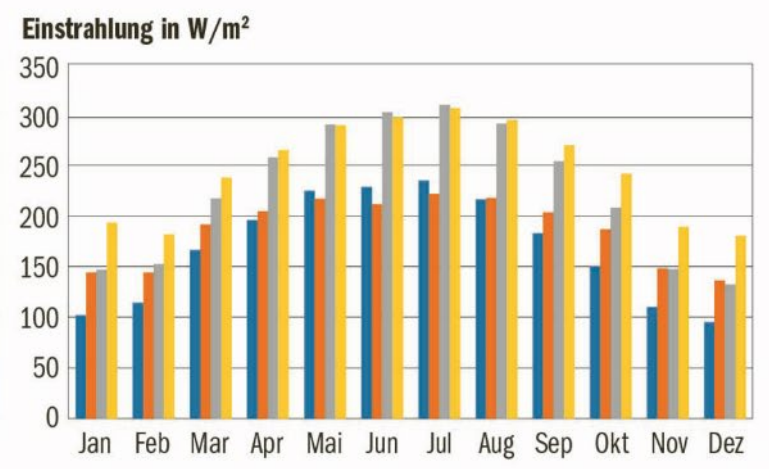
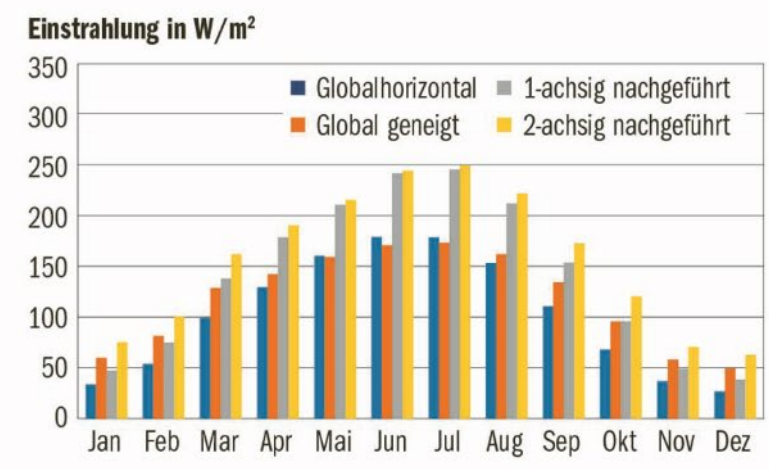
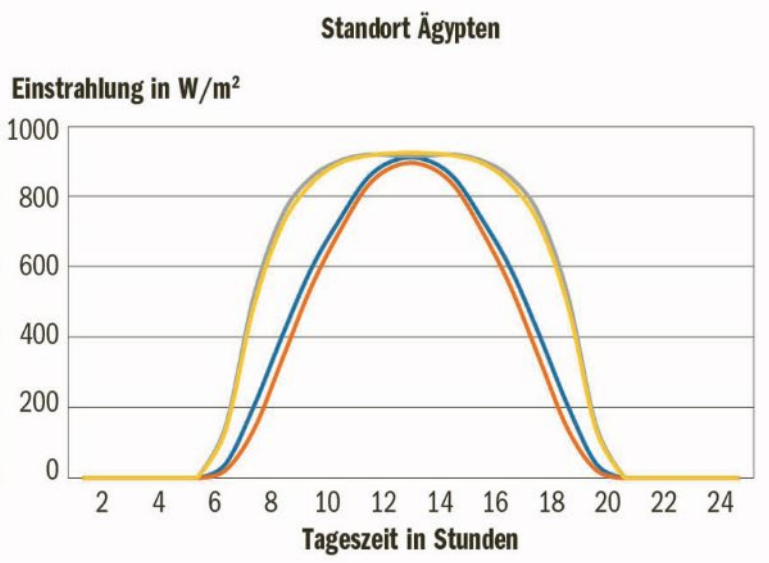
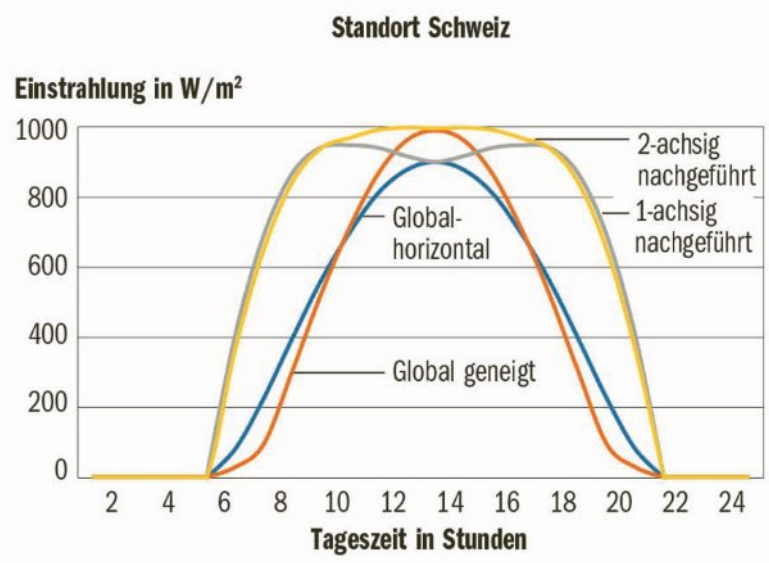

Quelle: Christof Bucher, Photovoltaikanlagen, Faktor Verlag 2021

90	Globalstrahlung Ebene um 20° nach Süden geneigt in kWh/m ² nach Himmelssektor (Bern, 1408 kWh/m ² /Jahr)																																					
80	0	0,2	0,4	0,5	0,5	0,6	0,3	0,5	0,5	0,3	0,5	0,5	0,5	0,6	0,6	0,6	0,8	0,5	0,5	0,8	0,6	0,6	0,6	0,5	0,5	0,5	0,3	0,5	0,5	0,3	0,6	0,5	0,5	0,4	0,2	0	17	
70	1,3	0,9	1,1	0,9	1,1	1,1	1,1	1,2	1,1	1,5	1,3	1,8	1,8	3,6	4,9	6,6	6,9	7,3	7,3	6,9	6,6	4,9	3,6	1,8	1,8	1,3	1,5	1,1	1,2	1,1	1,1	1,1	0,9	1,1	0,9	1,3	91	
60	1,3	1,4	1,1	1,2	1,2	1,3	1,3	1,6	2,5	3,9	5,7	7,2	8,1	9,7	10	10	10	10	10	10	10	10	10	9,7	8,1	7,2	5,7	3,9	2,5	1,6	1,3	1,3	1,2	1,2	1,1	1,4	1,3	176
50	1,7	1,4	1,2	1,3	1,3	1,4	1,5	2,6	4,2	6	8,3	10	11	12	13	13	13	13	13	13	13	13	12	11	10	8,3	6	4,2	2,6	1,5	1,4	1,3	1,3	1,2	1,4	1,7	232	
40	0,7	1,1	1,1	1,1	1,1	1,3	2	3,4	5,4	7,5	10	12	13	14	15	15	16	16	16	16	15	15	14	13	12	10	7,5	5,4	3,4	2	1,3	1,1	1,1	1,1	1,1	1,1	0,7	268
30	0,8	0,7	0,8	0,8	0,9	1,2	2,1	3,7	5,7	8	11	12	13	14	14	14	13	13	13	13	14	14	14	13	12	11	8	5,7	3,7	2,1	1,2	0,9	0,8	0,8	0,7	0,8	256	
20	0,2	0,4	0,5	0,5	0,5	0,9	1,8	3,4	5,4	7,4	8,9	9,8	10	10	10	10	10	10	10	10	10	10	10	9,8	8,9	7,4	5,4	3,4	1,8	0,9	0,5	0,5	0,5	0,4	0,2	201		
10	0	0,1	0,1	0,1	0,2	0,3	1,1	3,2	4,7	5,5	5,8	5,8	6,1	7,5	7,5	7,3	6,7	6,6	6,6	6,7	7,3	7,5	7,5	6,1	5,8	5,2	5,5	4,7	3,2	1,1	0,3	0,2	0,1	0,1	0,1	0	136	
0	0	0	0	0	0	0,2	0,3	0,6	0,9	1,4	1,7	2,2	2,2	1,9	1,7	1,2	0,8	0,8	0,8	0,8	1,2	1,7	1,9	2,2	2,2	1,7	1,4	0,9	0,6	0,3	0,2	0	0	0	0	0	32	
von	-180	-170	-160	-150	-140	-130	-120	-110	-100	-90	-80	-70	-60	-50	-40	-30	-20	-10	0	10	20	30	40	50	60	70	80	90	100	110	120	130	140	150	160	170		
bis	-170	-160	-150	-140	-130	-120	-110	-100	-90	-80	-70	-60	-50	-40	-30	-20	-10	0	10	20	30	40	50	60	70	80	90	100	110	120	130	140	150	160	170	180	1408	
	6	6	6	6	7	8	12	20	30	42	52	62	65	74	76	77	77	77	77	77	77	76	74	65	62	52	42	30	20	12	8	7	6	6	6	6	1408	

90	Globalstrahlung Südfassade in kWh/m ² nach Himmelssektor (Bern, 1016 kWh/m ² /Jahr)																																									
80	0	0	0	0	0	0	0	0	0,2	0,2	0,2	0,2	0,2	0,2	0,2	0,2	0,2	0,2	0,2	0,2	0,2	0,2	0,2	0,2	0,2	0	0	0	0	0	0	0	0	0	0	0	0	0	4			
70	0	0	0	0	0	0	0	0	0,4	0,5	0,7	0,7	1,8	2,5	3,7	4	4,2	4,2	4	3,7	2,5	1,8	0,7	0,7	0,5	0,4	0	0	0	0	0	0	0	0	0	0	0	0	0	0	37	
60	0	0	0	0	0	0	0	0	1,6	2,7	3,8	4,4	5,9	6,6	7	7,3	7,4	7,4	7,3	7	6,6	5,9	4,4	3,8	2,7	1,6	0	0	0	0	0	0	0	0	0	0	0	0	0	0	93	
50	0	0	0	0	0	0	0	0	2,5	4	5,6	6,3	8,4	9,4	10	11	11	11	11	10	9,4	8,4	6,3	5,6	4	2,5	0	0	0	0	0	0	0	0	0	0	0	0	0	0	0	135
40	0	0	0	0	0	0	0	0	3,2	5,2	7,1	8,1	11	12	13	14	15	15	14	13	12	11	8,1	7,1	5,2	3,2	0	0	0	0	0	0	0	0	0	0	0	0	0	0	0	178
30	0	0	0	0	0	0	0	0	3,7	6	8,4	9,5	13	14	14	14	14	14	14	14	14	13	9,5	8,4	6	3,7	0	0	0	0	0	0	0	0	0	0	0	0	0	0	0	193
20	0	0	0	0	0	0	0	0	3,7	5,5	7,7	8,6	11	12	12	13	12	12	13	12	12	11	8,6	7,7	5,5	3,7	0	0	0	0	0	0	0	0	0	0	0	0	0	0	0	171
10	0	0	0	0	0	0	0	0	2,6	4,2	6,6	7,5	11	12	11	11	10	10	11	11	12	11	7,5	6,6	4,2	2,6	0	0	0	0	0	0	0	0	0	0	0	0	0	0	0	151
0	0	0	0	0	0	0	0	0	1,7	2,7	3,9	4,1	4,2	3,6	3	2	1,8	1,8	2	3	3,6	4,2	4,1	3,9	2,7	1,7	0	0	0	0	0	0	0	0	0	0	0	0	0	0	0	54
von	-180	-170	-160	-150	-140	-130	-120	-110	-100	-90	-80	-70	-60	-50	-40	-30	-20	-10	0	10	20	30	40	50	60	70	80	90	100	110	120	130	140	150	160	170						
bis	-170	-160	-150	-140	-130	-120	-110	-100	-90	-80	-70	-60	-50	-40	-30	-20	-10	0	10	20	30	40	50	60	70	80	90	100	110	120	130	140	150	160	170	180	1016					
	0	0	0	0	0	0	0	0	20	31	44	49	66	72	75	76	76	76	76	75	72	66	49	44	31	20	0	0	0	0	0	0	0	0	0	0	0	0	0	1016		

Quelle: Christof Bucher, Photovoltaikanlagen, Faktor Verlag 2021

90	Globalstrahlung 20° nach Westen geneigt in kWh/m ² nach Himmelssektor (Bem, 1211 kWh/m ² /Jahr)																																				
80	0	0,3	0,3	0,2	0	0,2	0,2	0,2	0,4	0,4	0,4	0,4	0,4	0,2	0,4	0,2	0,4	0,7	0,7	0,7	0,7	0,7	0,4	0,4	0,7	0,7	0,7	0,9	1,1	0,9	0,9	0,7	0,7	0,4	0,3	0	17
70	0	0,4	0,5	0,2	0,2	0,2	0,5	0,5	0,6	0,6	0,9	0,9	1,1	2,1	3,2	4,7	5,4	6	6,1	6,2	6,4	5,1	4,1	2,5	2,2	2	2,2	2,2	2	2,2	2,2	1,7	2,1	2	2,2	83	
60	0,2	0,3	0,4	0,5	0,4	0,5	0,5	0,6	1,2	2,1	3,1	4,3	5,6	6,2	6,7	7,1	7,4	7,7	8,2	8,7	8,9	9,5	9,6	9,5	8,3	7,1	5,3	4,1	3,1	2,7	2,8	2,7	2,7	2,6	3,1	3,7	157
50	0,4	0,6	0,5	0,5	0,5	0,5	0,6	1,1	1,9	3	4,3	5,6	6,7	7,4	8	8,5	9	9,4	10	11	11	12	12	12	12	10	8,1	6,4	4,8	3,2	3,1	3,1	3,1	3	3,4	3,7	201
40	0,7	0,6	0,6	0,6	0,5	0,5	0,8	1,3	2,1	3,3	4,6	5,8	7	7,8	8,5	9,2	9,9	11	12	12	13	14	14	14	14	13	11	8,5	6,3	4,3	3,3	3,1	3	2,9	2,9	3	227
30	0,9	0,8	0,5	0,4	0,4	0,4	0,6	1,1	2	3,1	4,4	5,6	6,4	6,8	7,1	7,2	7,5	8	8,9	10	11	13	14	15	15	14	12	9,8	7,3	5	3,6	2,7	2,4	2,3	2	1,9	212
20	0,7	0,5	0,4	0,3	0,3	0,3	0,4	1	1,8	2,7	3,2	3,8	4	4,1	4,2	4,7	5,2	5,8	6,6	7,4	8,2	9,2	10	11	12	12	11	9,7	7,2	4,9	3,3	2,2	1,8	1,7	1,4	1,5	166
10	0,4	0,2	0,1	0,1	0,1	0,1	0,1	0,5	0,7	0,9	0,7	0,7	0,9	1,2	1,6	2,1	2,5	3,1	3,7	4,6	5,7	6,9	7,9	8	8,1	8,1	10	11	9	4,9	2	1,2	1	1	0,7	0,7	110
0	0	0	0	0	0	0	0	0	0	0	0	0	0	0	0	0	0,2	0,2	0,2	0,4	1,1	1,6	2,2	3,1	3,4	3,4	3,6	4,3	3,6	3,1	2,7	1,8	0,7	0,4	0,3	0	36
von	-180	-170	-160	-150	-140	-130	-120	-110	-100	-90	-80	-70	-60	-50	-40	-30	-20	-10	0	10	20	30	40	50	60	70	80	90	100	110	120	130	140	150	160	170	
bis	-170	-160	-150	-140	-130	-120	-110	-100	-90	-80	-70	-60	-50	-40	-30	-20	-10	0	10	20	30	40	50	60	70	80	90	100	110	120	130	140	150	160	170	180	1211
	3	4	3	3	2	3	4	6	11	16	22	27	32	36	40	44	48	52	56	61	66	71	74	76	75	71	64	57	44	31	24	20	17	16	16	17	1211

90	Globalstrahlung Westfassade in kWh/m ² nach Himmelssektor (Bern, 805 kWh/m ² /Jahr)																																					
80	0	0	0	0	0	0	0	0	0	0	0	0	0	0	0	0	0,5	0,2	0,2	0,5	0,5	0,2	0,2	0,2	0	0	0	0,5	0,5	0,5	0,5	0,7	0,2	0,3	0	6		
70	0	0	0	0	0	0	0	0	0	0	0	0	0	0	0	0	0,7	0,9	1,6	2,2	2,2	1,9	1,3	1,2	1,1	1,2	1,2	1,2	1,6	1,3	1,3	0,8	0,9	0,8	0,7	24		
60	0	0	0	0	0	0	0	0	0	0	0	0	0	0	0	0	1,4	1,9	2,7	3,8	4,9	5,8	6,4	6	5,2	4,4	3,3	2,6	2,3	2,1	1,9	1,8	1,3	1,2	1	60		
50	0	0	0	0	0	0	0	0	0	0	0	0	0	0	0	0	1,7	2,6	3,8	5,2	6,8	8	9,2	9,7	9,1	7,7	6,2	4,7	3,1	2,7	2,3	2,1	1,6	1,5	1	89		
40	0	0	0	0	0	0	0	0	0	0	0	0	0	0	0	0	2,2	3,4	5	6,7	8,9	10	12	13	13	12	9,5	7,4	5,1	3,2	2,6	2,4	1,8	1,5	1	121		
30	0	0	0	0	0	0	0	0	0	0	0	0	0	0	0	0	2	3,2	5,2	7,6	10	12	14	16	16	15	13	10	7,1	4,5	2,6	2,3	1,7	1,2	0,7	144		
20	0	0	0	0	0	0	0	0	0	0	0	0	0	0	0	0	1,6	2,7	4,5	6,5	8,9	11	13	15	16	16	14	11	7,8	5	3	2	1,4	0,9	0,3	140		
10	0	0	0	0	0	0	0	0	0	0	0	0	0	0	0	0	0,8	1,7	3,5	6,1	8,9	11	13	13	14	17	18	16	9,4	4,2	2	1,5	1,3	0,7	0	142		
0	0	0	0	0	0	0	0	0	0	0	0	0	0	0	0	0	0	0,2	0,5	1,9	3,6	5,1	6,5	7,5	7,7	7,7	9,7	8,7	7,7	6,3	4,8	1,5	0,7	0,3	0	80		
von	-180	-170	-160	-150	-140	-130	-120	-110	-100	-90	-80	-70	-60	-50	-40	-30	-20	-10	0	10	20	30	40	50	60	70	80	90	100	110	120	130	140	150	160	170		
bis	-170	-160	-150	-140	-130	-120	-110	-100	-90	-80	-70	-60	-50	-40	-30	-20	-10	0	10	20	30	40	50	60	70	80	90	100	110	120	130	140	150	160	170	180	805	
	0	0	0	0	0	0	0	0	0	0	0	0	0	0	0	0	0	0	0	0	0	0	0	0	0	0	0	0	0	0	0	0	0	0	0	0	0	805

Quelle: Christof Bucher, Photovoltaikanlagen, Faktor Verlag 2021

Jahresdurchschnitt: Ertragsverlust in %

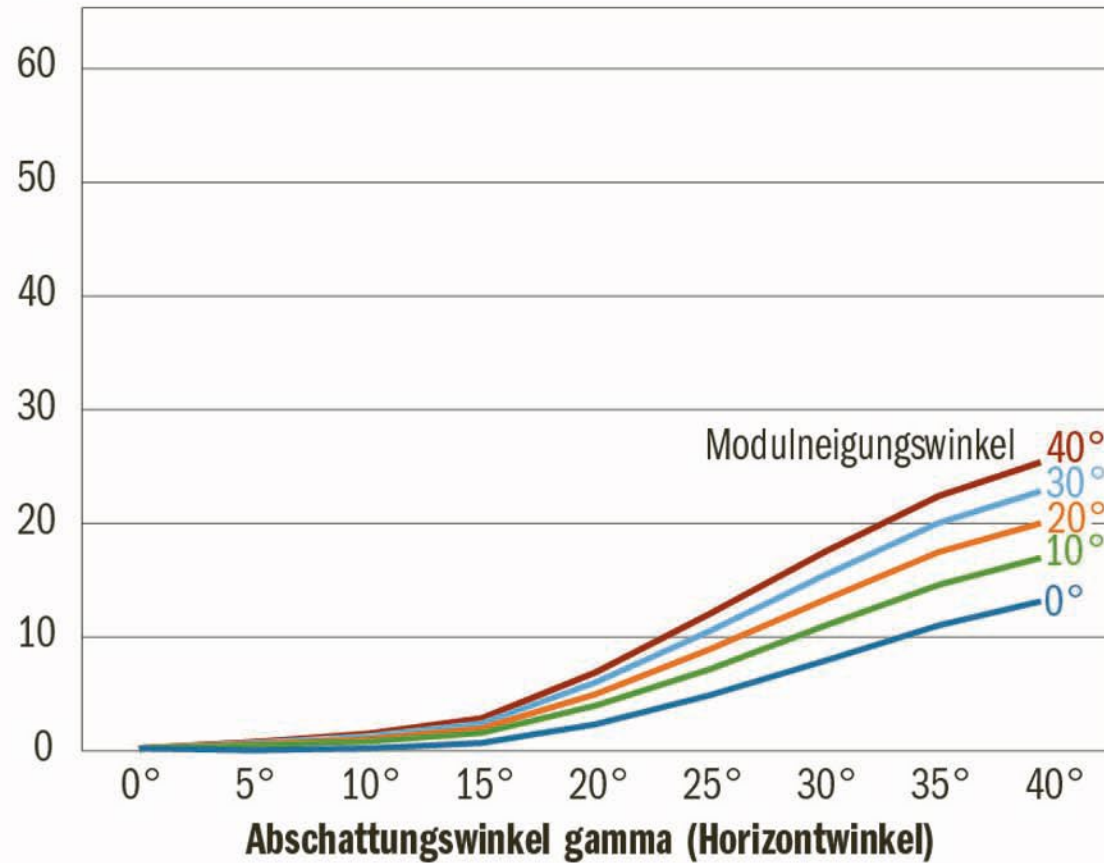

Wintermonate: Ertragsverlust in %

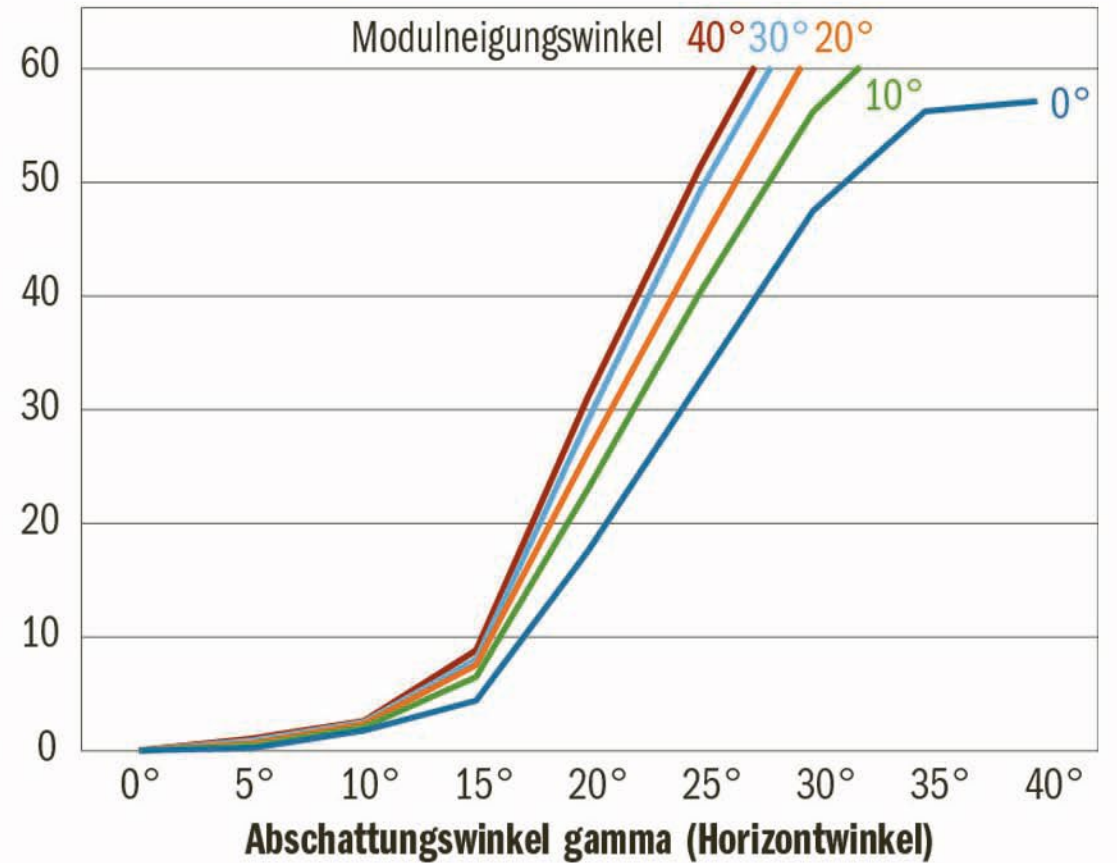

Quelle: Christof Bucher, Photovoltaikanlagen, Faktor Verlag 2021

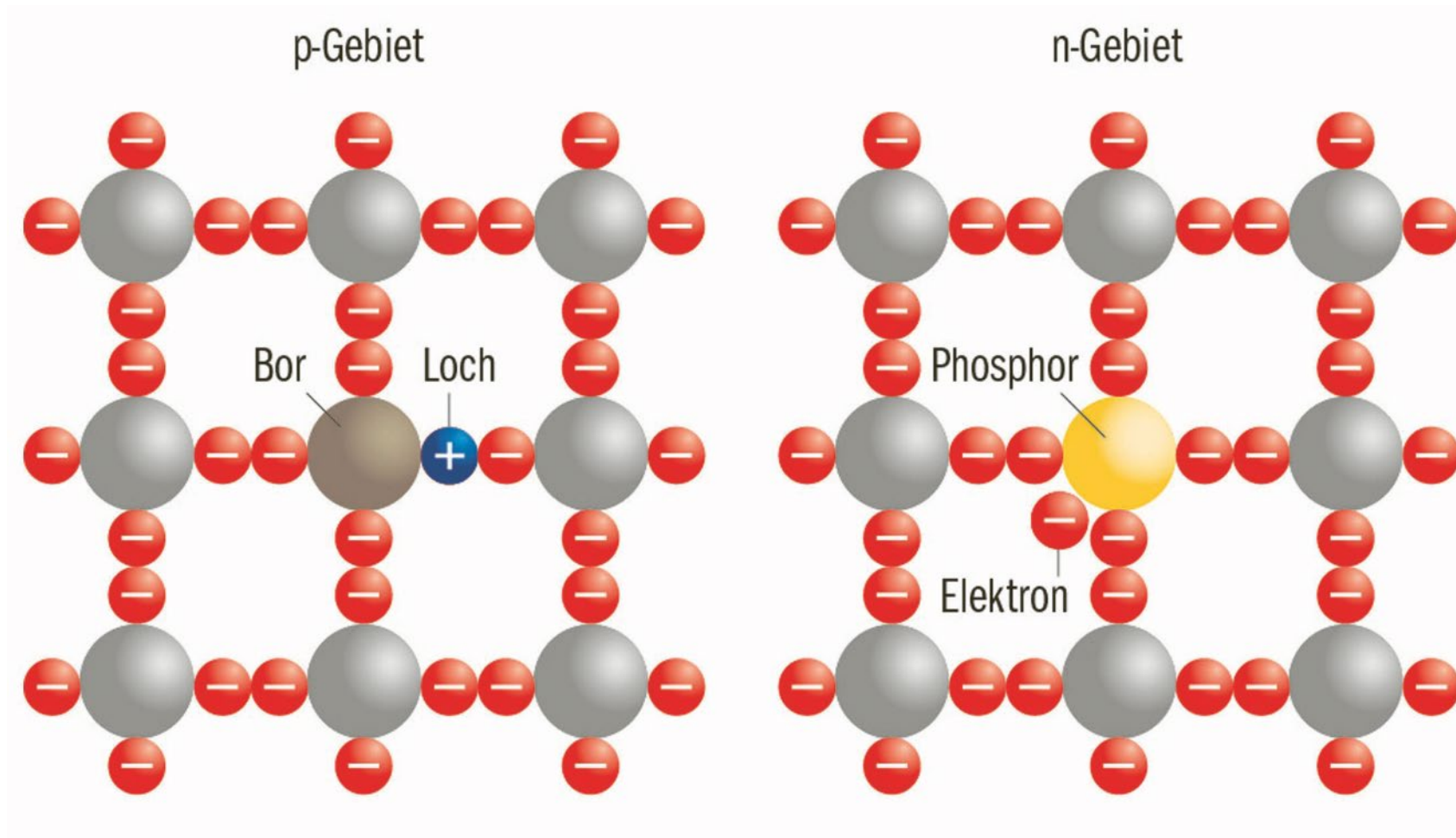

Quelle: Christof Bucher, Photovoltaikanlagen, Faktor Verlag 2021

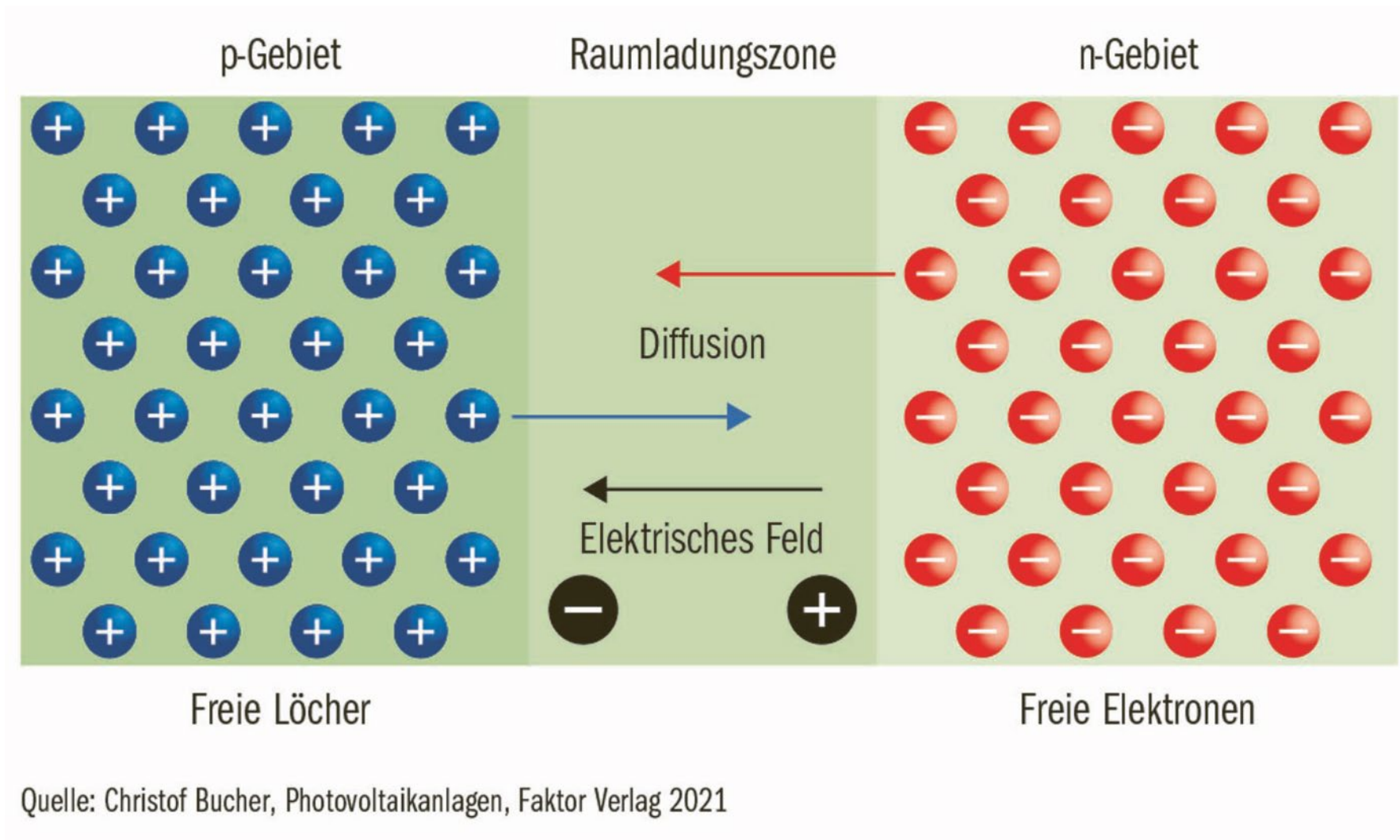

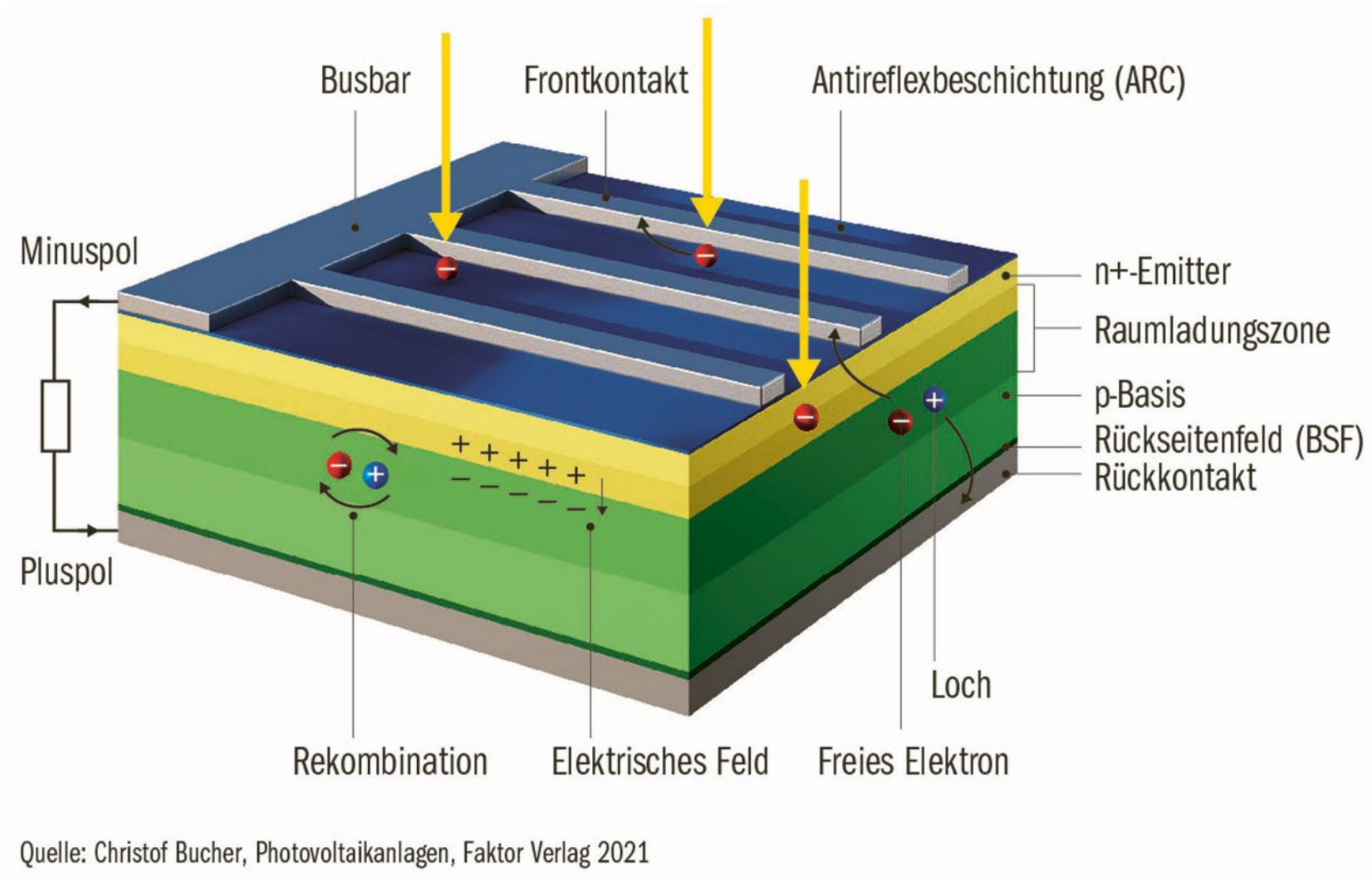

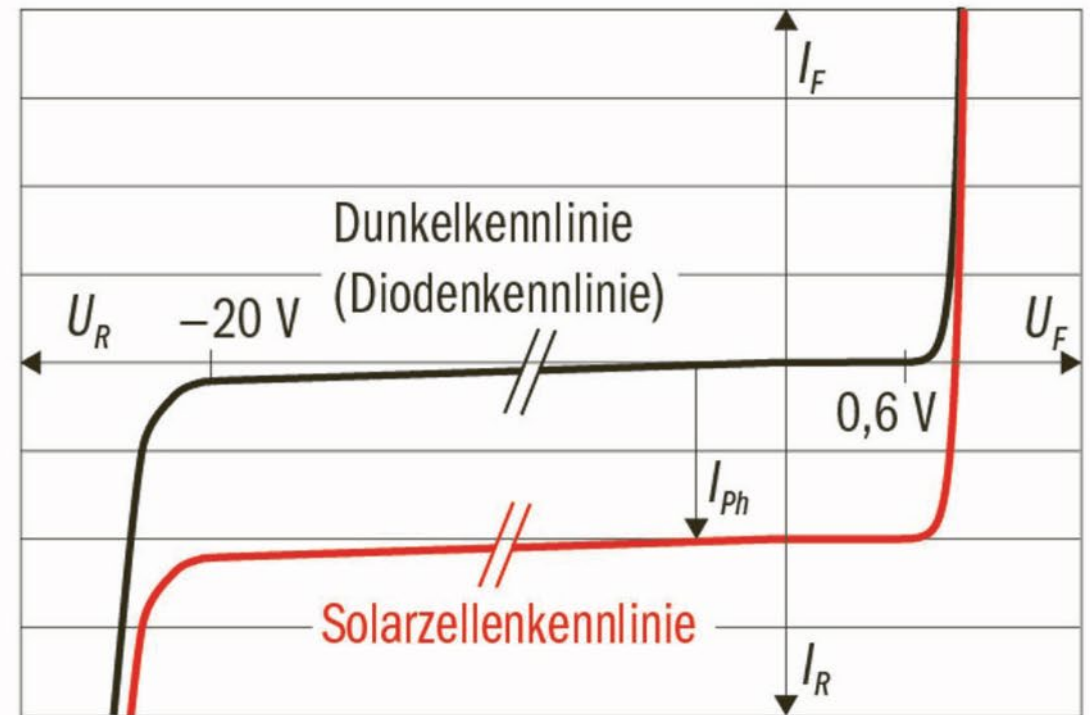
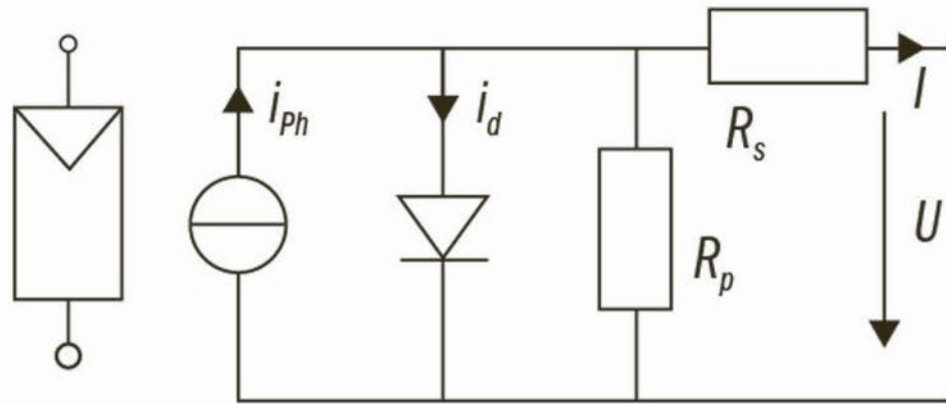

Quelle: Christof Bucher, Photovoltaikanlagen, Faktor Verlag 2021

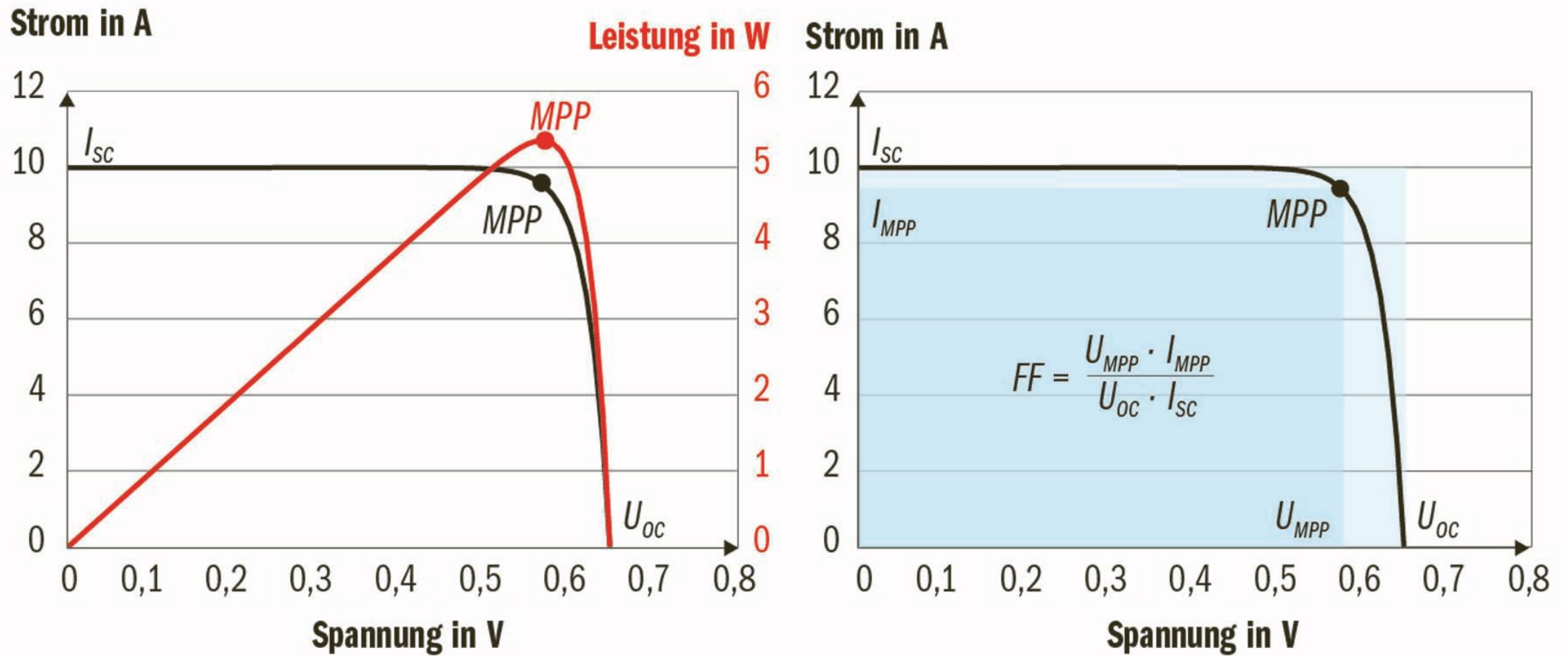

Quelle: Christof Bucher, Photovoltaikanlagen, Faktor Verlag 2021

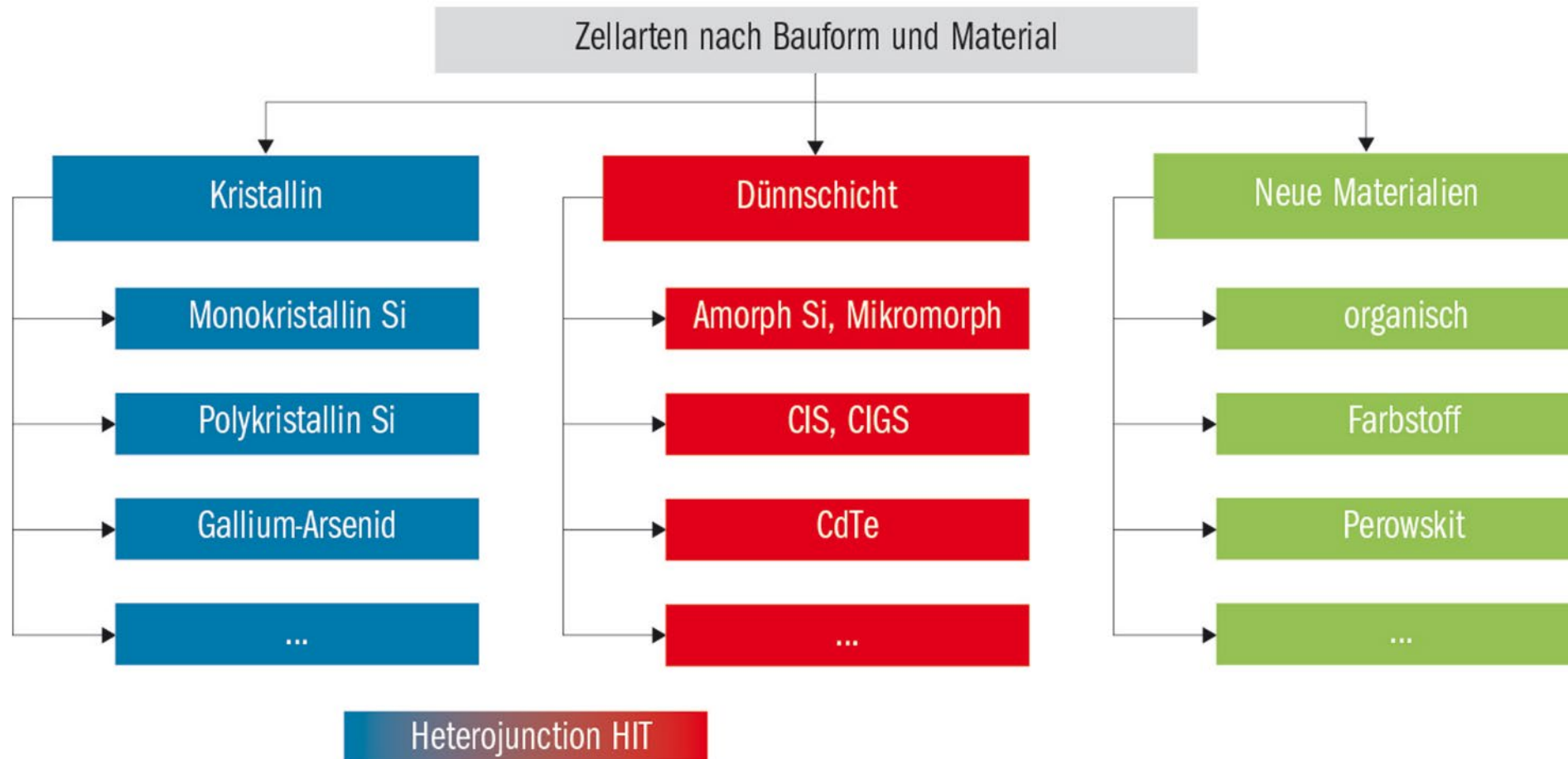

Quelle: Christof Bucher, Photovoltaikanlagen, Faktor Verlag 2021

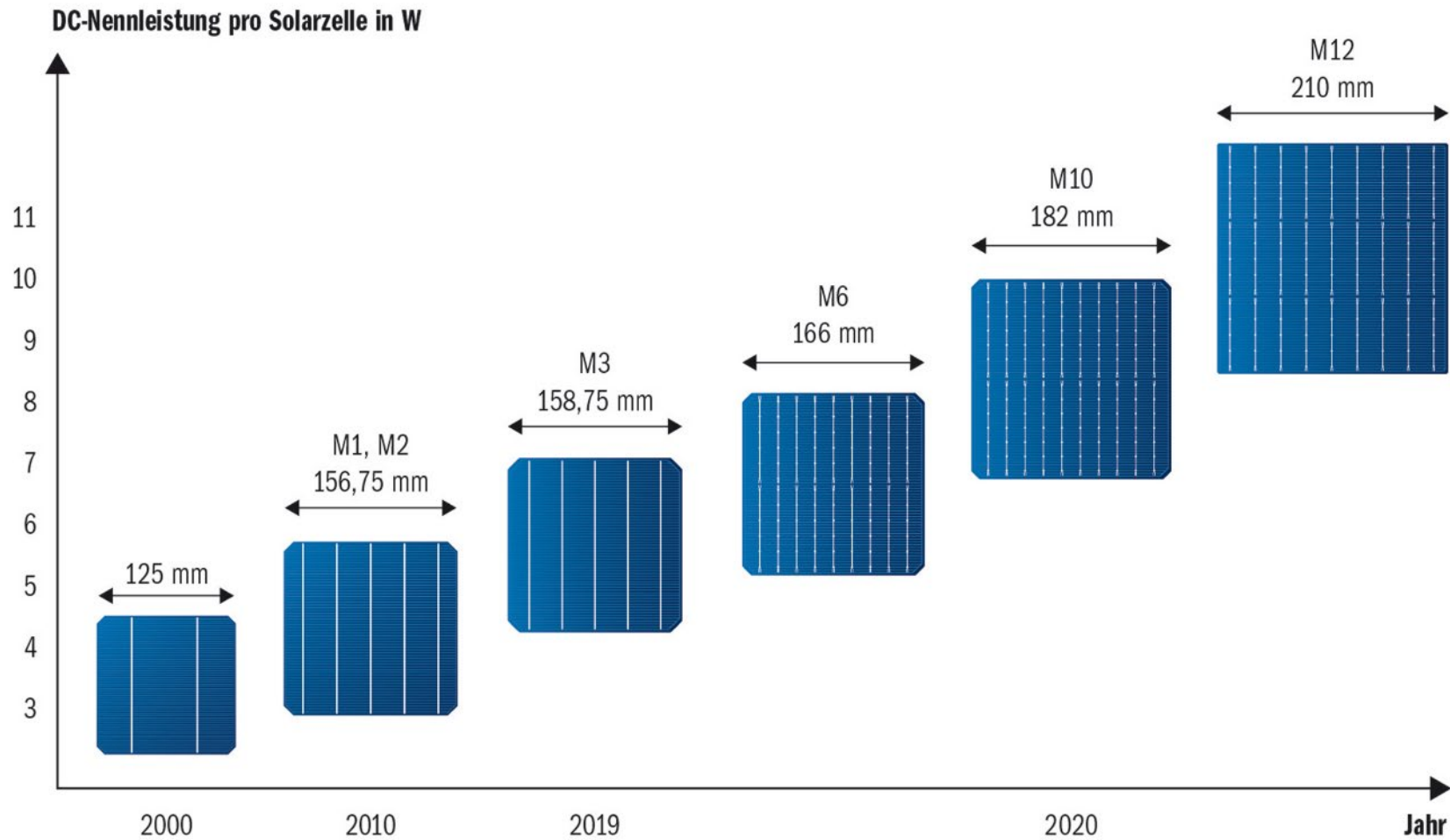

Quelle: Christof Bucher, Photovoltaikanlagen, Faktor Verlag 2021

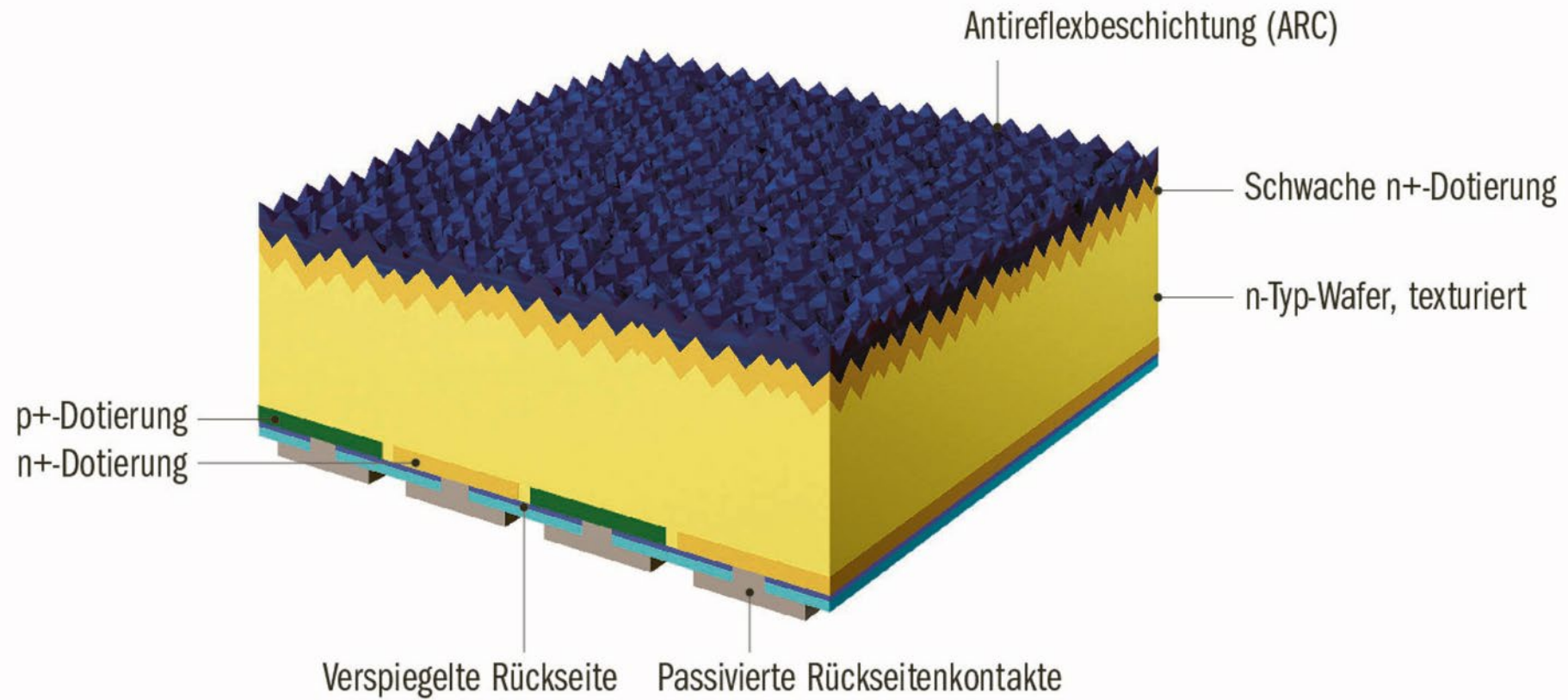

Quelle: Christof Bucher, Photovoltaikanlagen, Faktor Verlag 2021

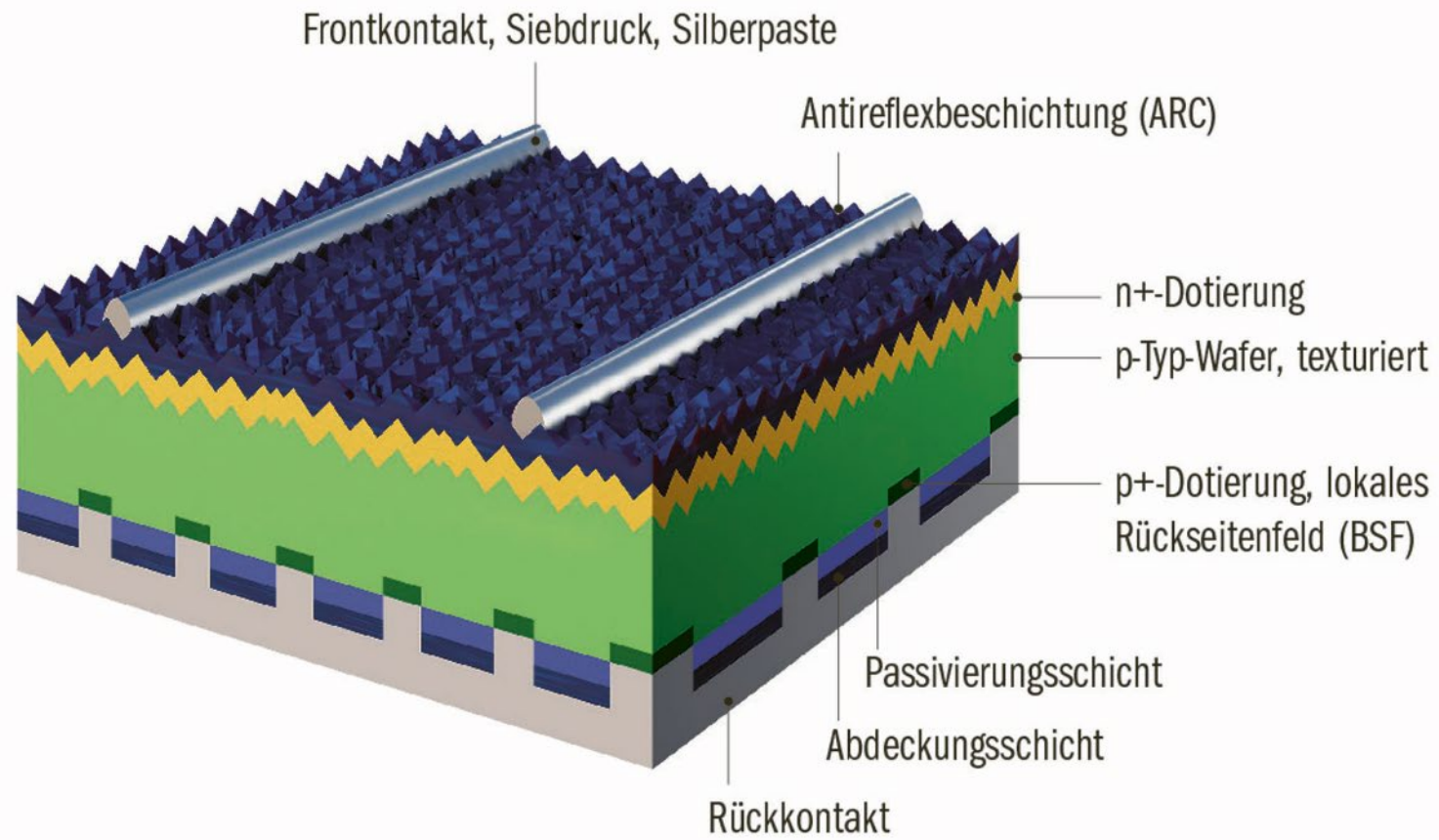

Quelle: Christof Bucher, Photovoltaikanlagen, Faktor Verlag 2021

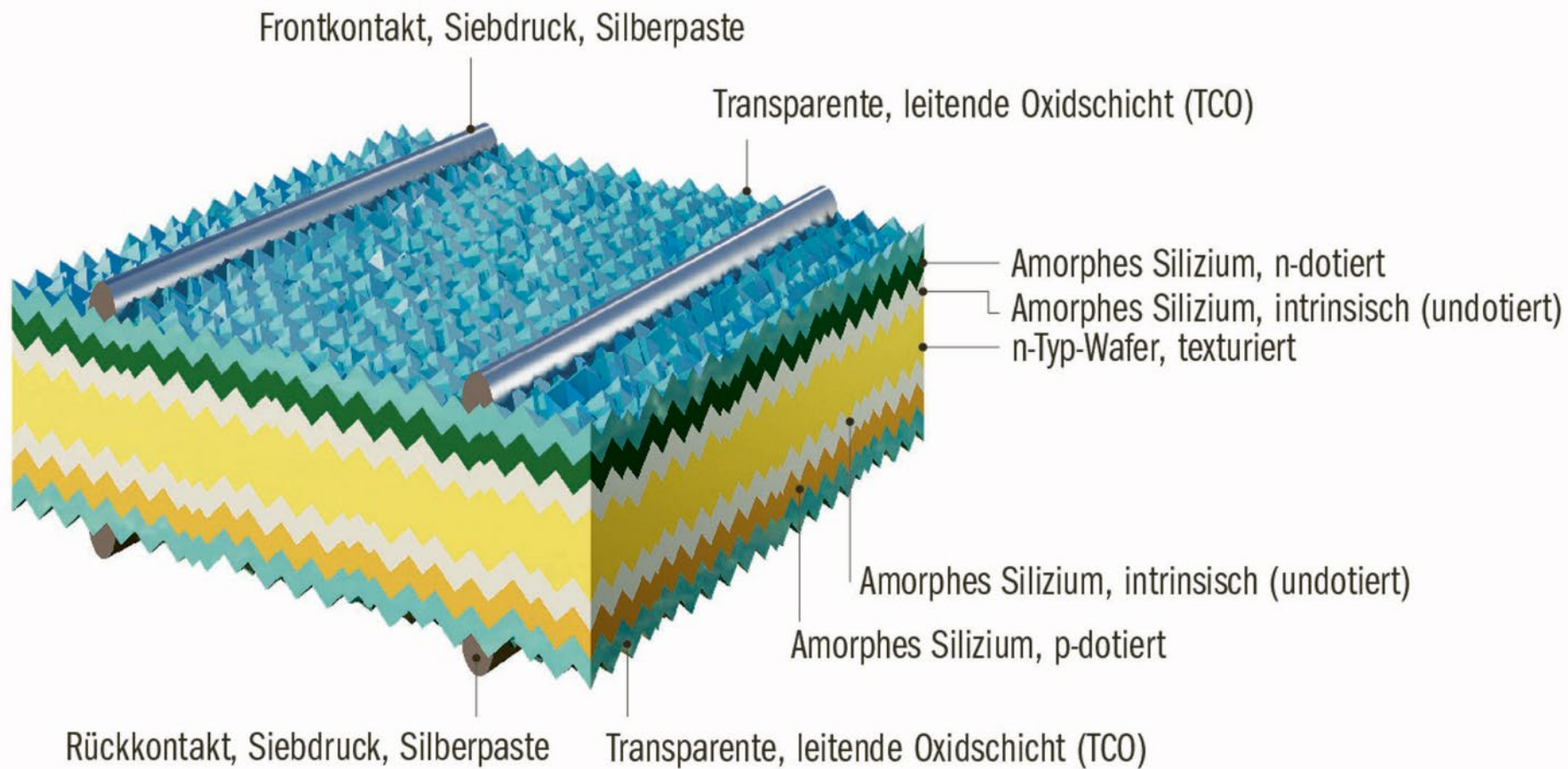

Quelle: Christof Bucher, Photovoltaikanlagen, Faktor Verlag 2021

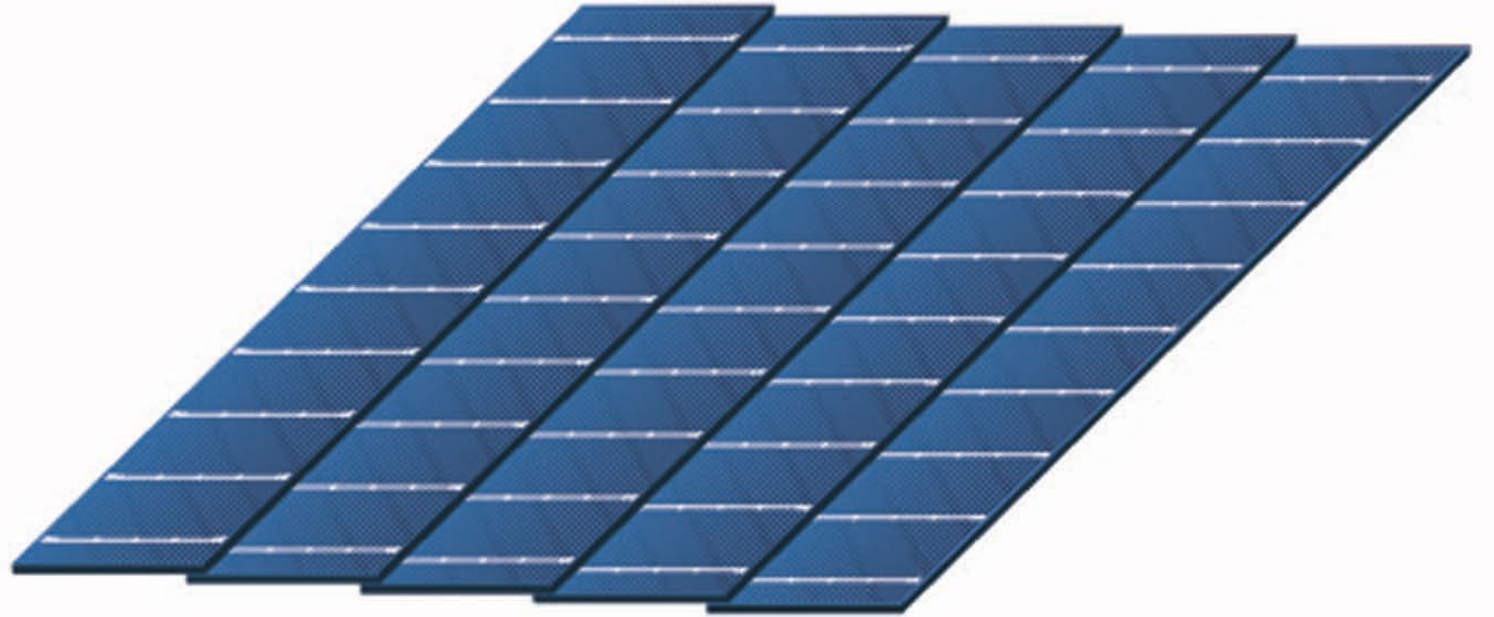
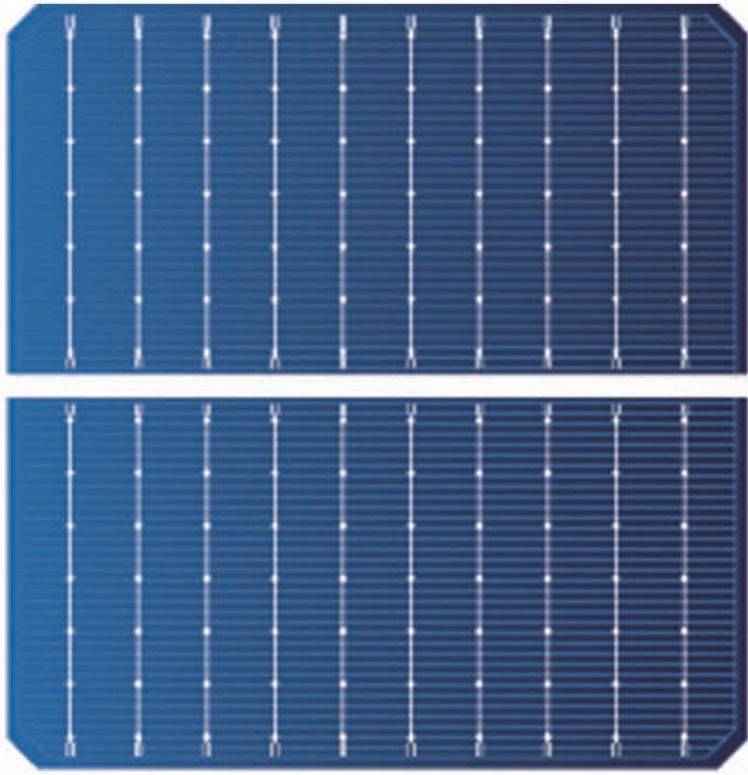

Quelle: Christof Bucher, Photovoltaikanlagen, Faktor Verlag 2021

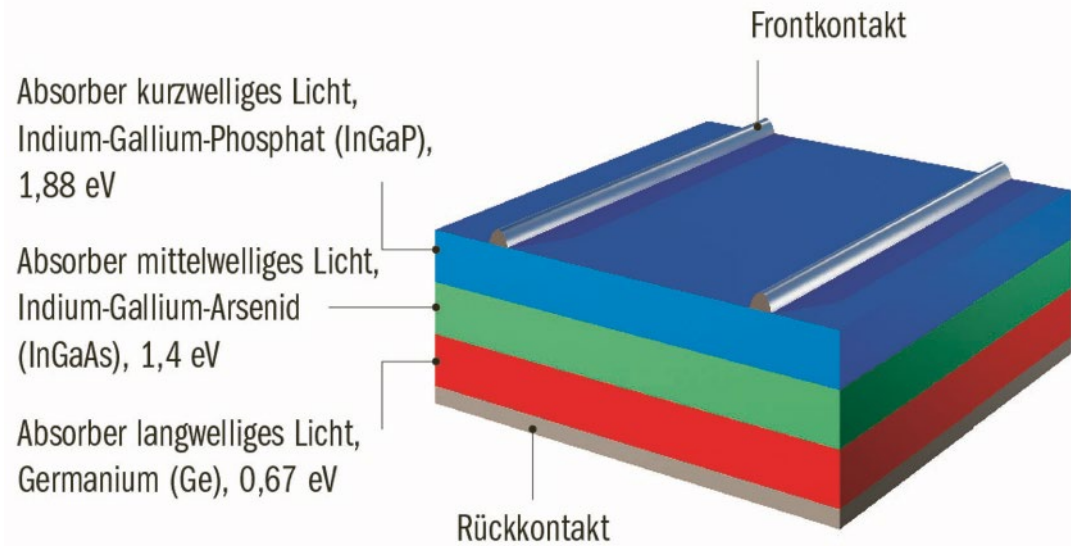

Einstrahlung in W/m²/nm

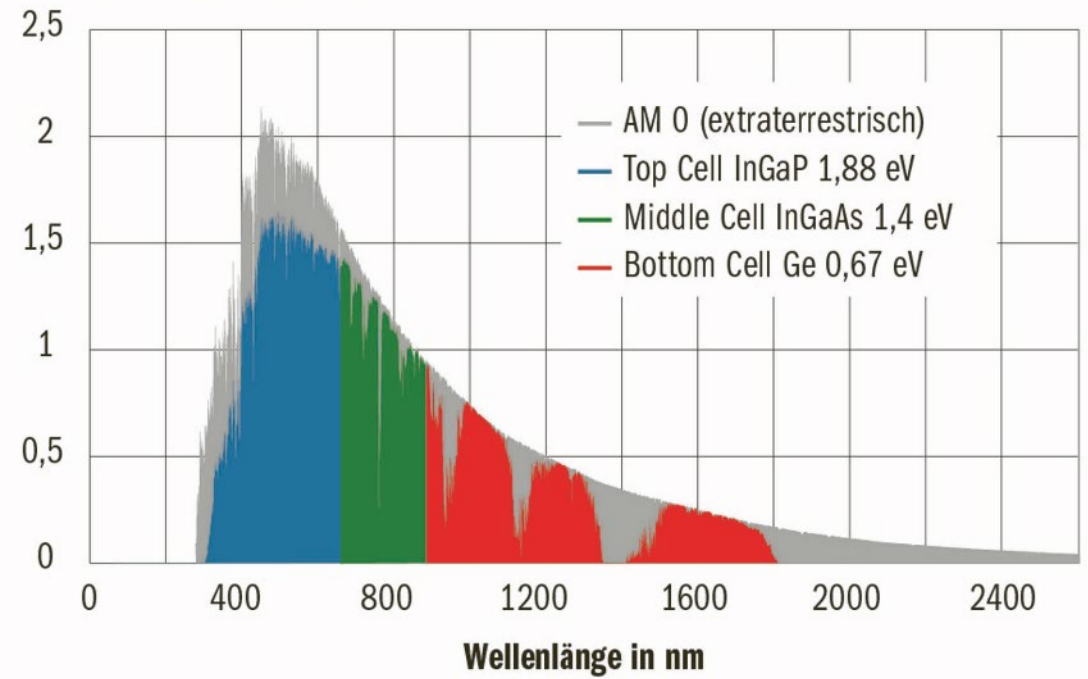

Quelle: Christof Bucher, Photovoltaikanlagen, Faktor Verlag 2021

Die Herstellung von Dünnschichtmodulen

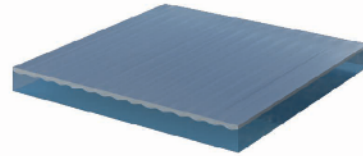

1 Auf ein geätztes Trägerglas wird der transparente, leitende Frontkontakt (TCO) aufgebracht.

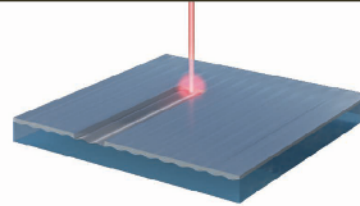

2 Mittels Laser wird das TCO in einzelne Zellen unterteilt.

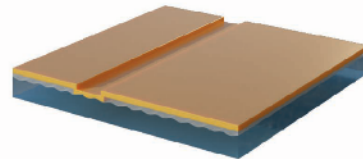

3 Die Zellschichten werden mit dem Verfahren «Plasma-Enhanced Chemical Vapour Deposition» (PECVD) auf das TCO abgeschieden.

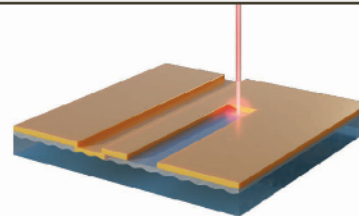

4 Wiederum mit Laser werden die Zellschichten strukturiert.

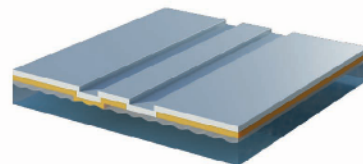

5 Der Rückseitenkontakt wird mit Sputtern aufgetragen.

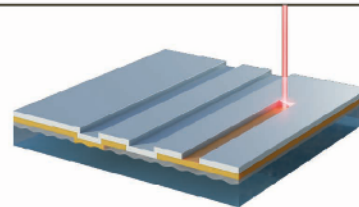

6 Die Rückkontakte werden zu Zellen gelasert.

Quelle: Christof Bucher, Photovoltaikanlagen, Faktor Verlag 2021

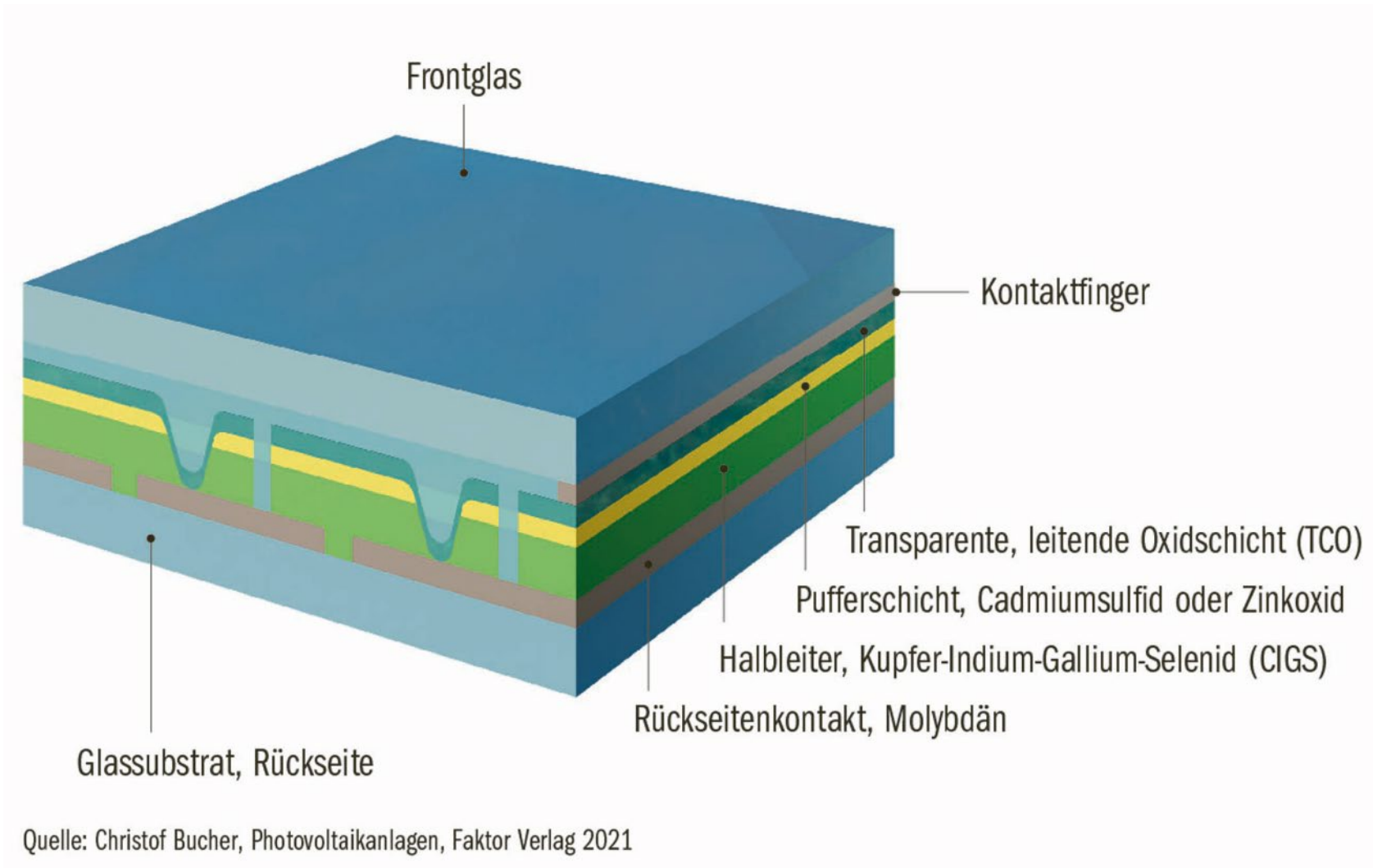

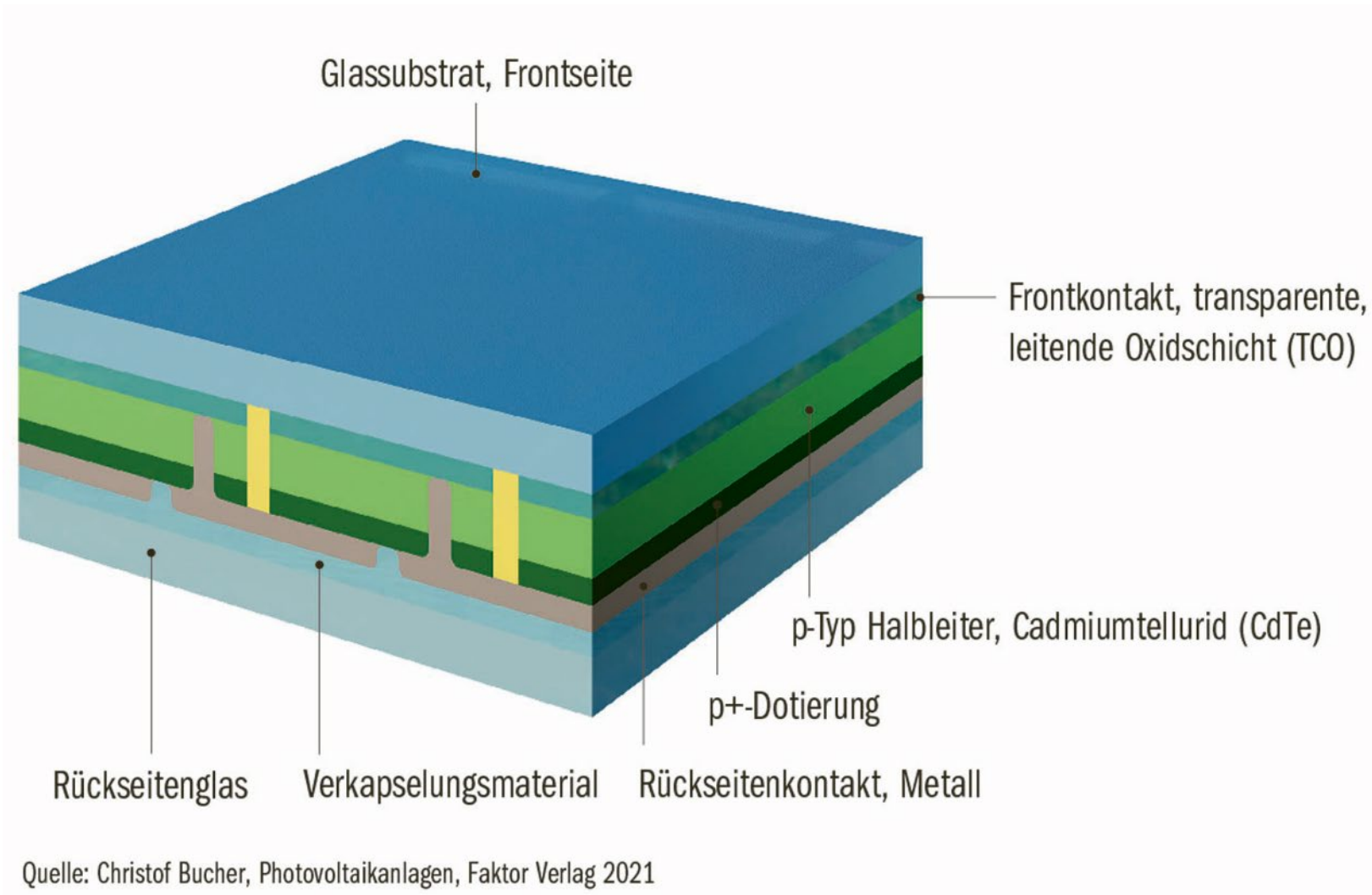

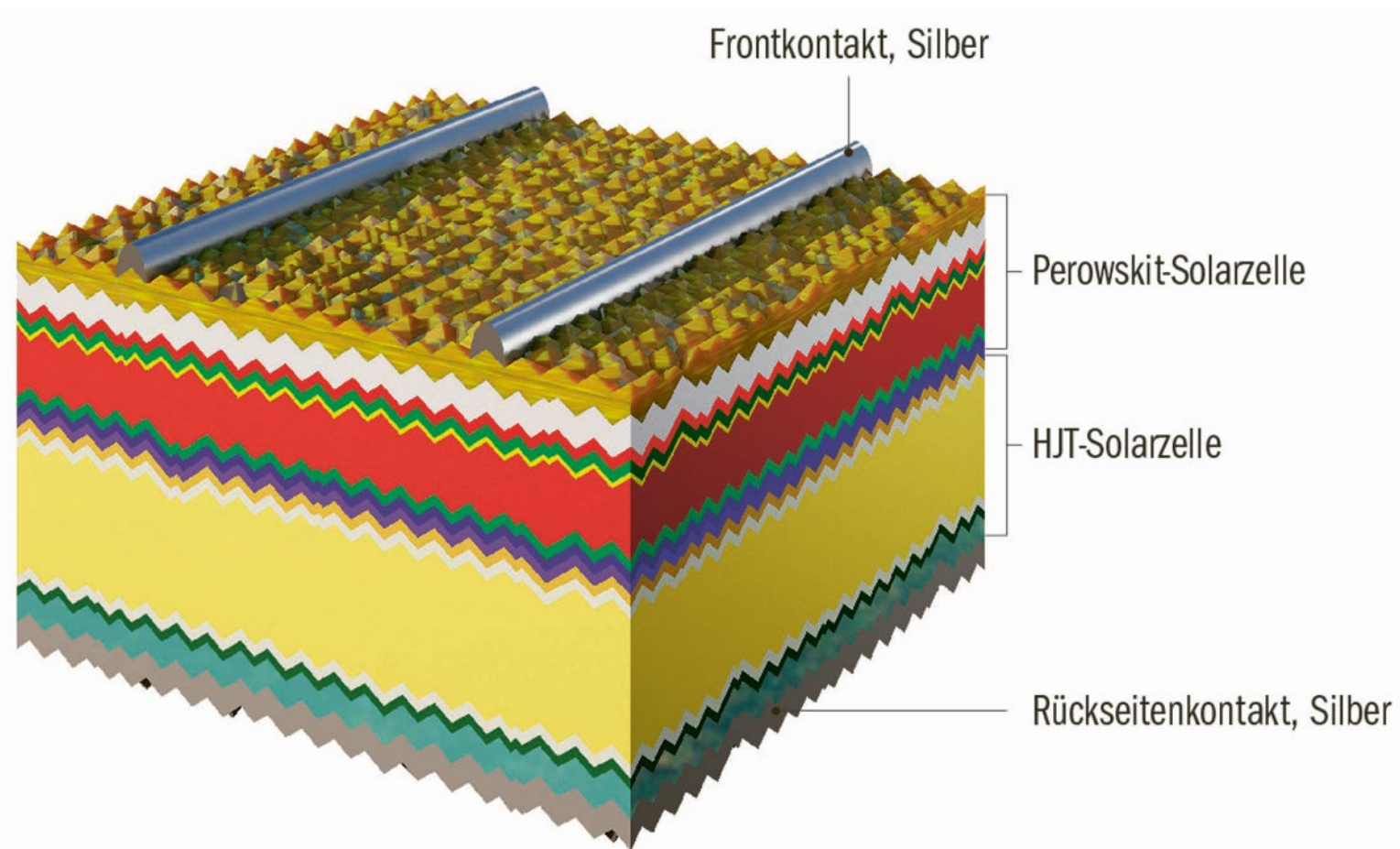

Quelle: Christof Bucher, Photovoltaikanlagen, Faktor Verlag 2021

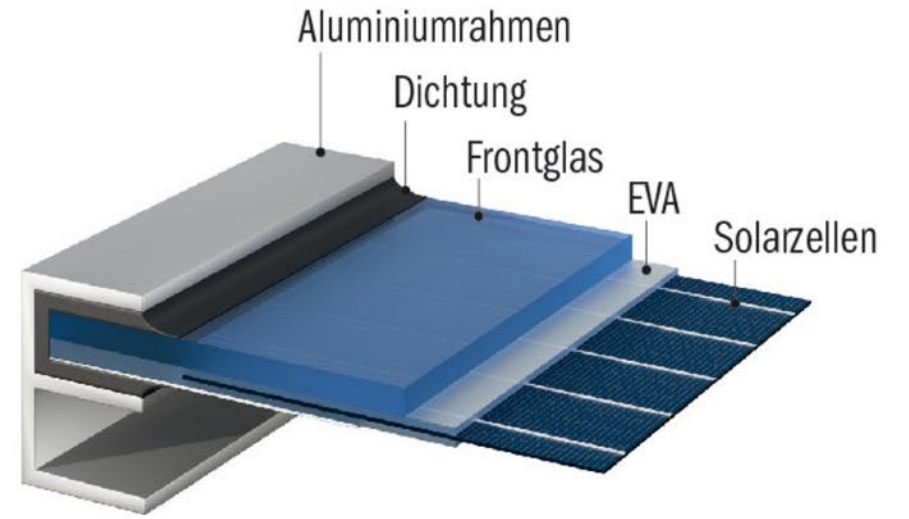
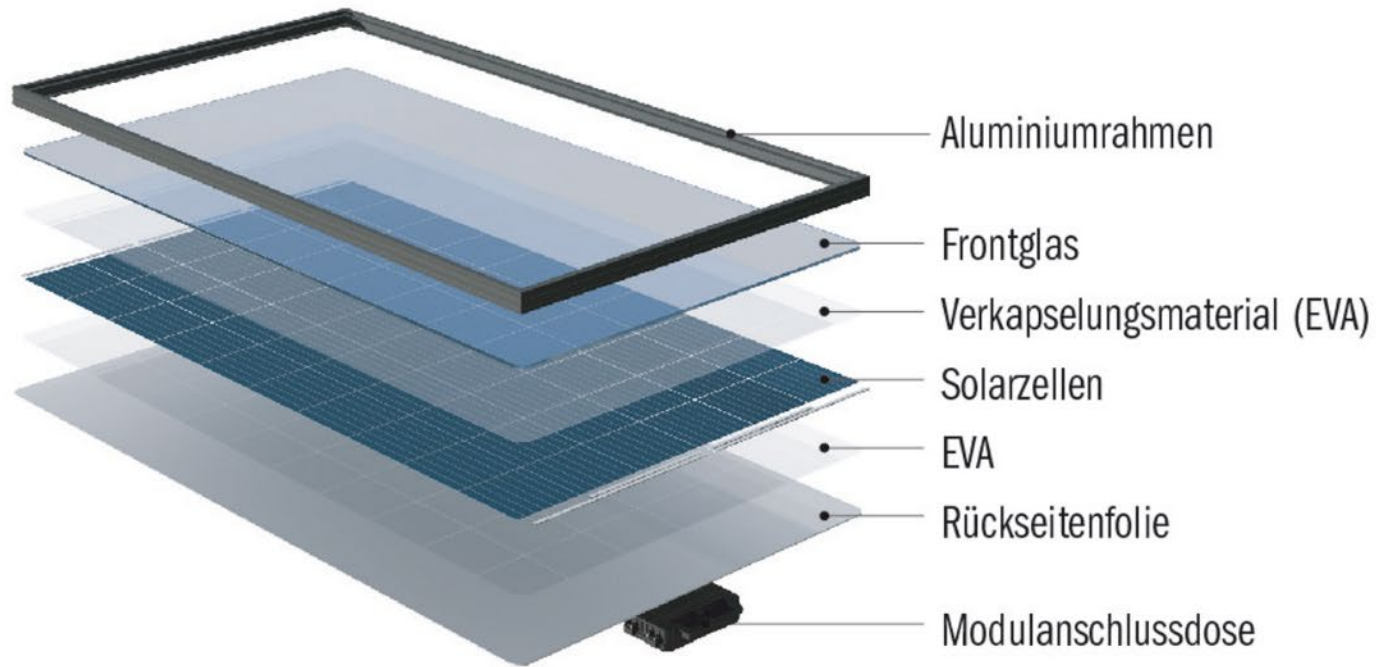

Quelle: Christof Bucher, Photovoltaikanlagen, Faktor Verlag 2021

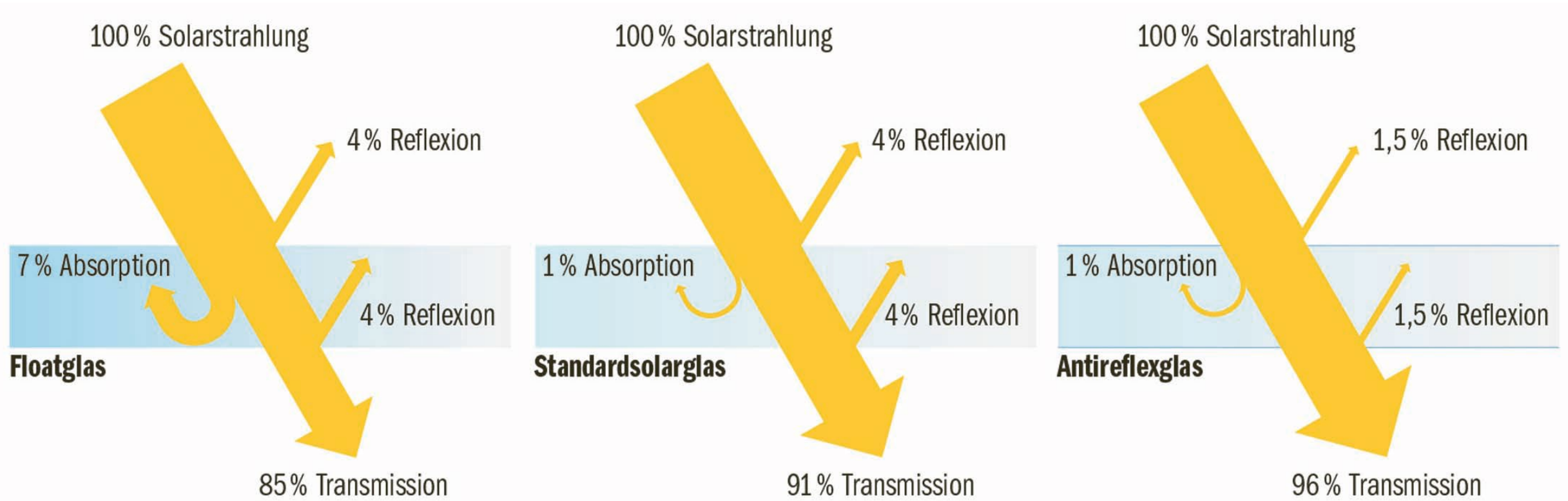

Quelle: Christof Bucher, Photovoltaikanlagen, Faktor Verlag 2021

Incident Angle Modifier

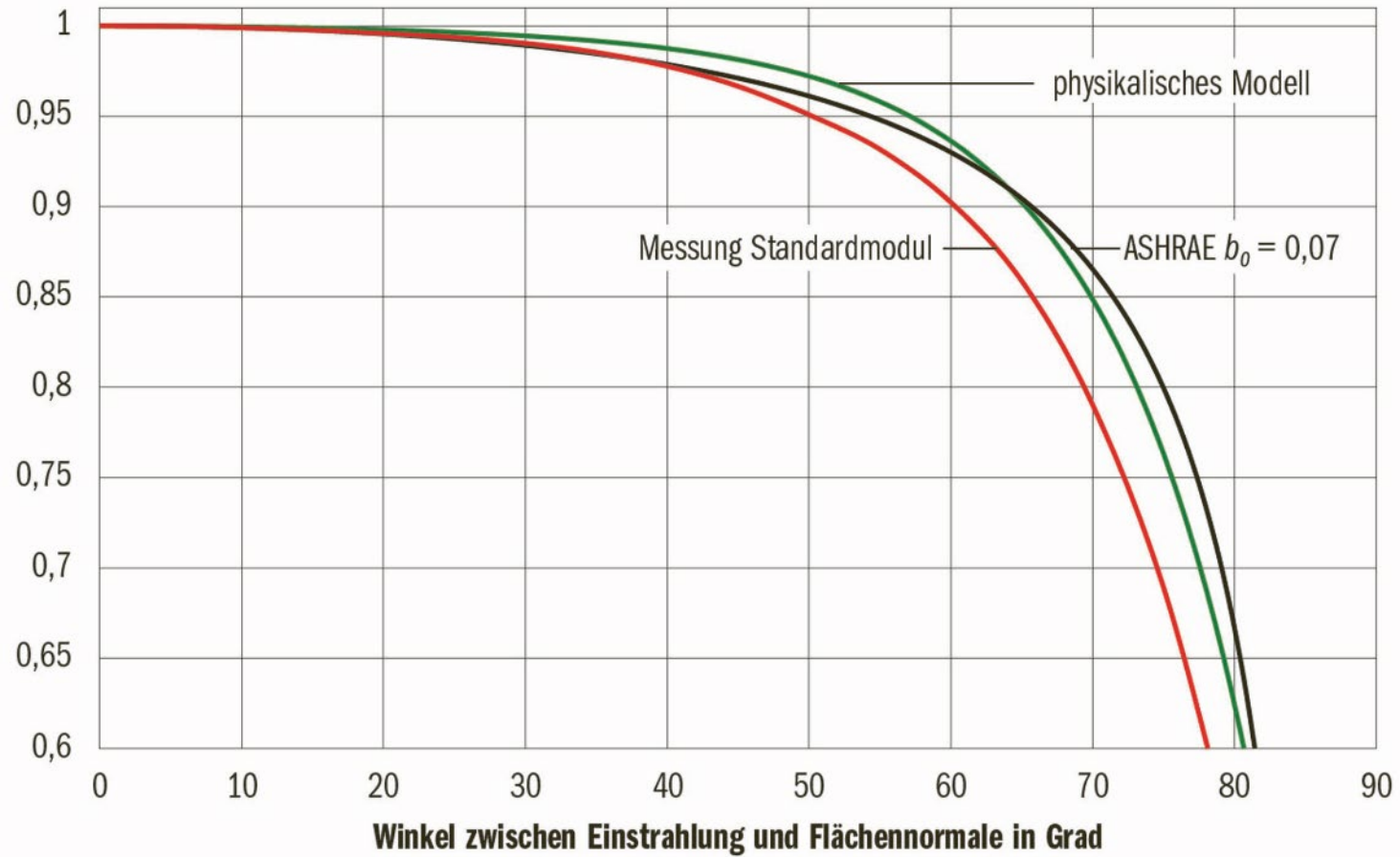

Quelle: Christof Bucher, Photovoltaikanlagen, Faktor Verlag 2021

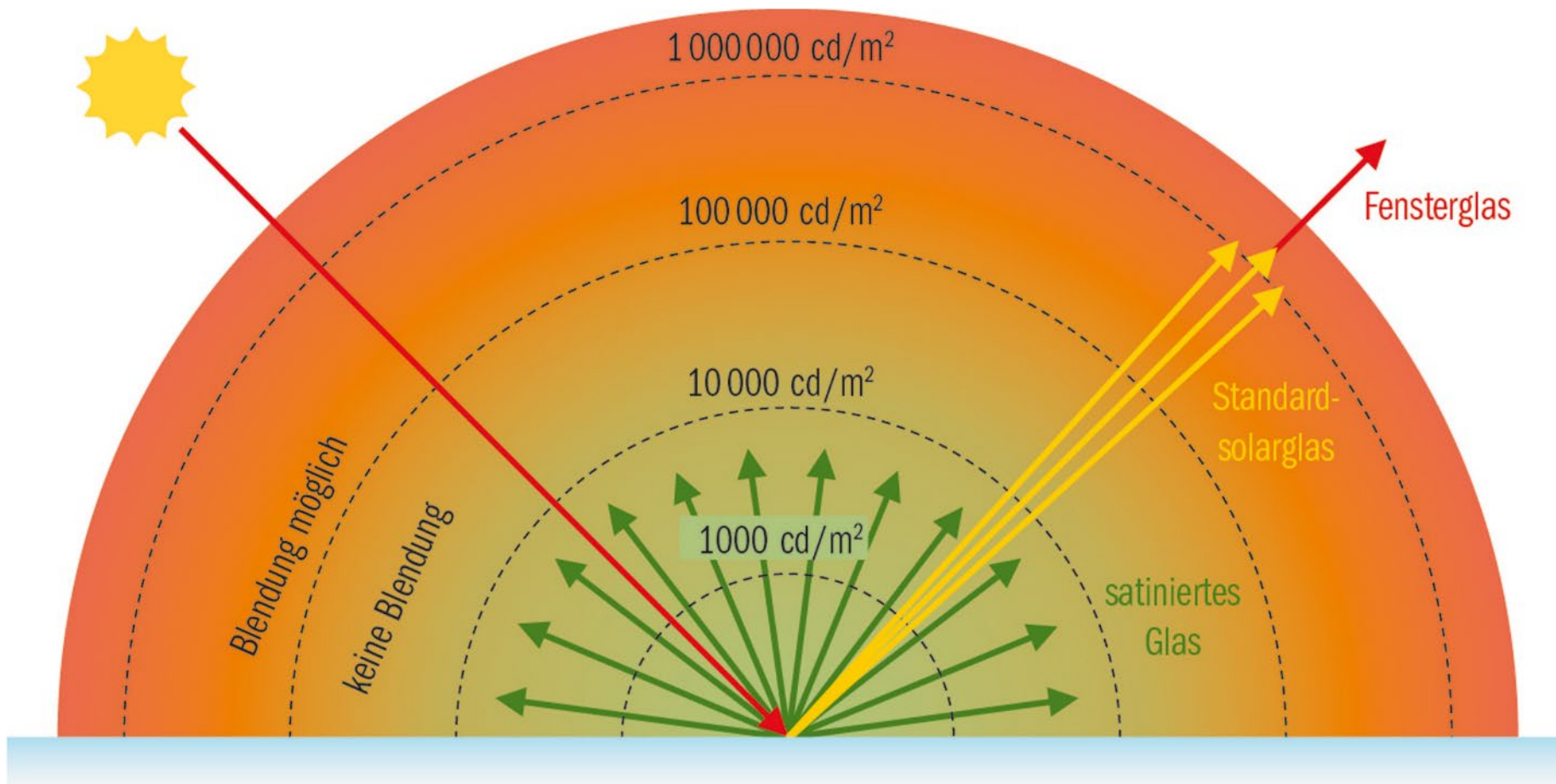

Quelle: Christof Bucher, Photovoltaikanlagen, Faktor Verlag 2021

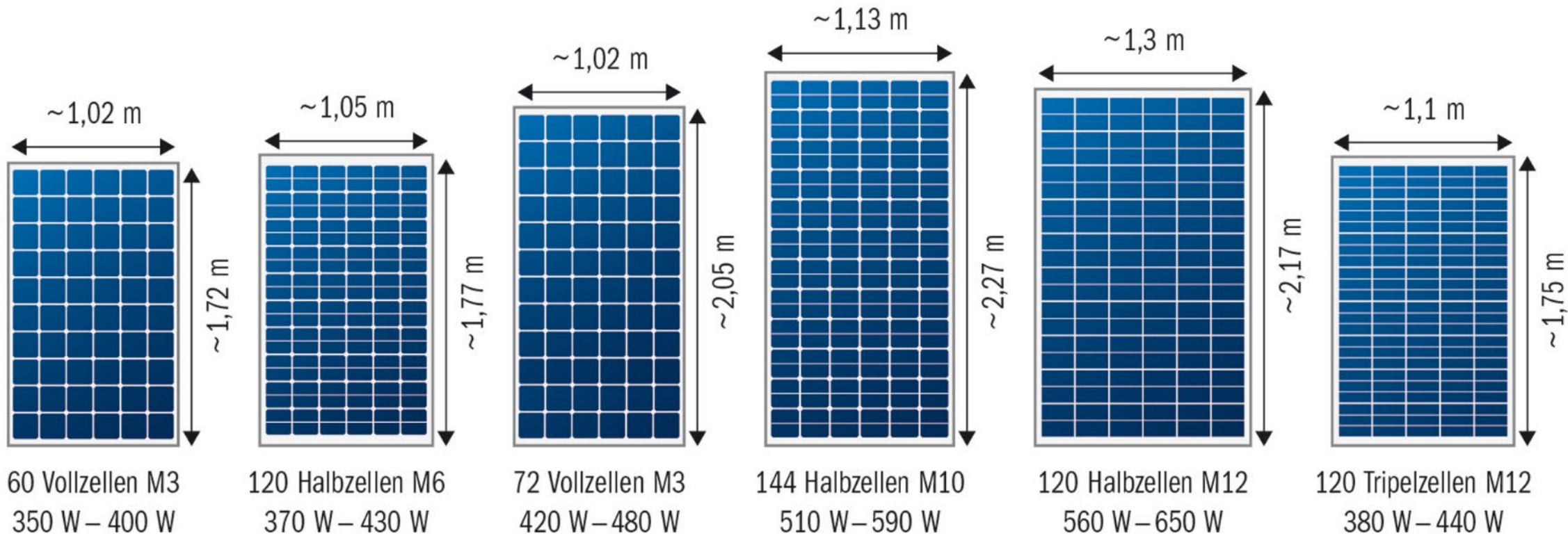

Quelle: Christof Bucher, Photovoltaikanlagen, Faktor Verlag 2021

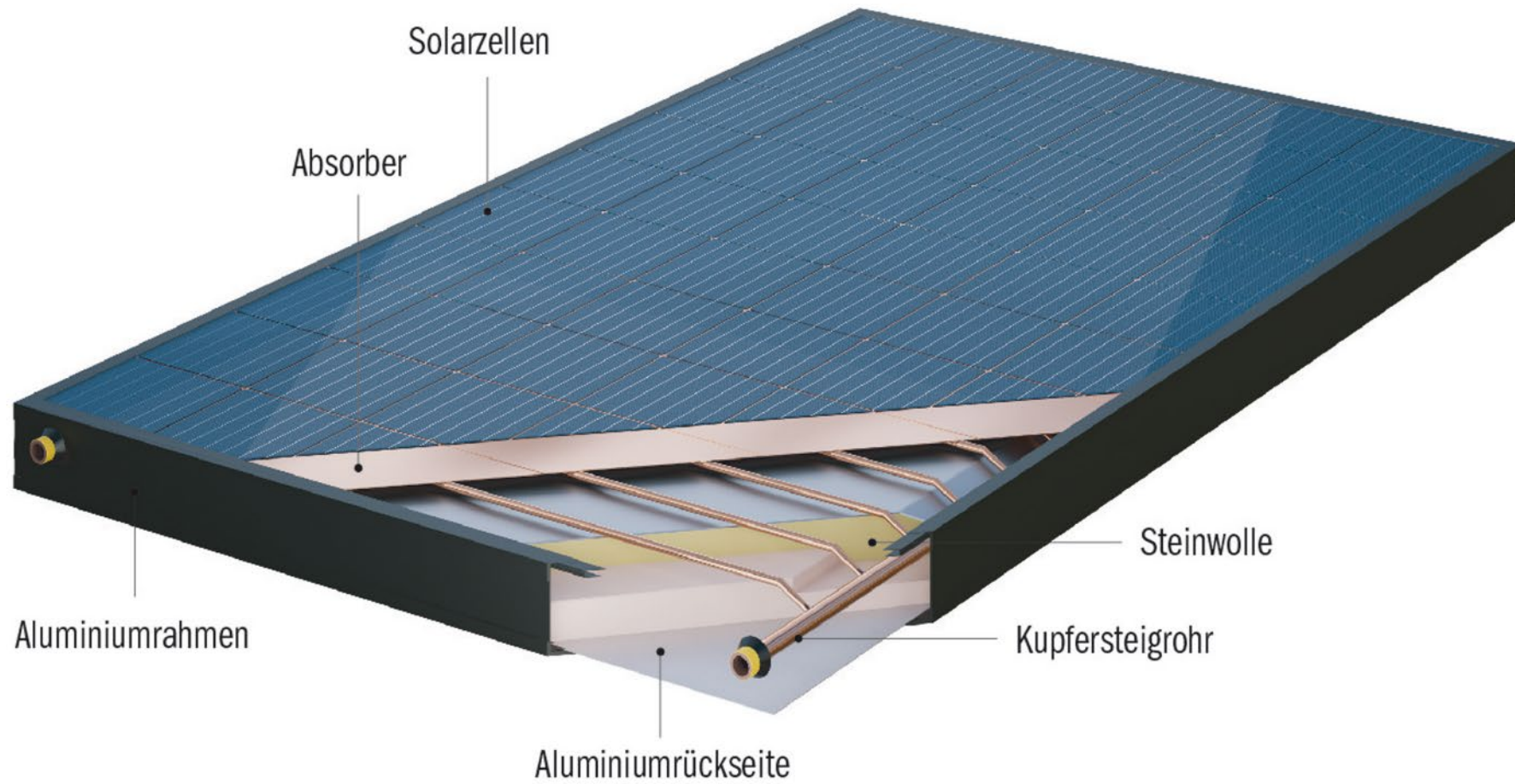

Quelle: Christof Bucher, Photovoltaikanlagen, Faktor Verlag 2021

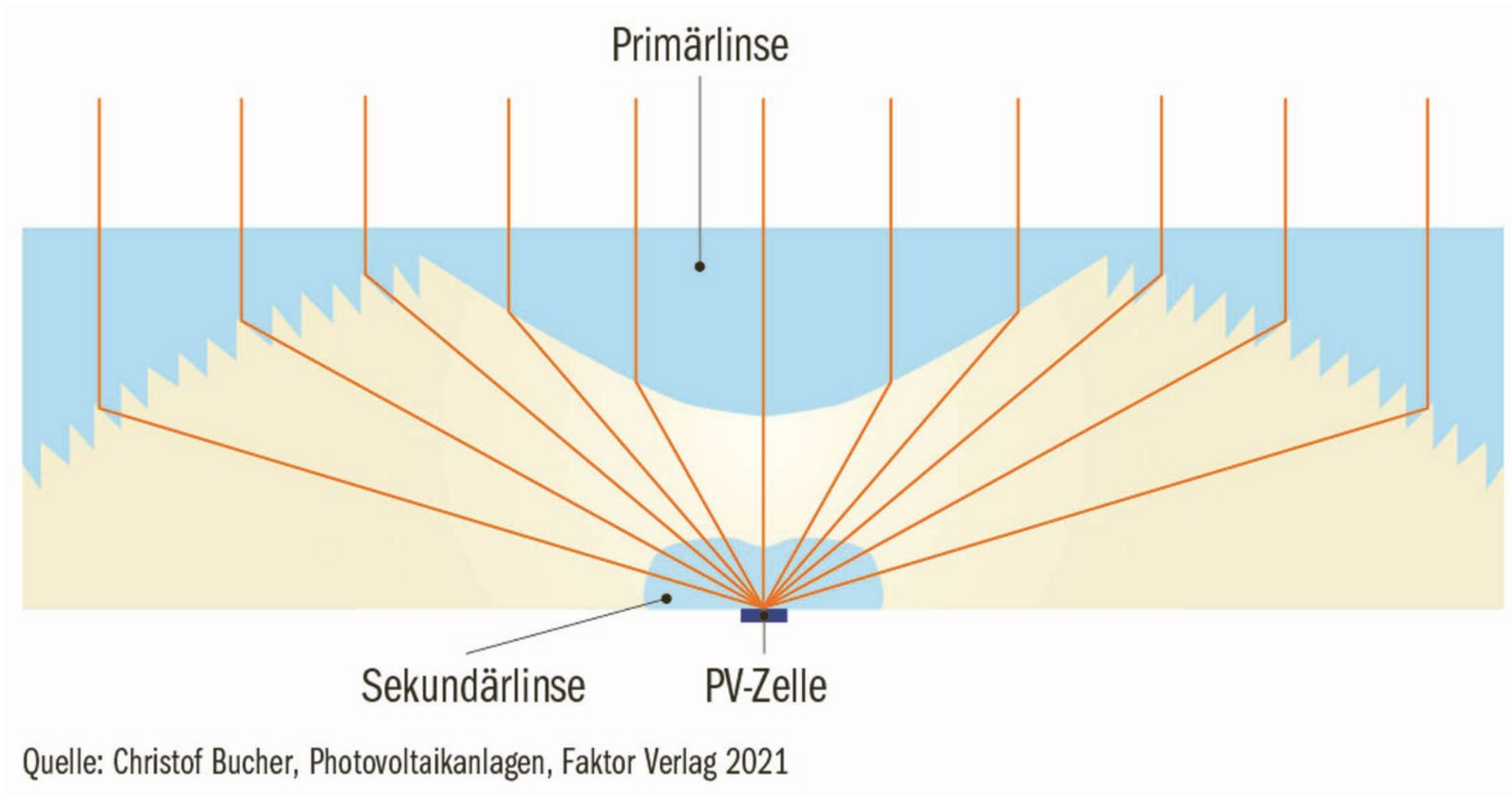

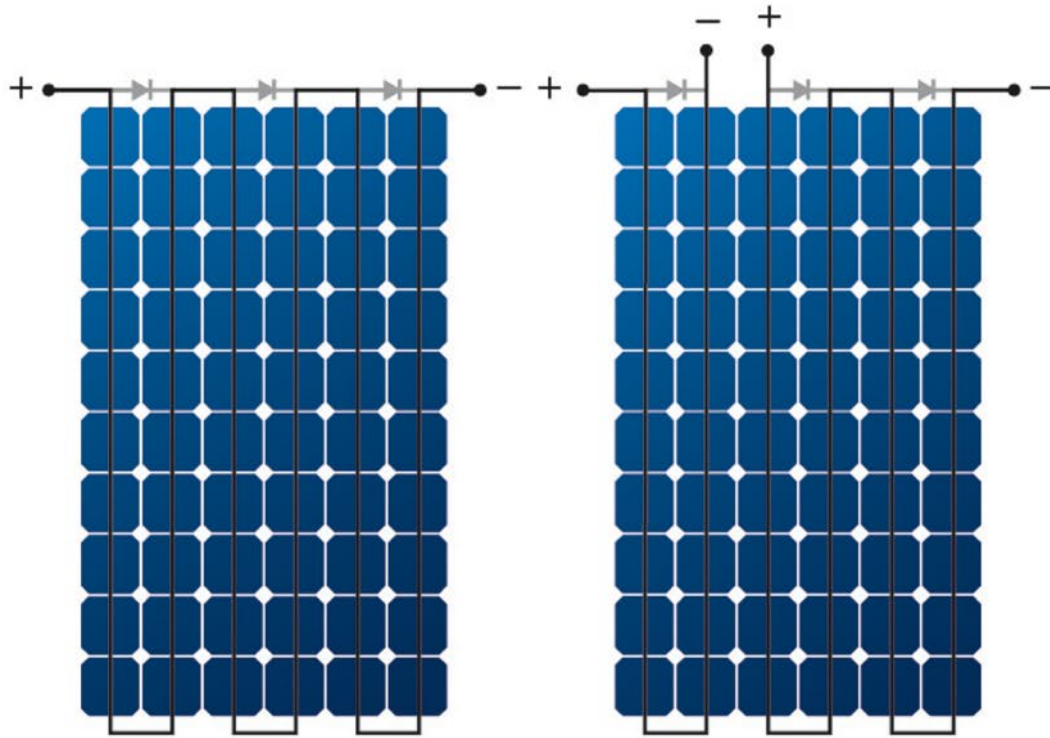

60-Zellen-Standardmodul mit
schlangenförmiger Serienschaltung

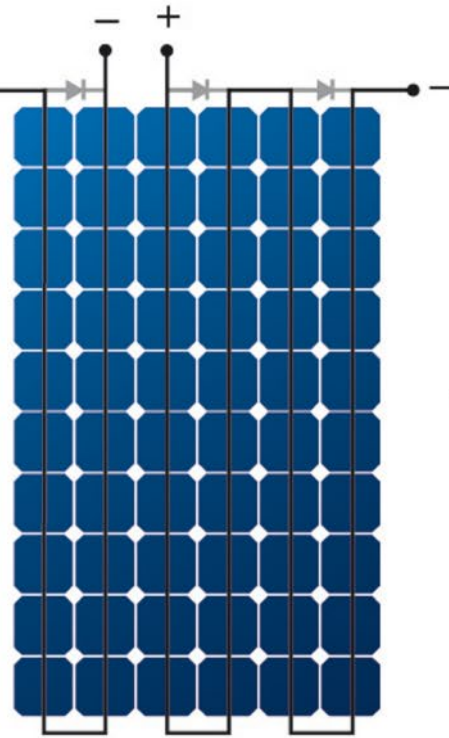

Projektspezifisches
Sondermodul

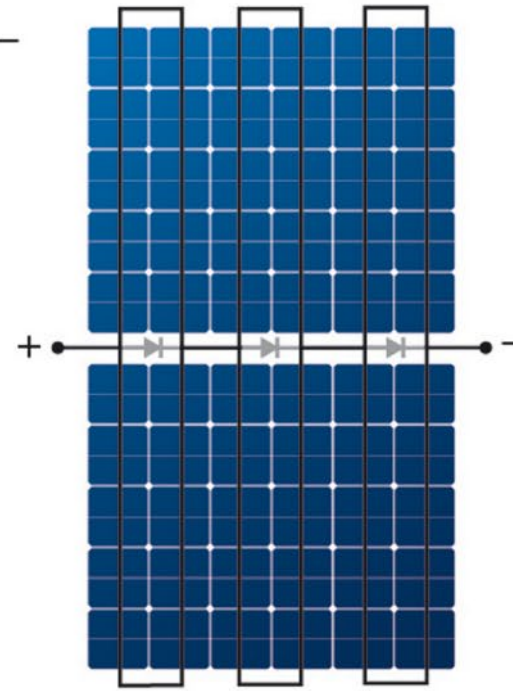

Halbzellenmodul mit Modul-
anschlussdose in der Modulmitte

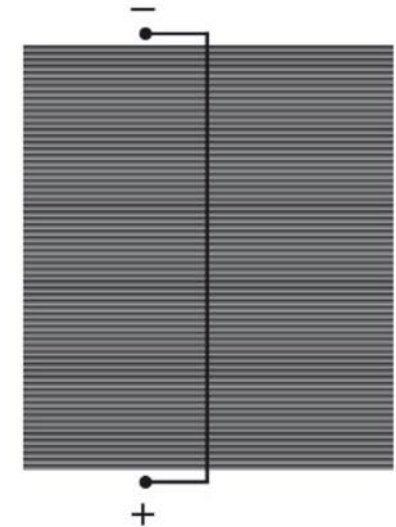

Dünnschichtmodul

Quelle: Christof Bucher, Photovoltaikanlagen, Faktor Verlag 2021

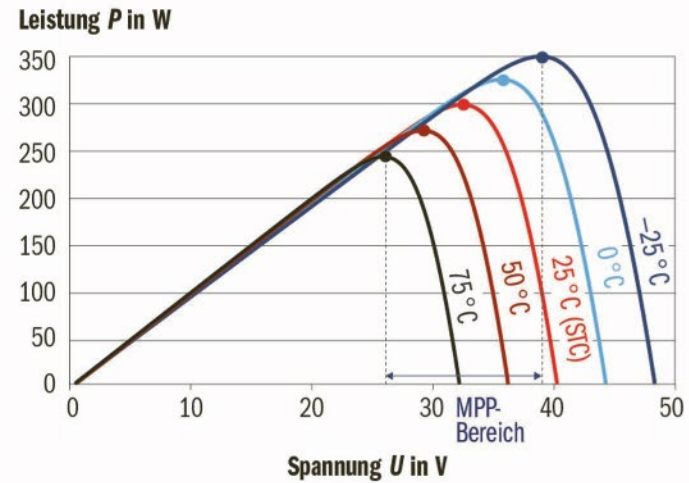
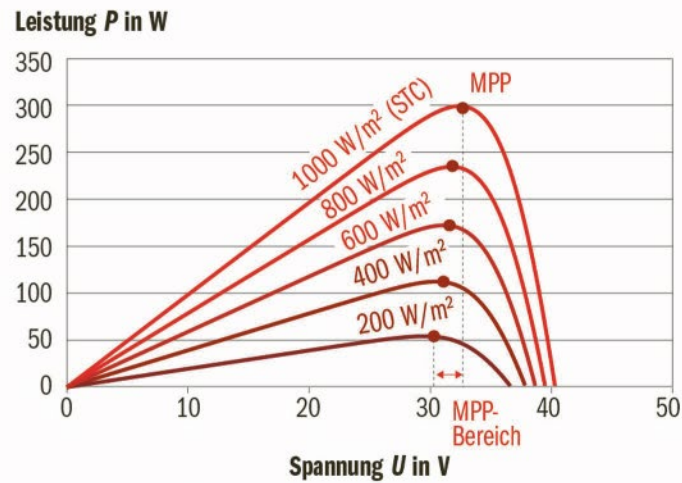
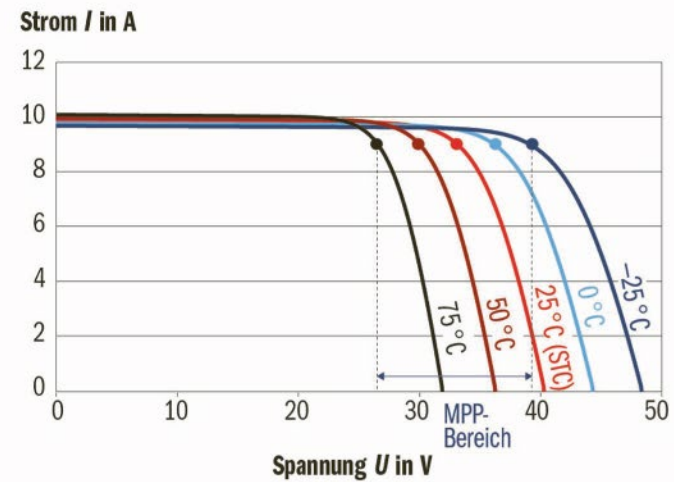
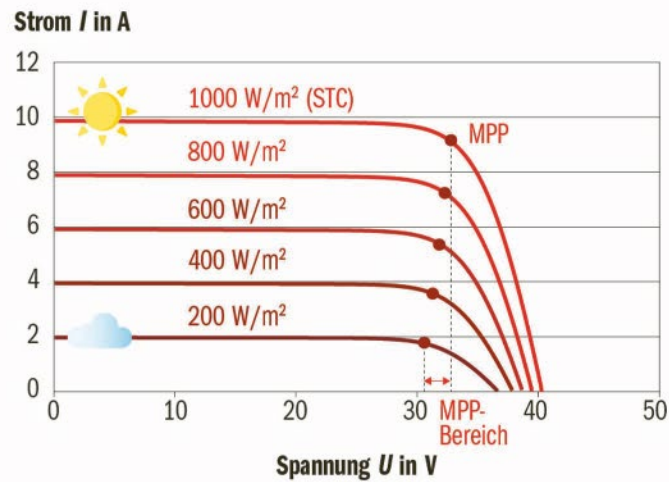

Quelle: Christof Bucher, Photovoltaikanlagen, Faktor Verlag 2021

Strom I in A

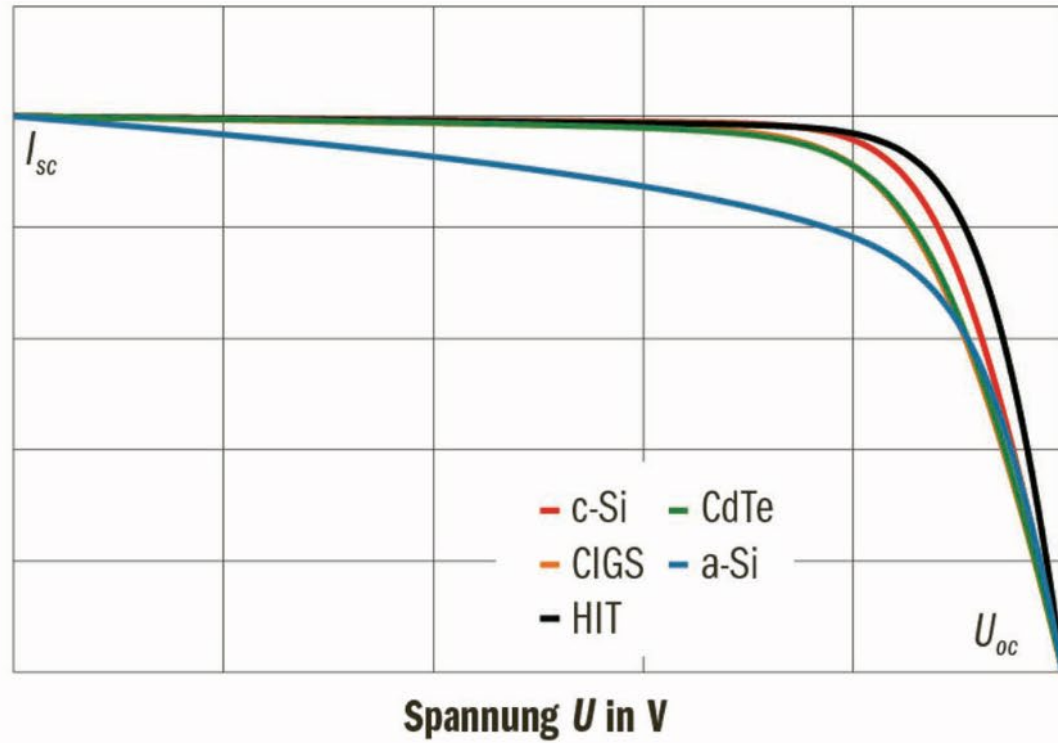

Leistung P in W

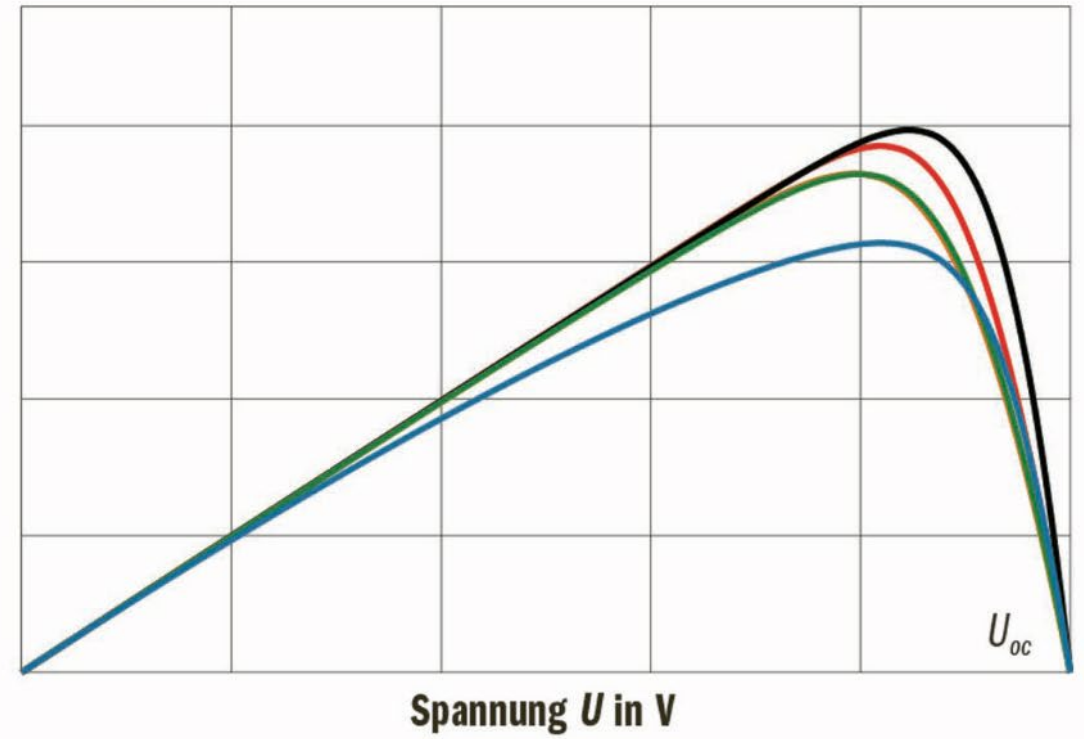

Quelle: Christof Bucher, Photovoltaikanlagen, Faktor Verlag 2021

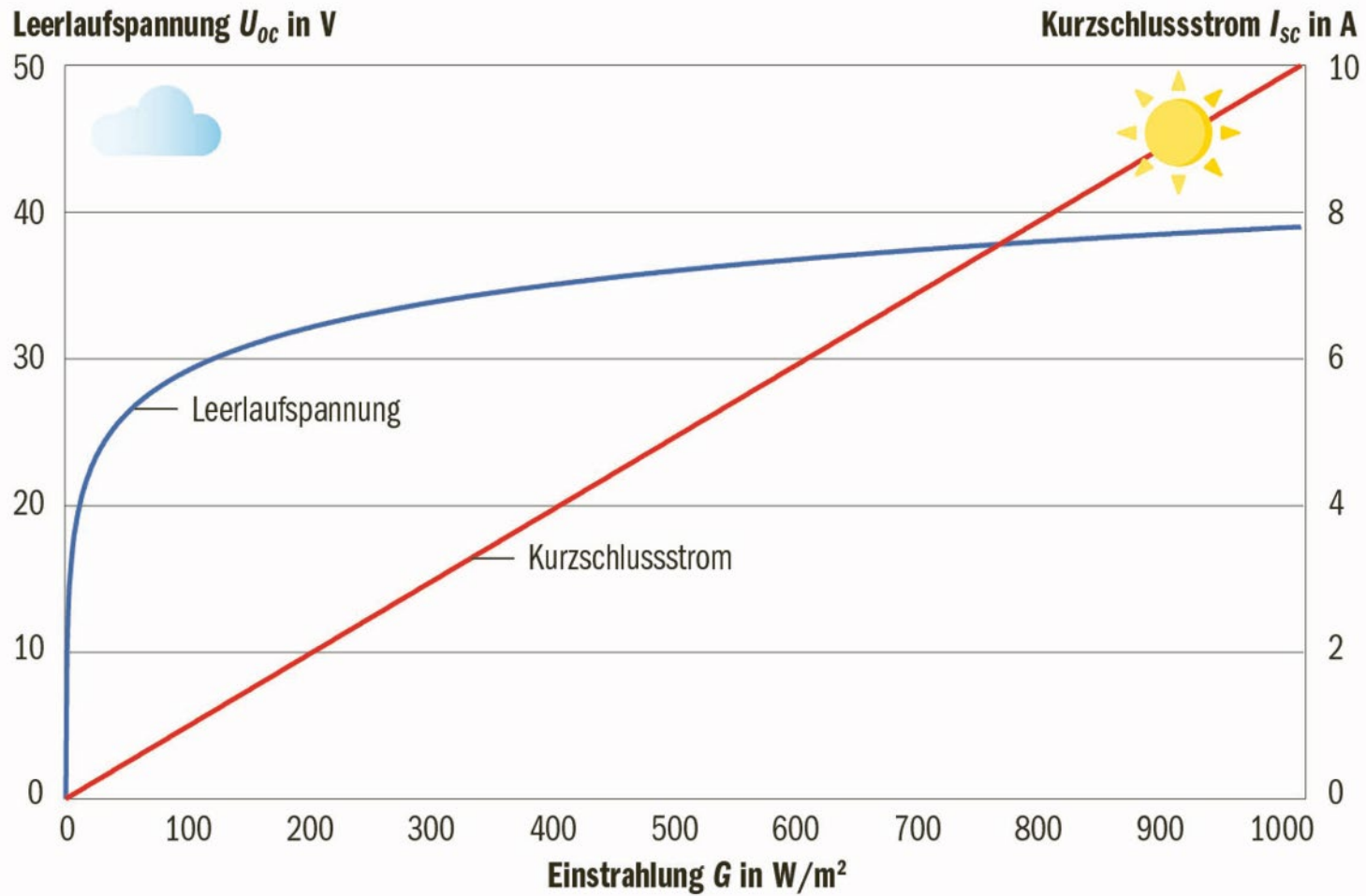

Quelle: Christof Bucher, Photovoltaikanlagen, Faktor Verlag 2021

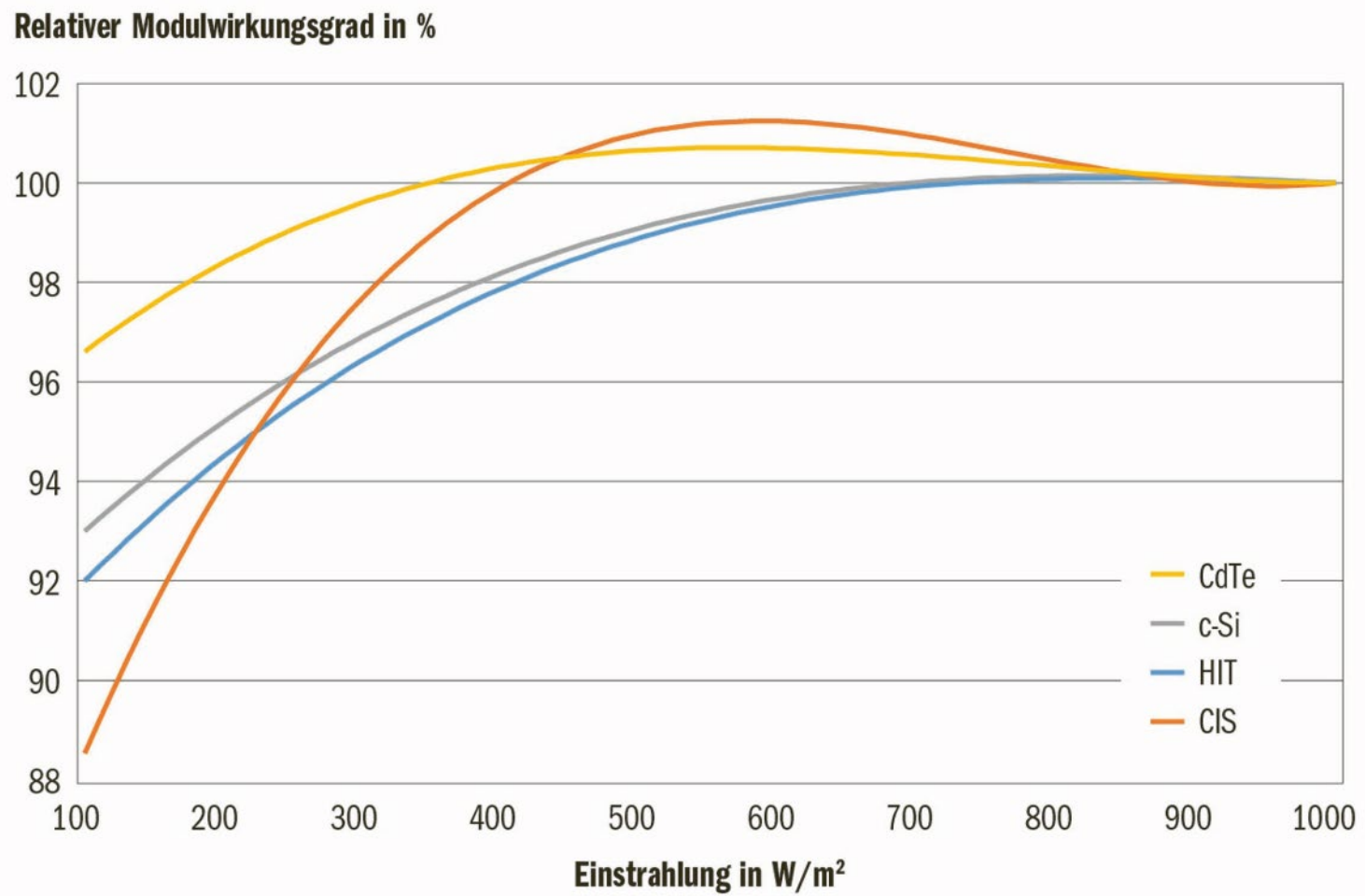

Quelle: Christof Bucher, Photovoltaikanlagen, Faktor Verlag 2021

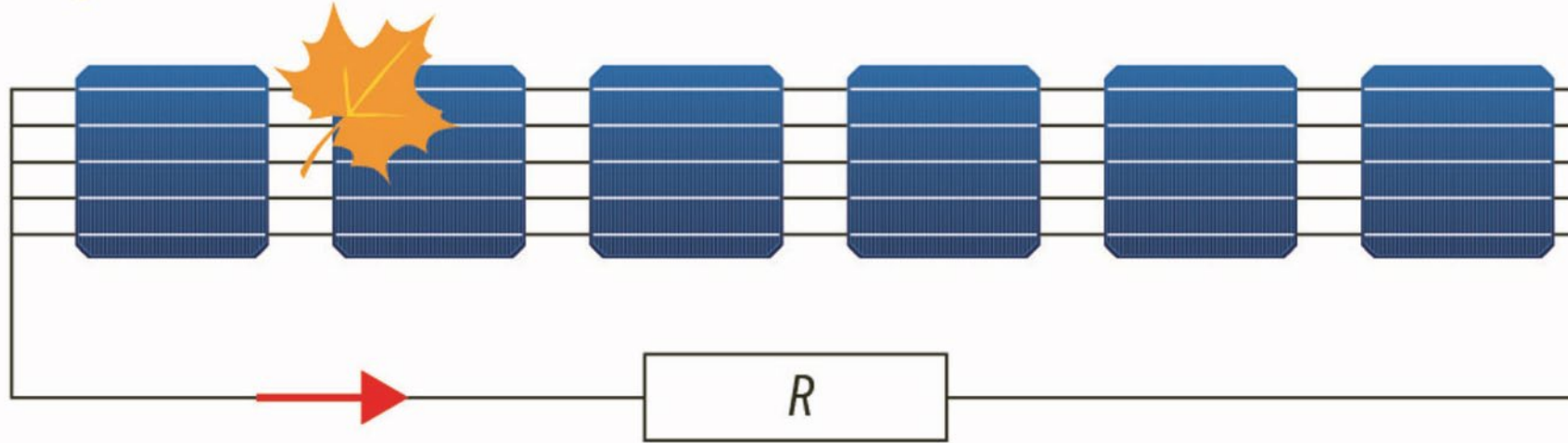

Quelle: Christof Bucher, Photovoltaikanlagen, Faktor Verlag 2021

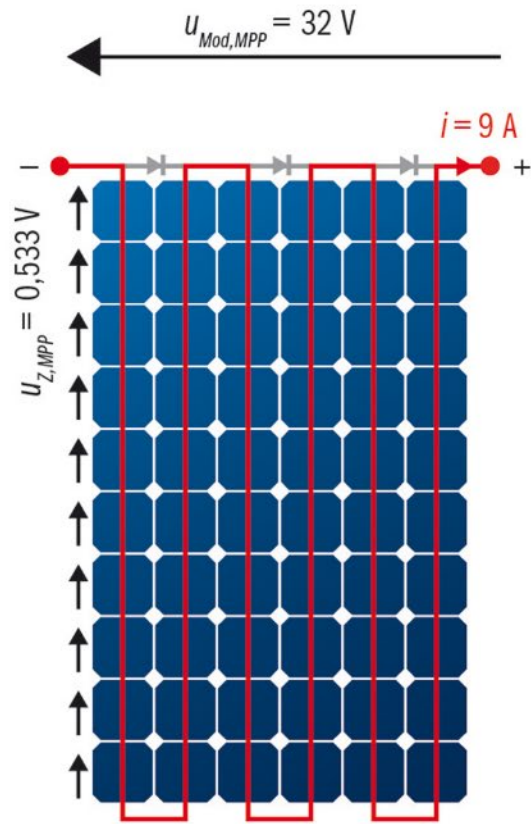

Unverschattet
 $P = 288 \text{ W}$

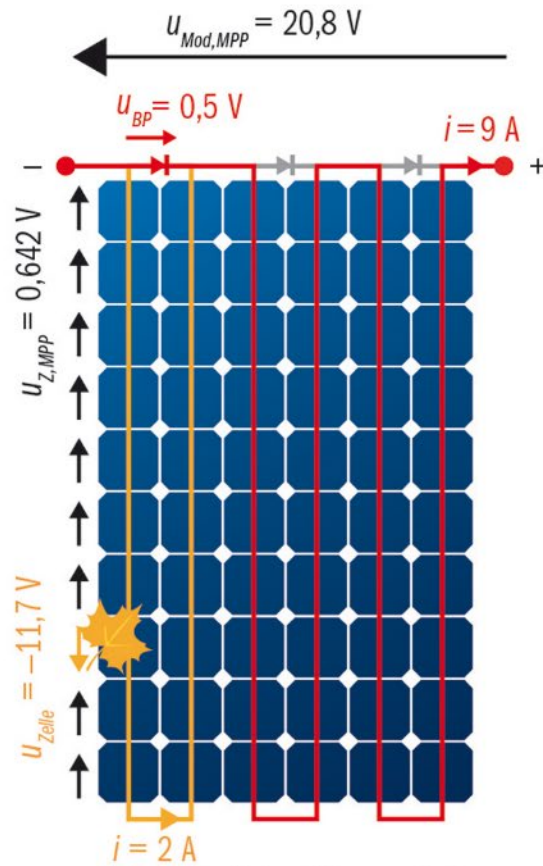

Teilverschattet mit Bypassdiode
 $P = 185 \text{ W}$

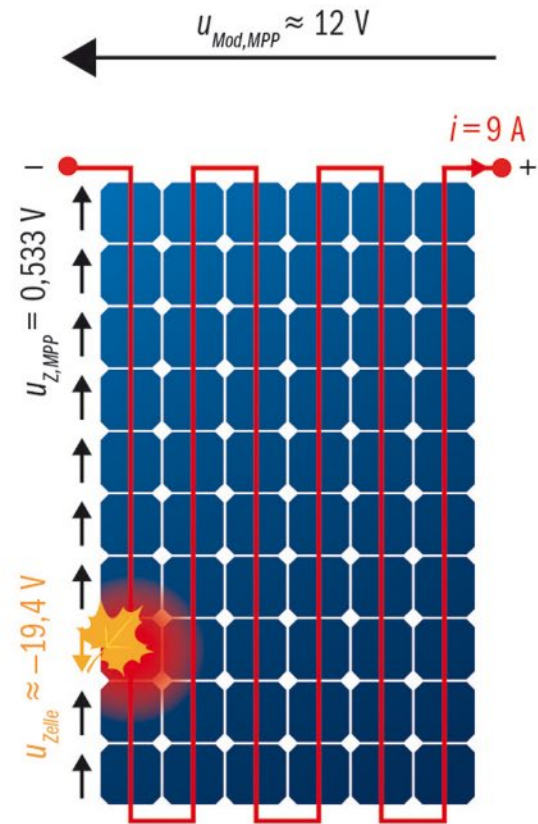

Teilverschattet ohne Bypassdiode
 $P = 108 \text{ W}$ (Hotspot-Gefahr!)

Quelle: Christof Bucher, Photovoltaikanlagen, Faktor Verlag 2021

Strom I in A

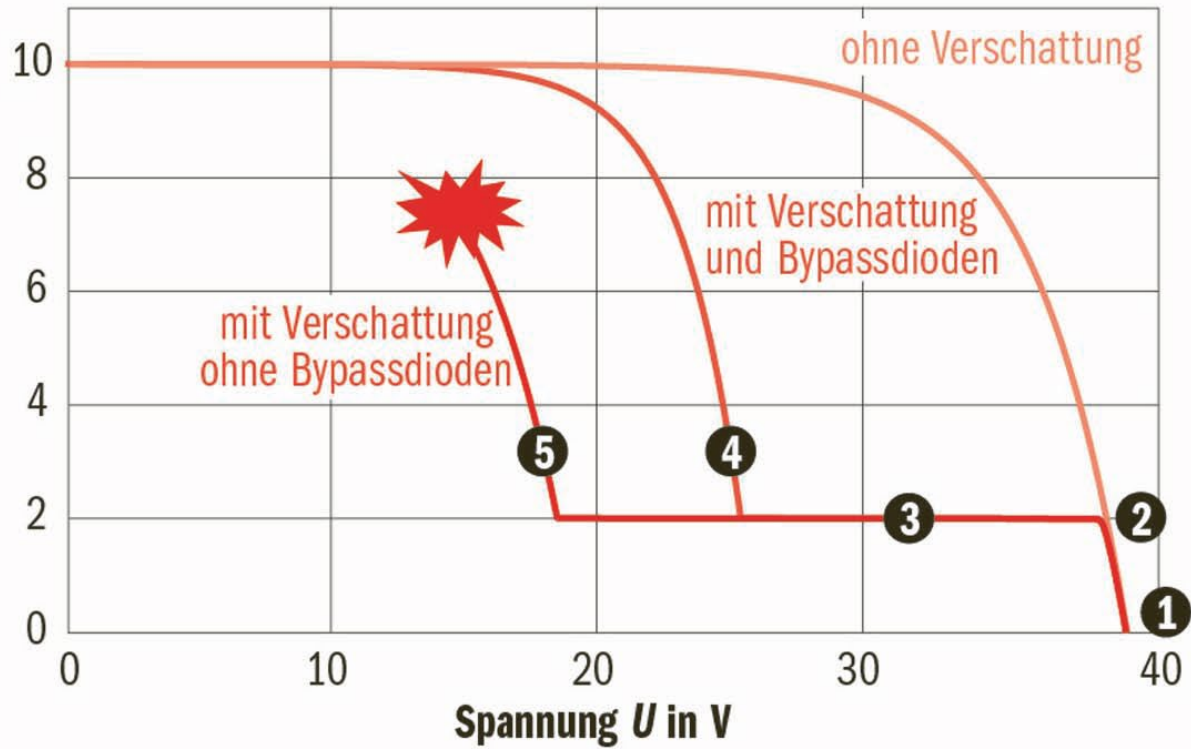

Leistung P in W

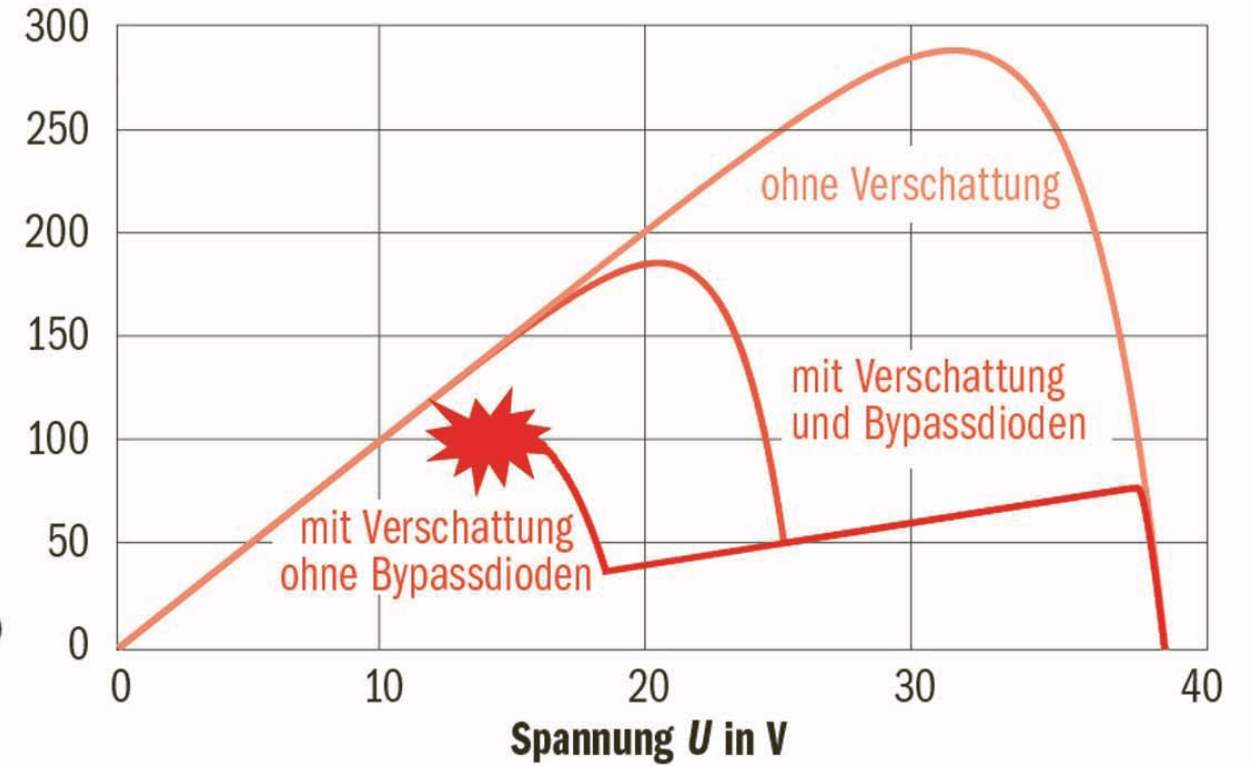

Quelle: Christof Bucher, Photovoltaikanlagen, Faktor Verlag 2021

Strom I in A

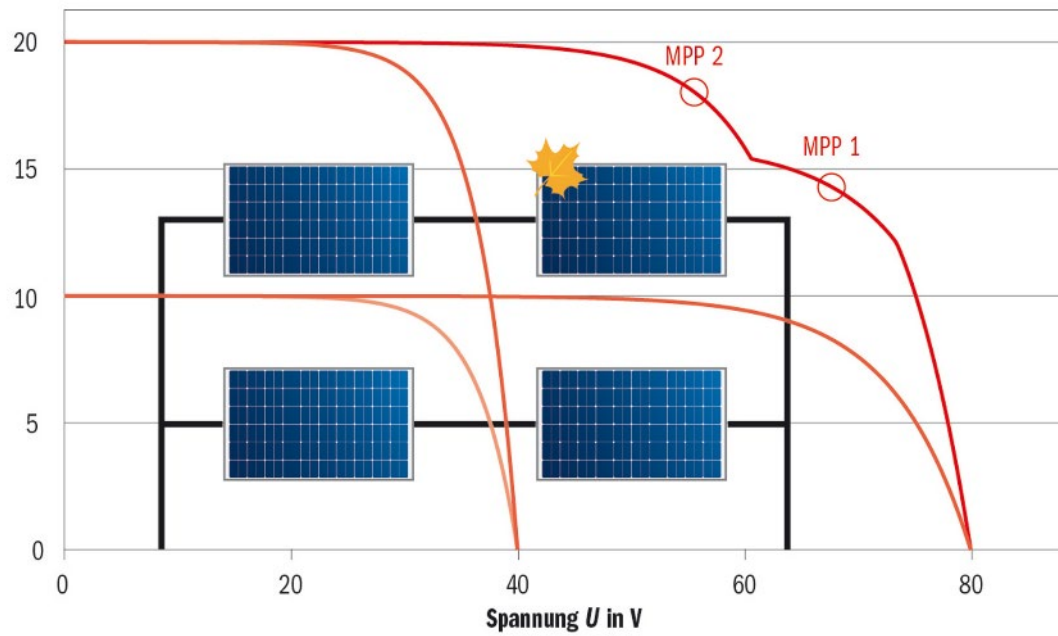

Leistung P in W

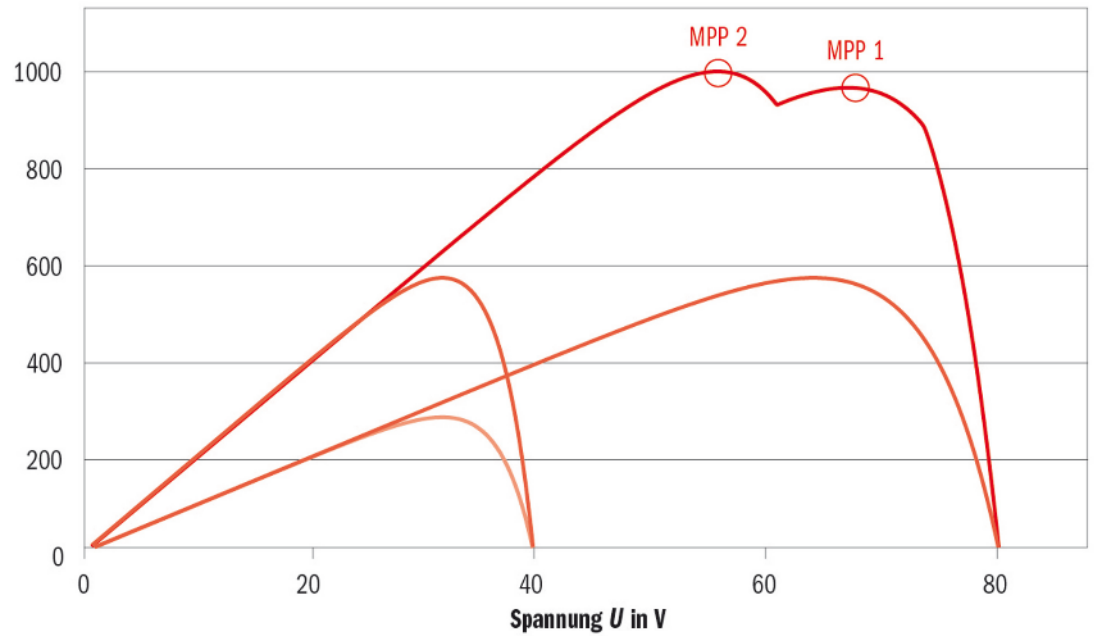

Quelle: Christof Bucher, Photovoltaikanlagen, Faktor Verlag 2021

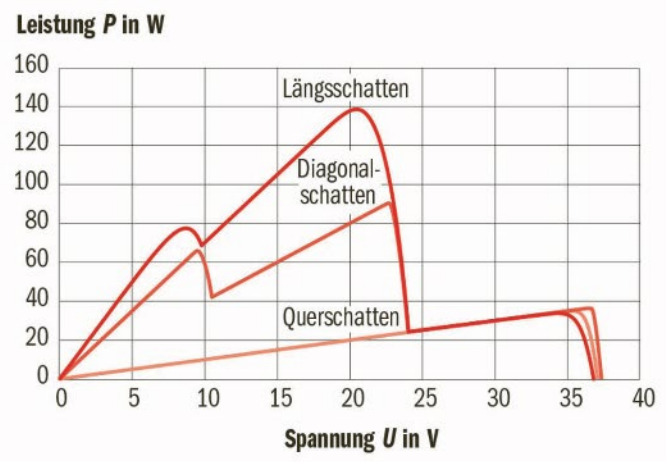
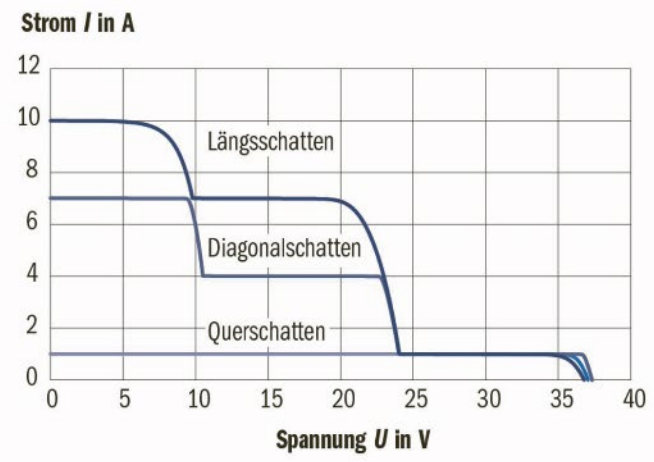
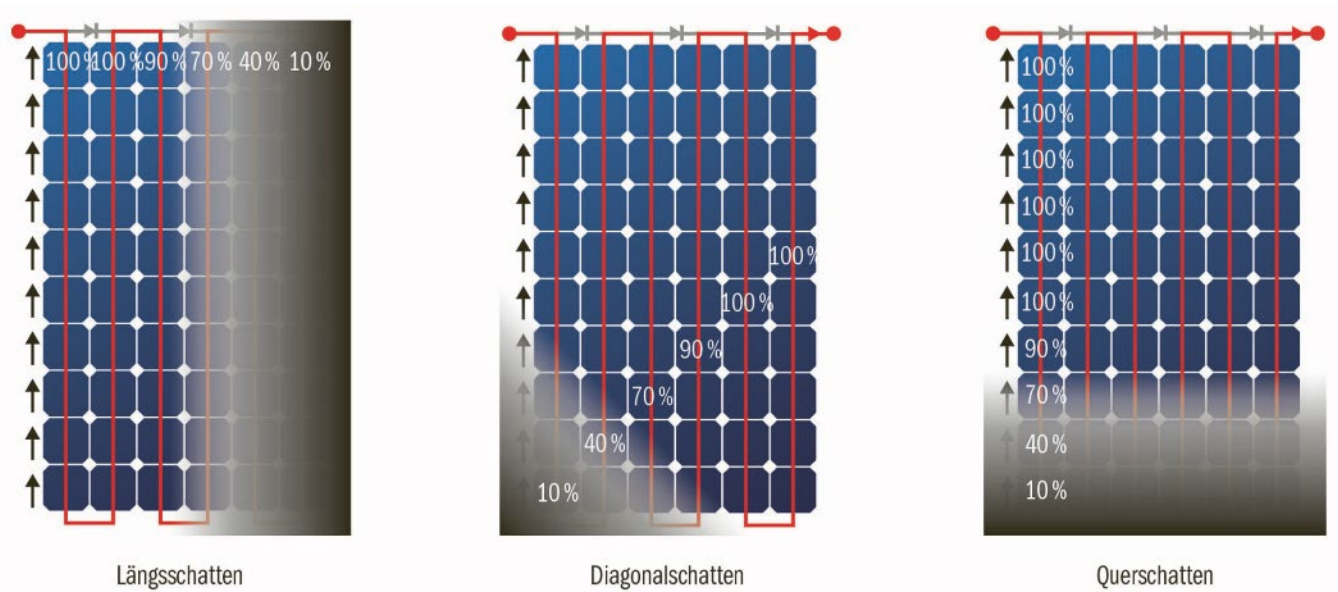

Quelle: Christof Bucher, Photovoltaikanlagen, Faktor Verlag 2021

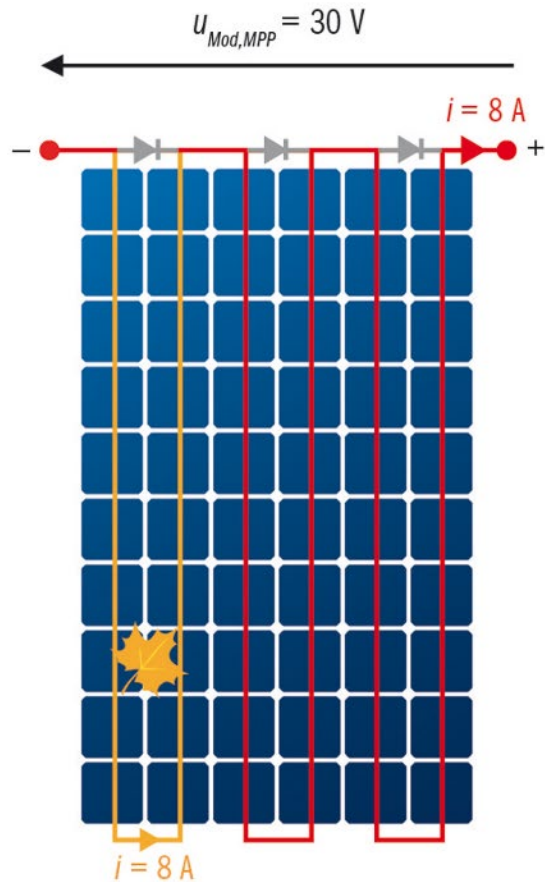

Leicht teilverschattet
 $P = 240 \text{ W}$

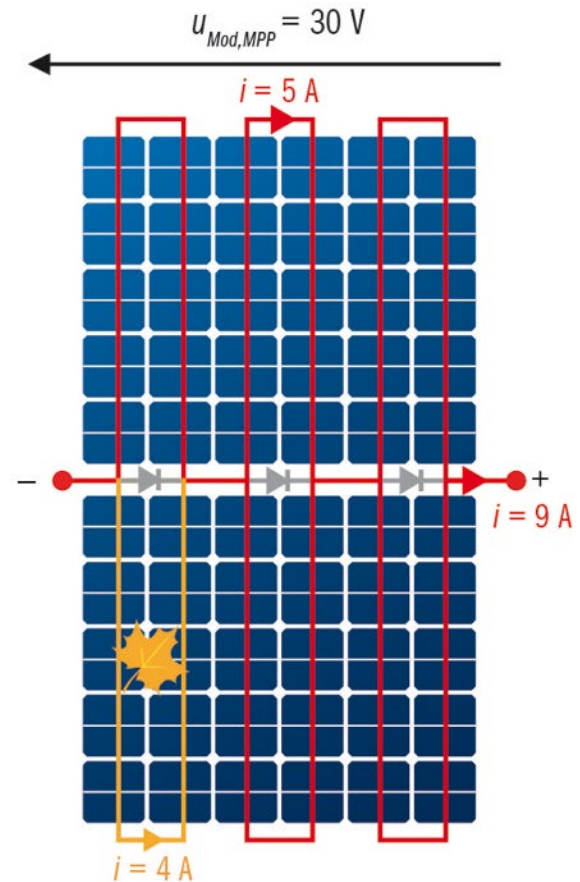

Leicht teilverschattet, Halbzellenmodul
 $P = 270 \text{ W}$

Quelle: Christof Bucher, Photovoltaikanlagen, Faktor Verlag 2021

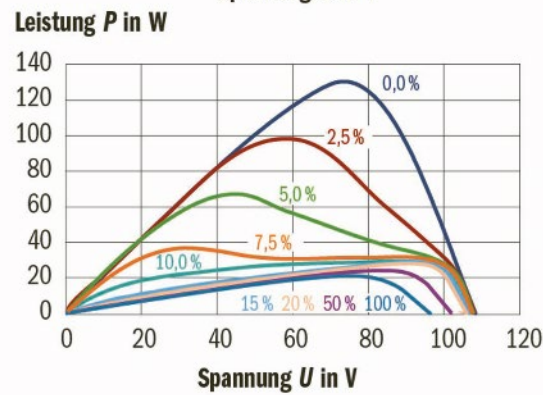
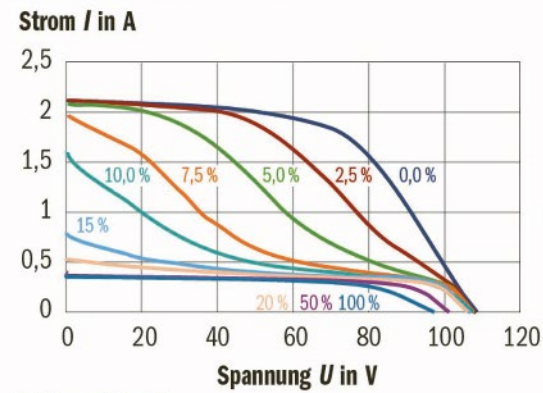
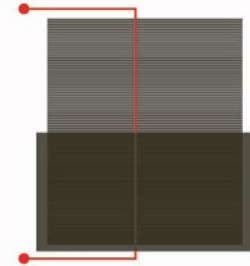
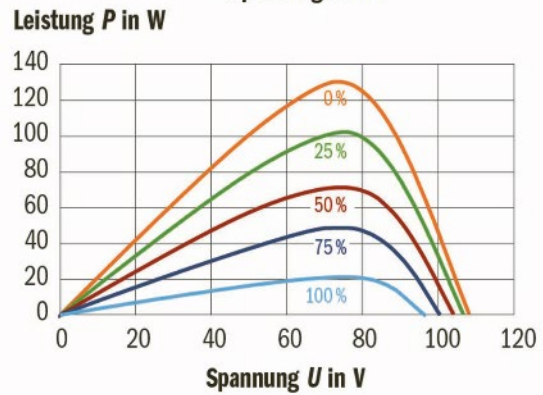
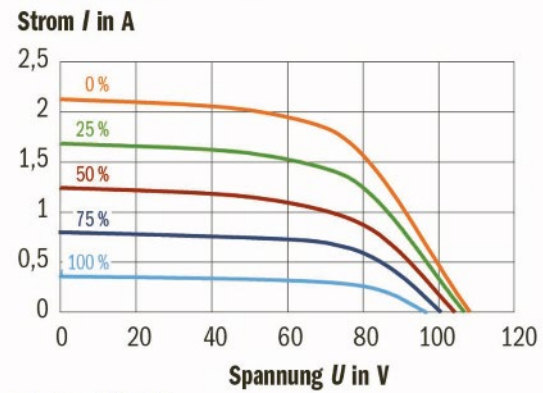
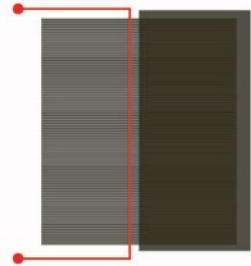

Quelle: Christof Bucher, Photovoltaikanlagen, Faktor Verlag 2021

Garantierte Mindestleistung in %

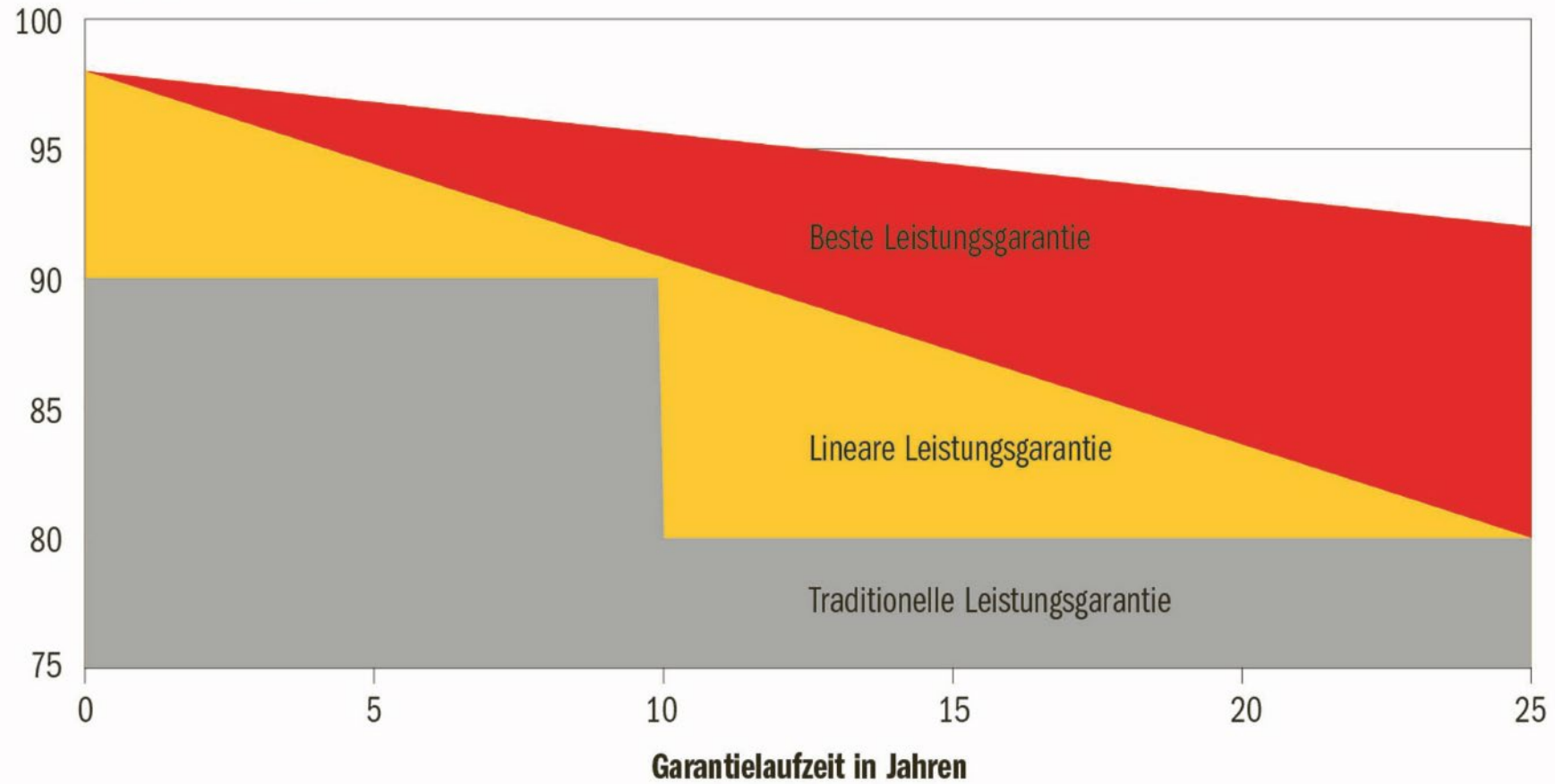

Quelle: Christof Bucher, Photovoltaikanlagen, Faktor Verlag 2021

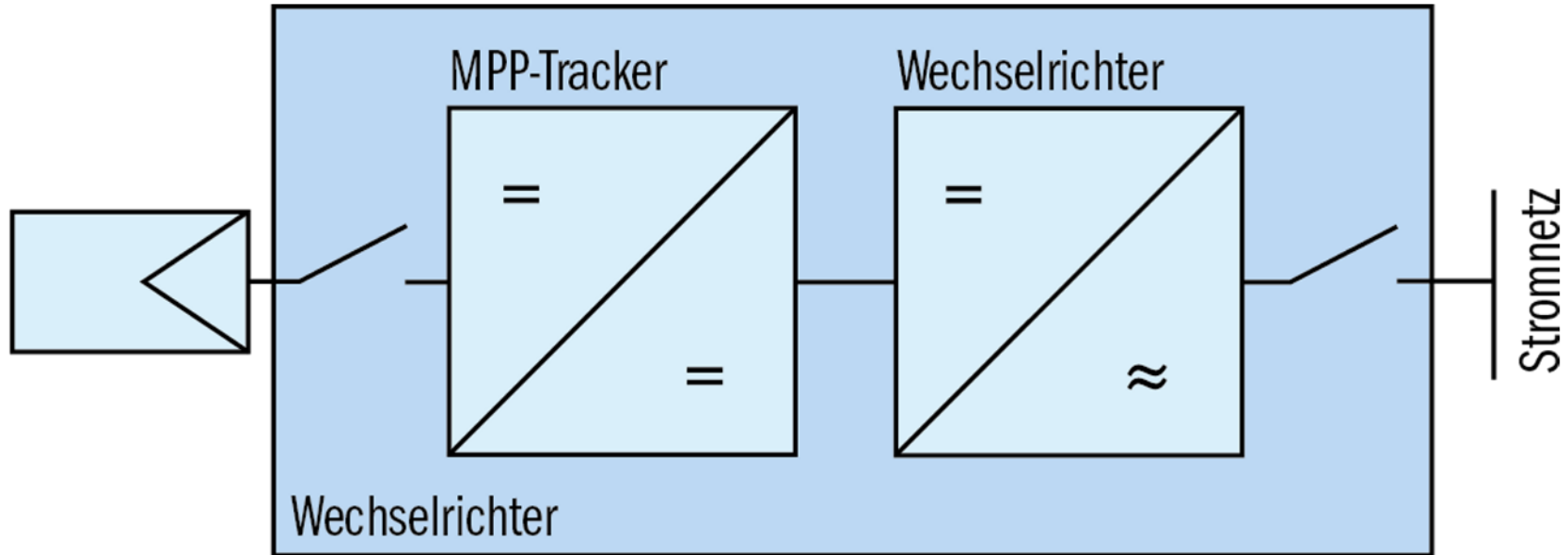

Quelle: Christof Bucher, Photovoltaikanlagen, Faktor Verlag 2021

Leistung P in W

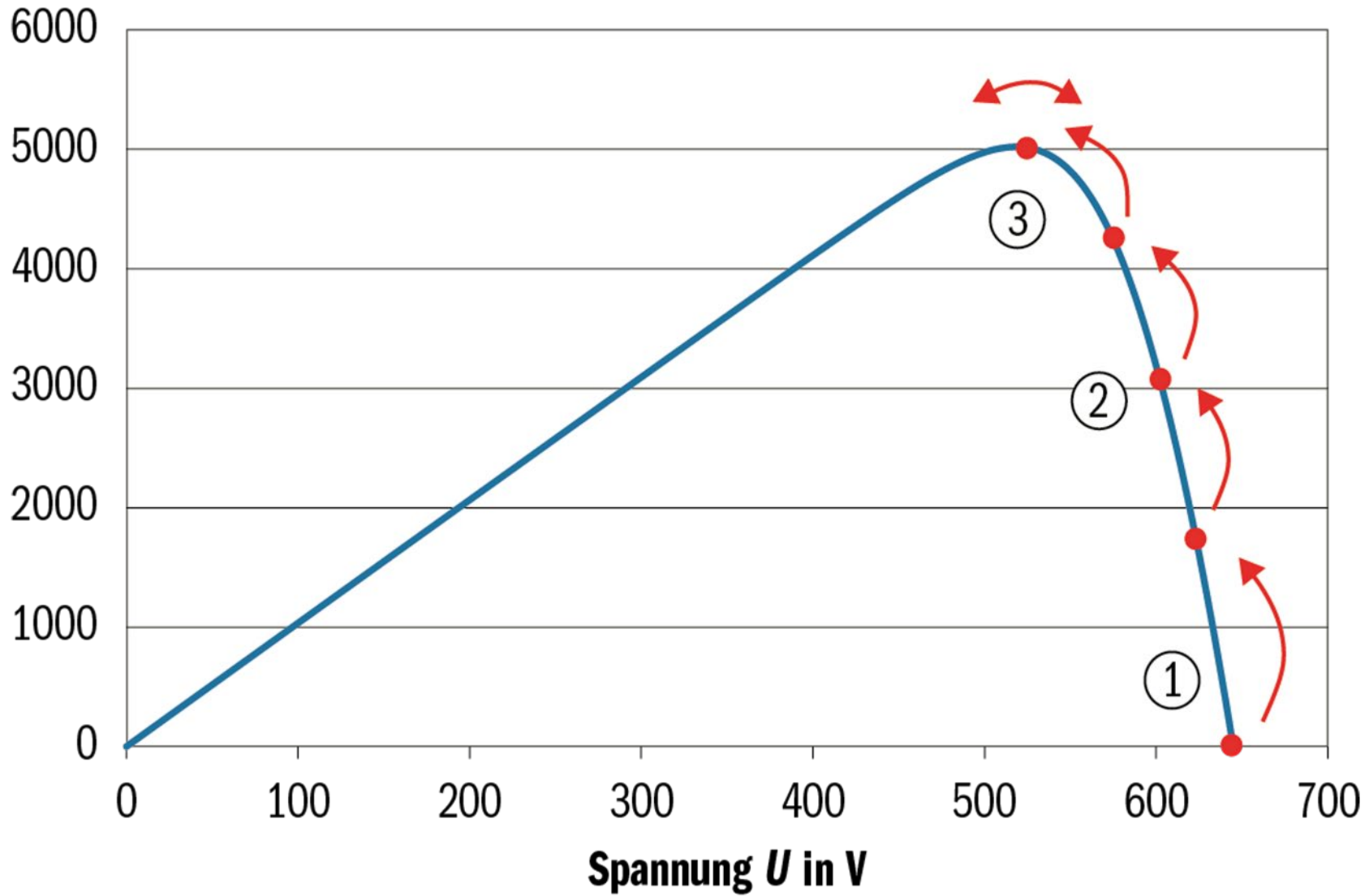

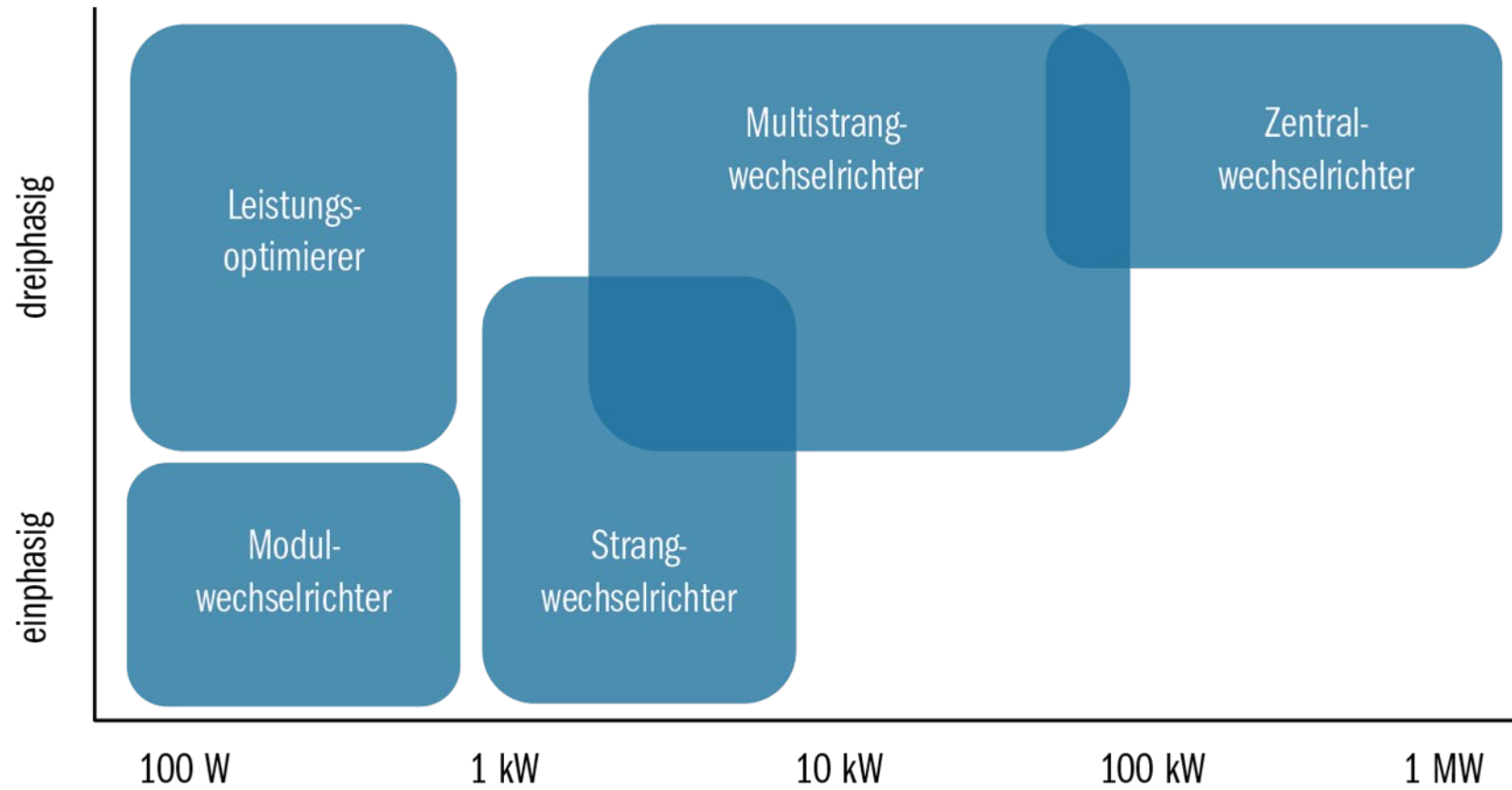

Quelle: Christof Bucher, Photovoltaikanlagen, Faktor Verlag 2021

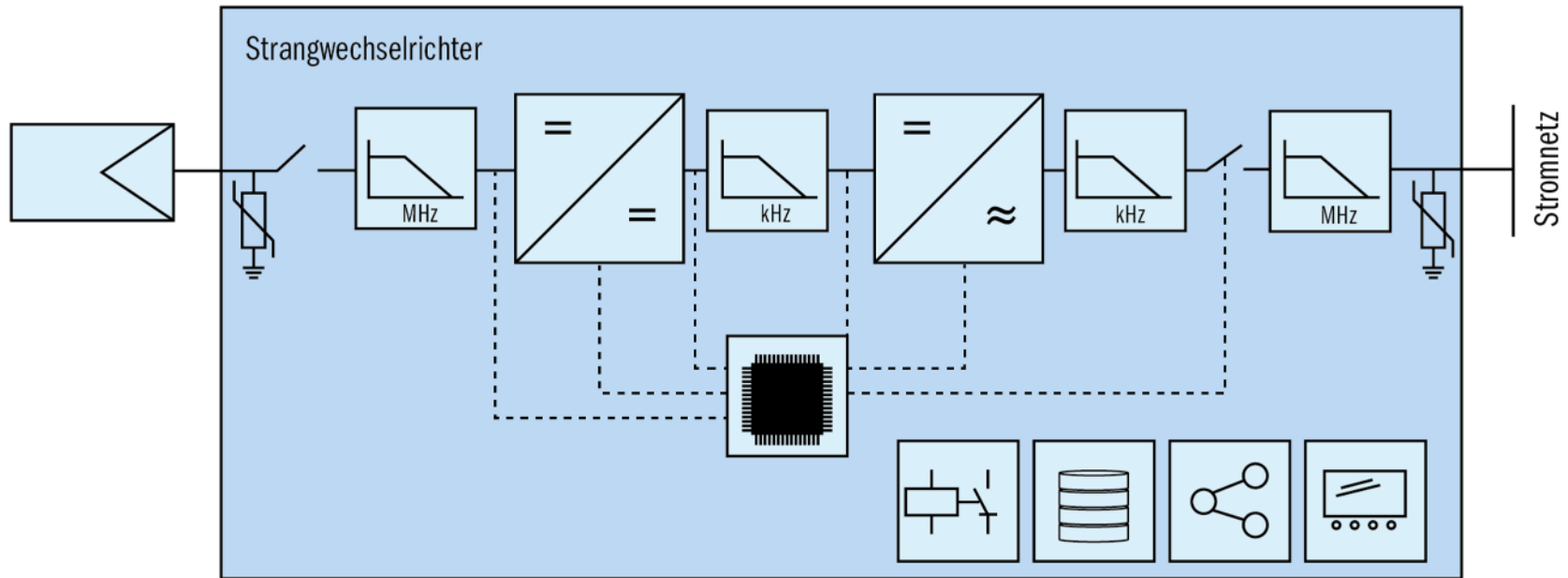

Quelle: Christof Bucher, Photovoltaikanlagen, Faktor Verlag 2021

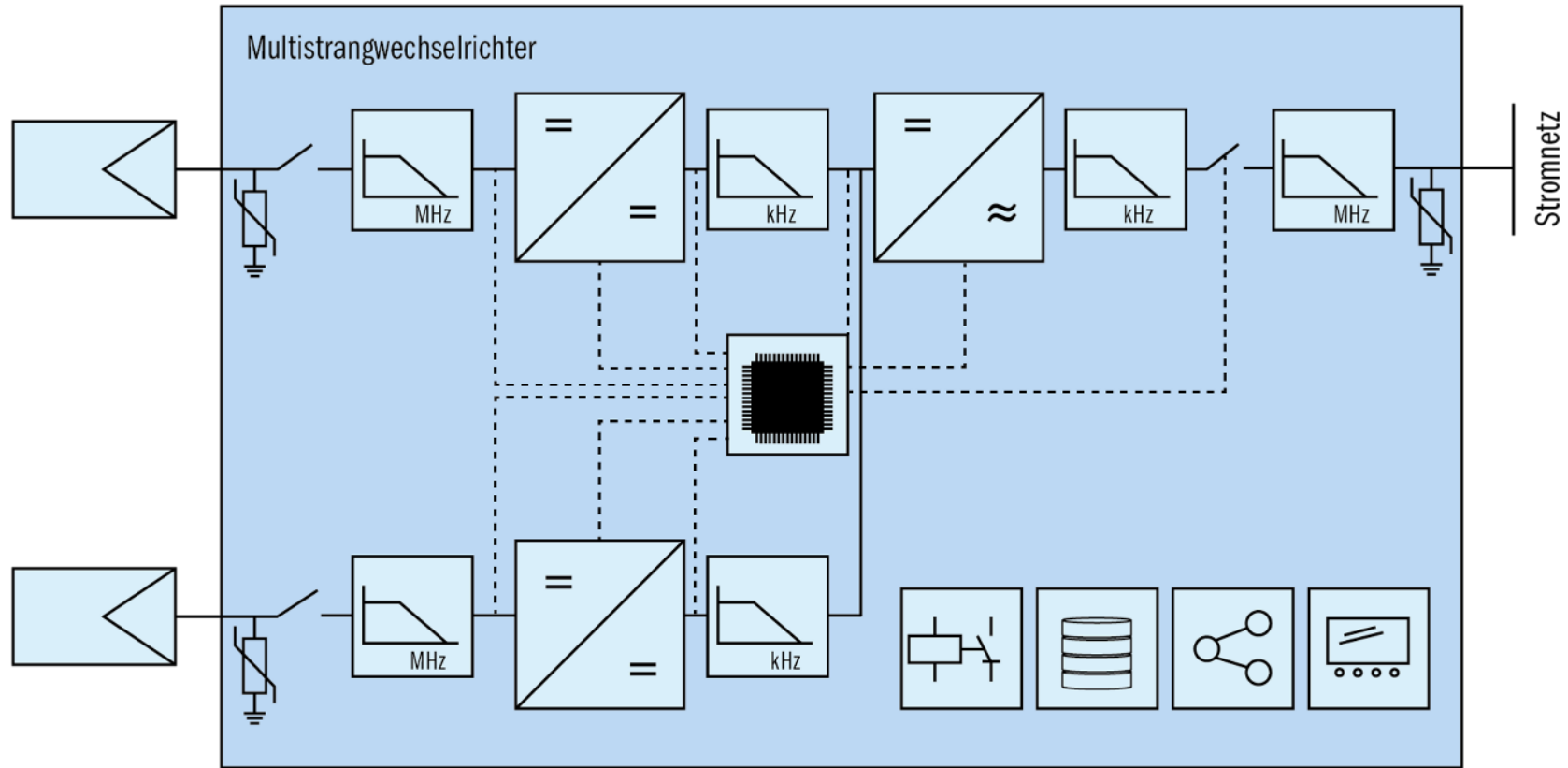

Quelle: Christof Bucher, Photovoltaikanlagen, Faktor Verlag 2021

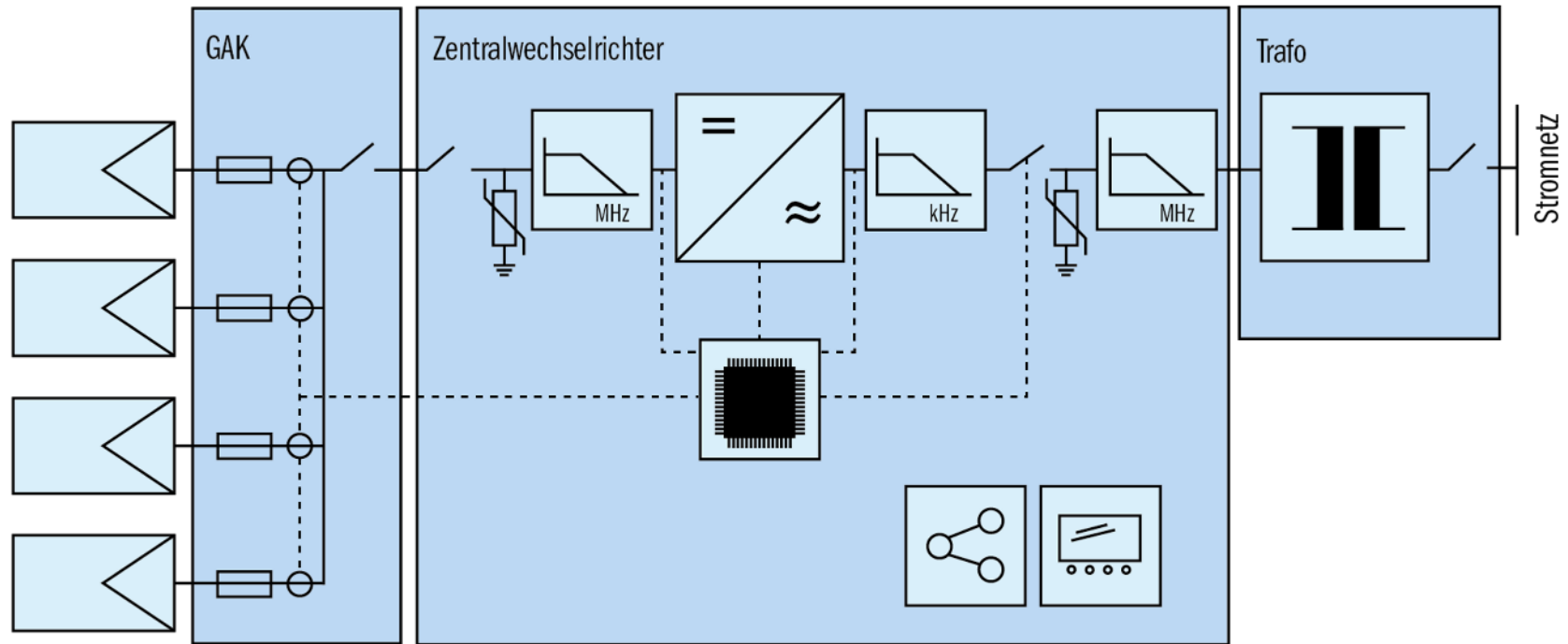

Quelle: Christof Bucher, Photovoltaikanlagen, Faktor Verlag 2021

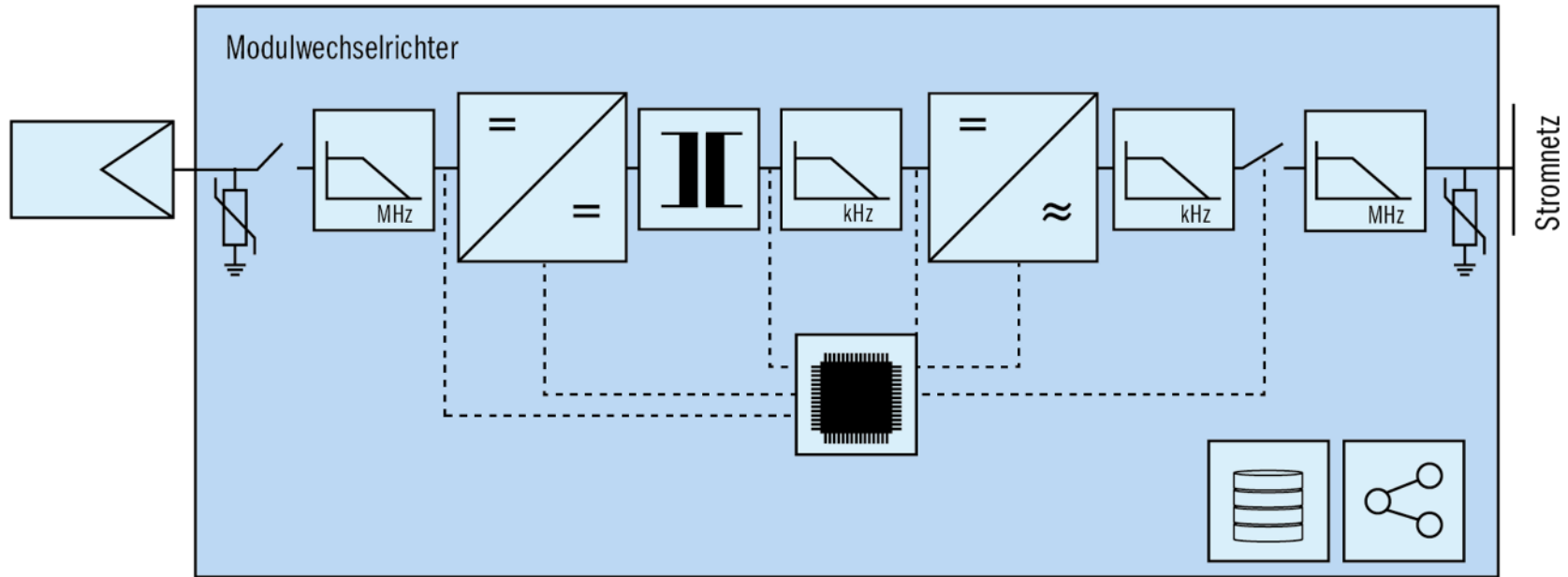

Quelle: Christof Bucher, Photovoltaikanlagen, Faktor Verlag 2021

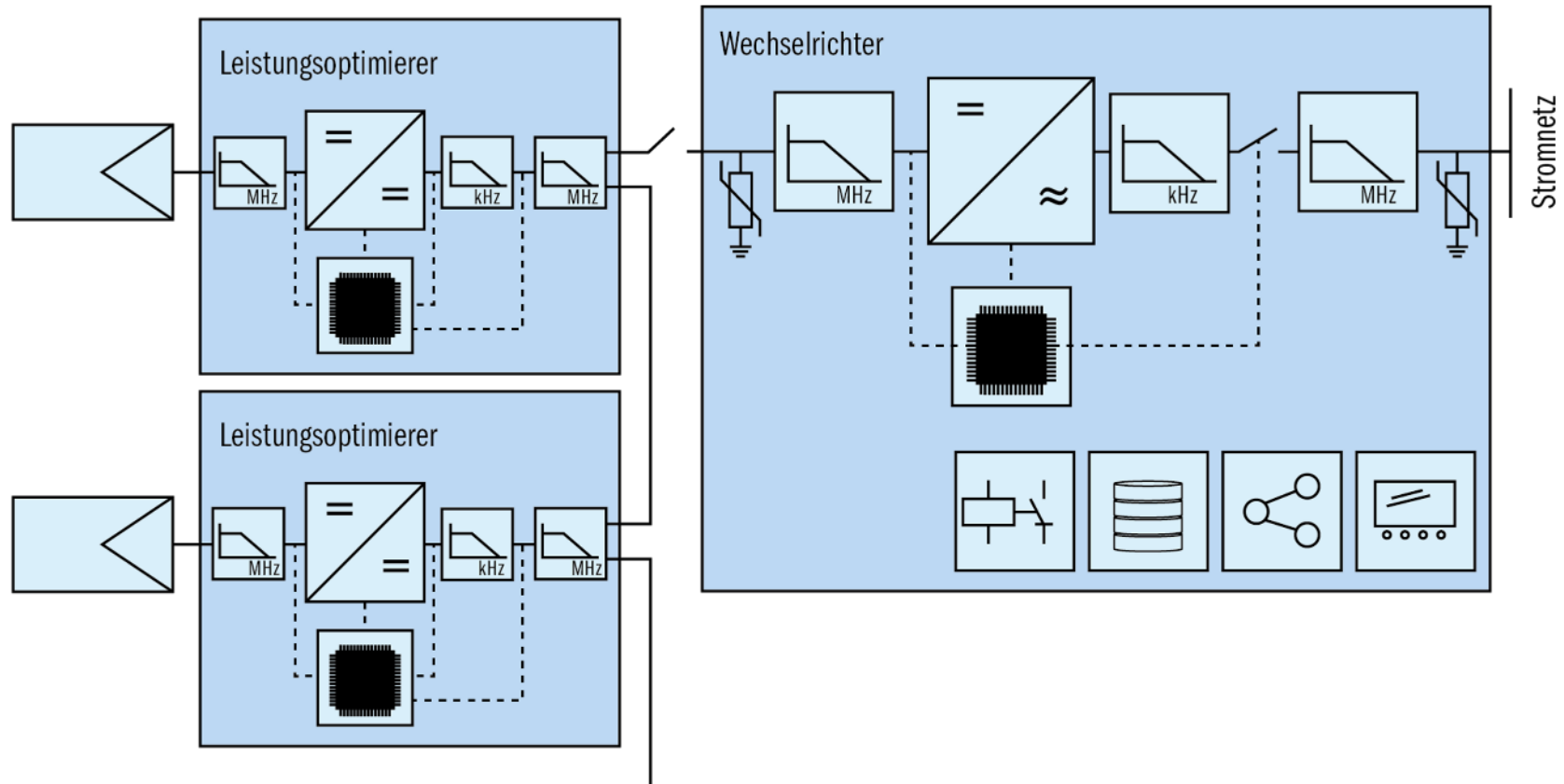

Quelle: Christof Bucher, Photovoltaikanlagen, Faktor Verlag 2021

Wirkungsgrad in %

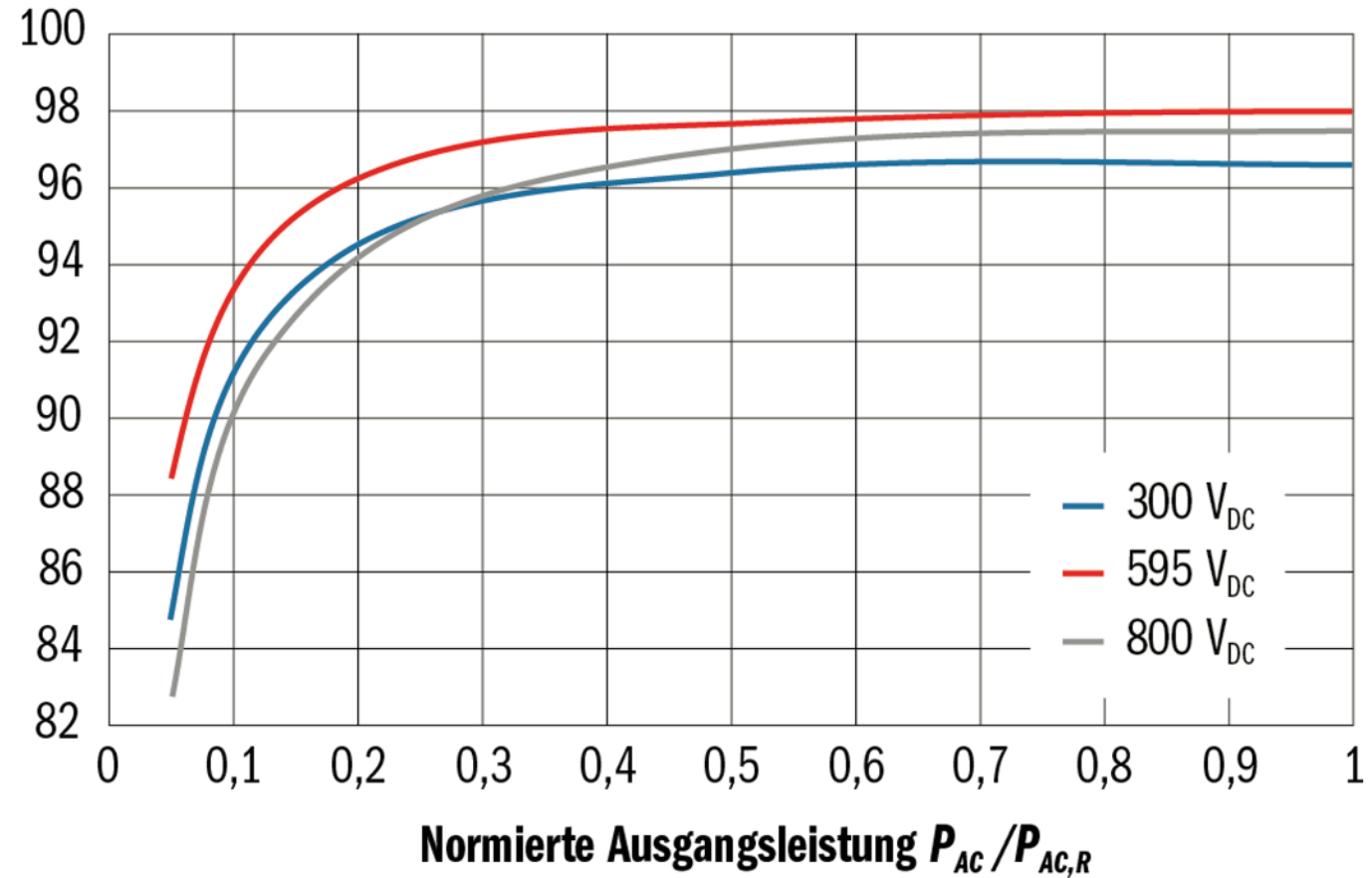

Quelle: Christof Bucher, Photovoltaikanlagen, Faktor Verlag 2021

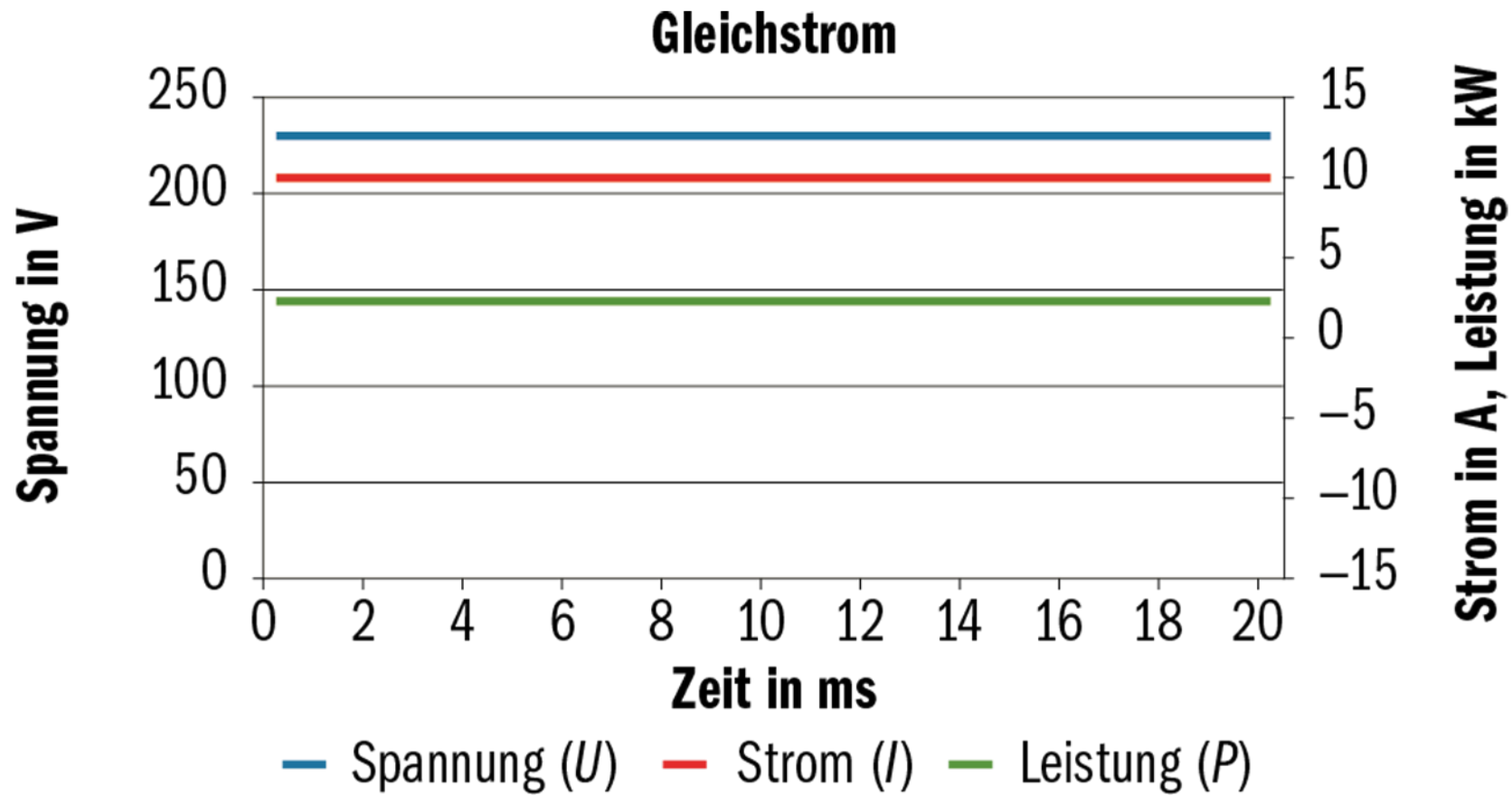

Quelle: Christof Bucher, Photovoltaikanlagen, Faktor Verlag 2021

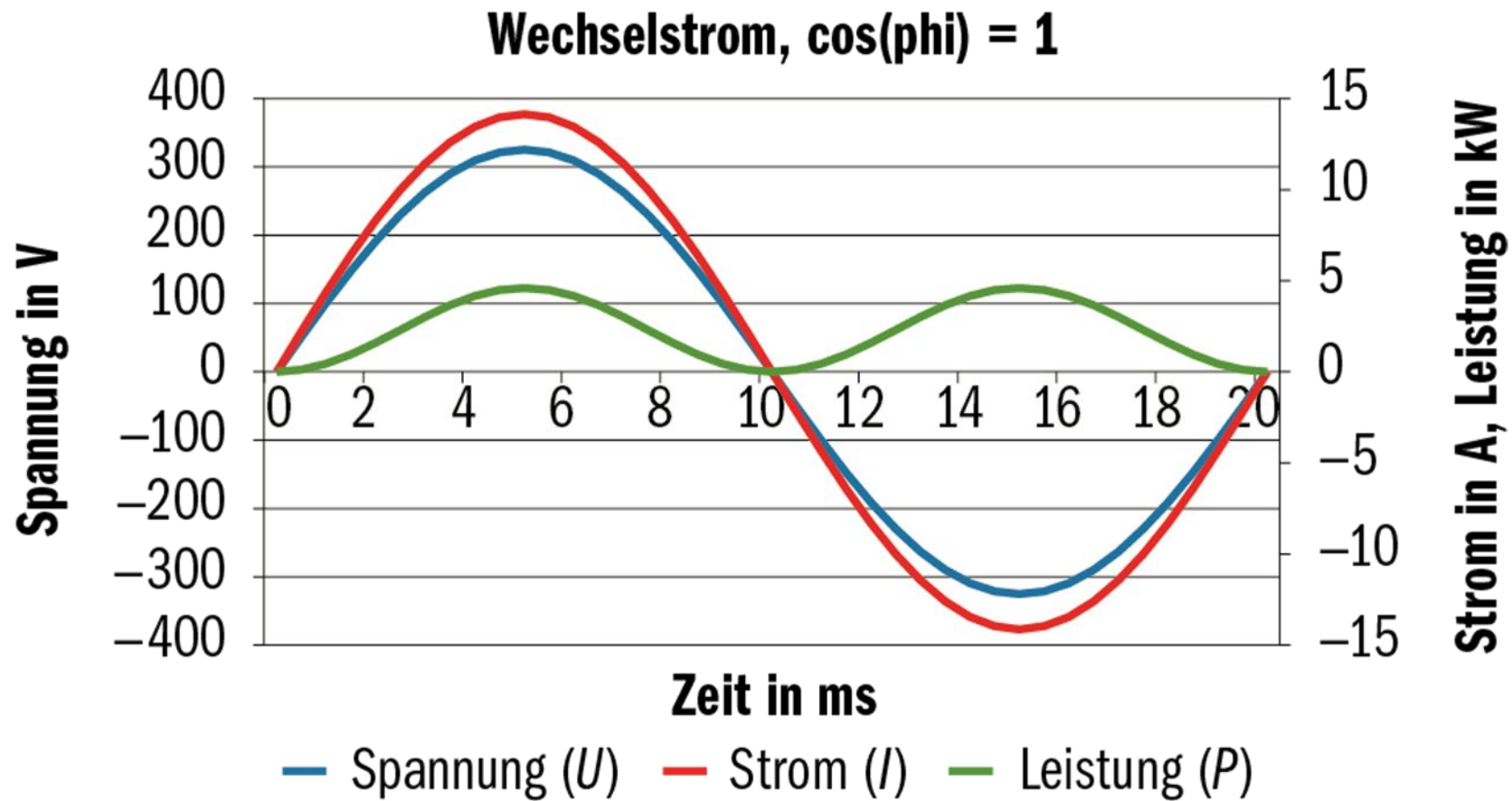

Quelle: Christof Bucher, Photovoltaikanlagen, Faktor Verlag 2021

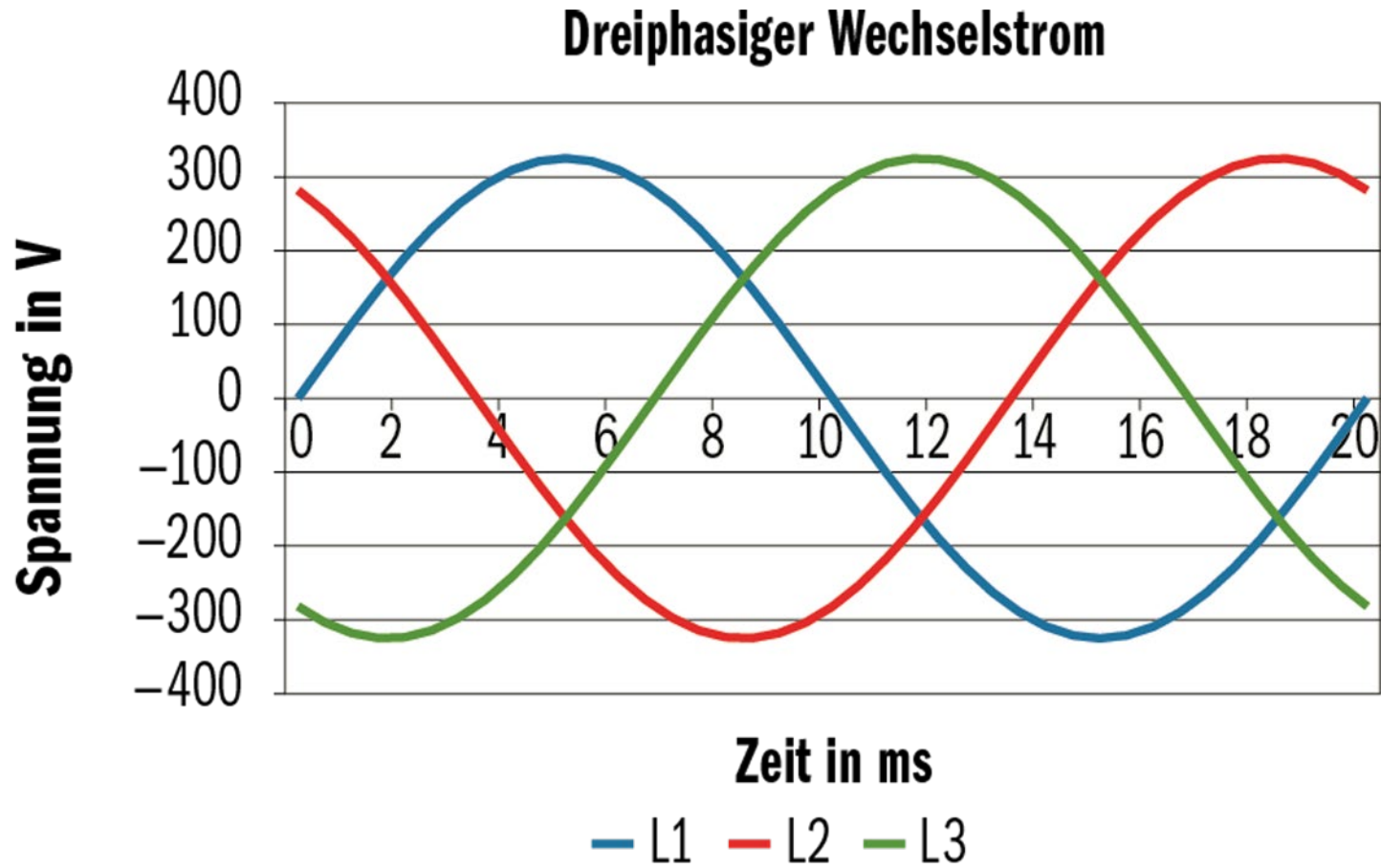

Quelle: Christof Bucher, Photovoltaikanlagen, Faktor Verlag 2021

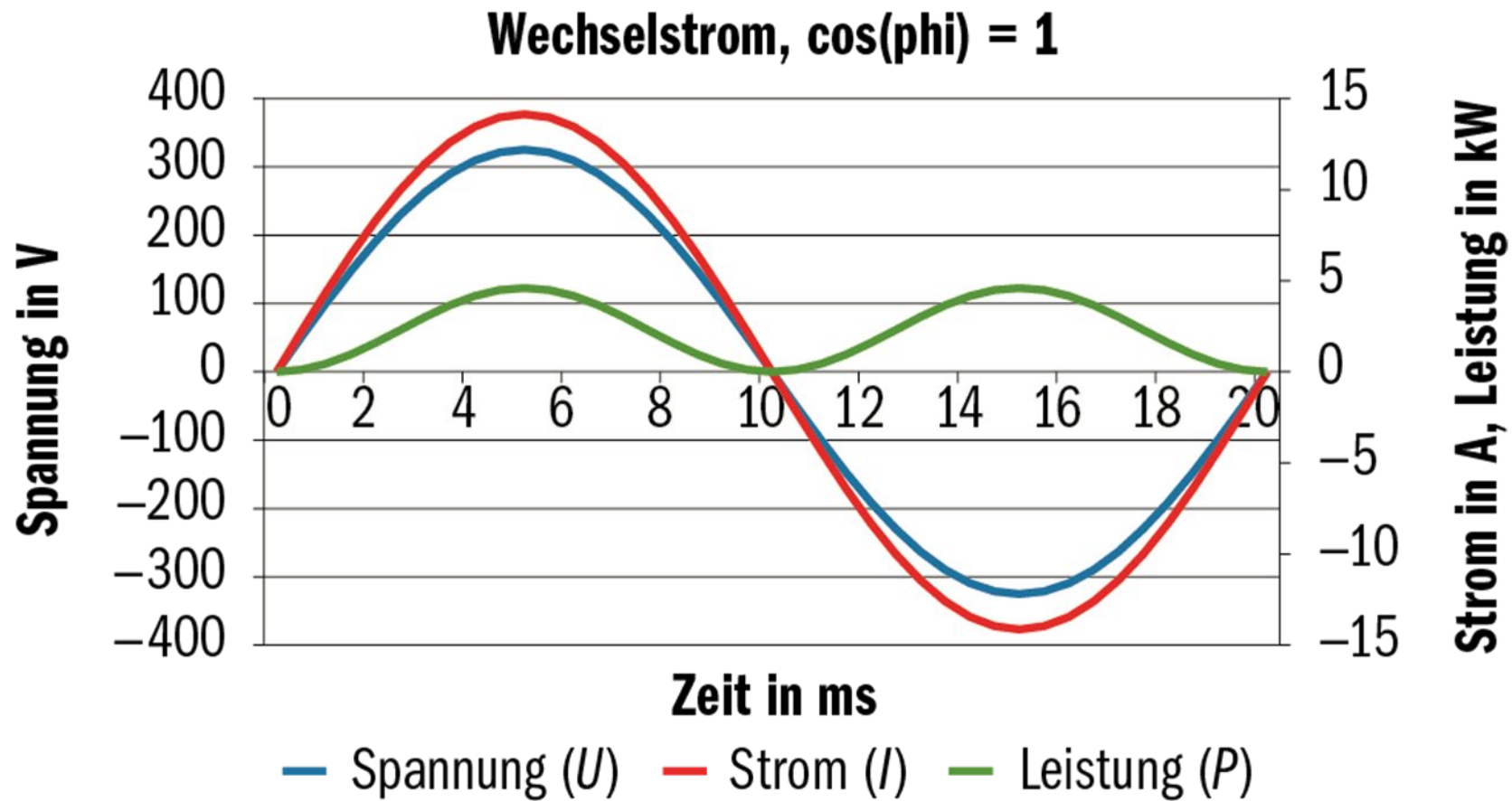

Quelle: Christof Bucher, Photovoltaikanlagen, Faktor Verlag 2021

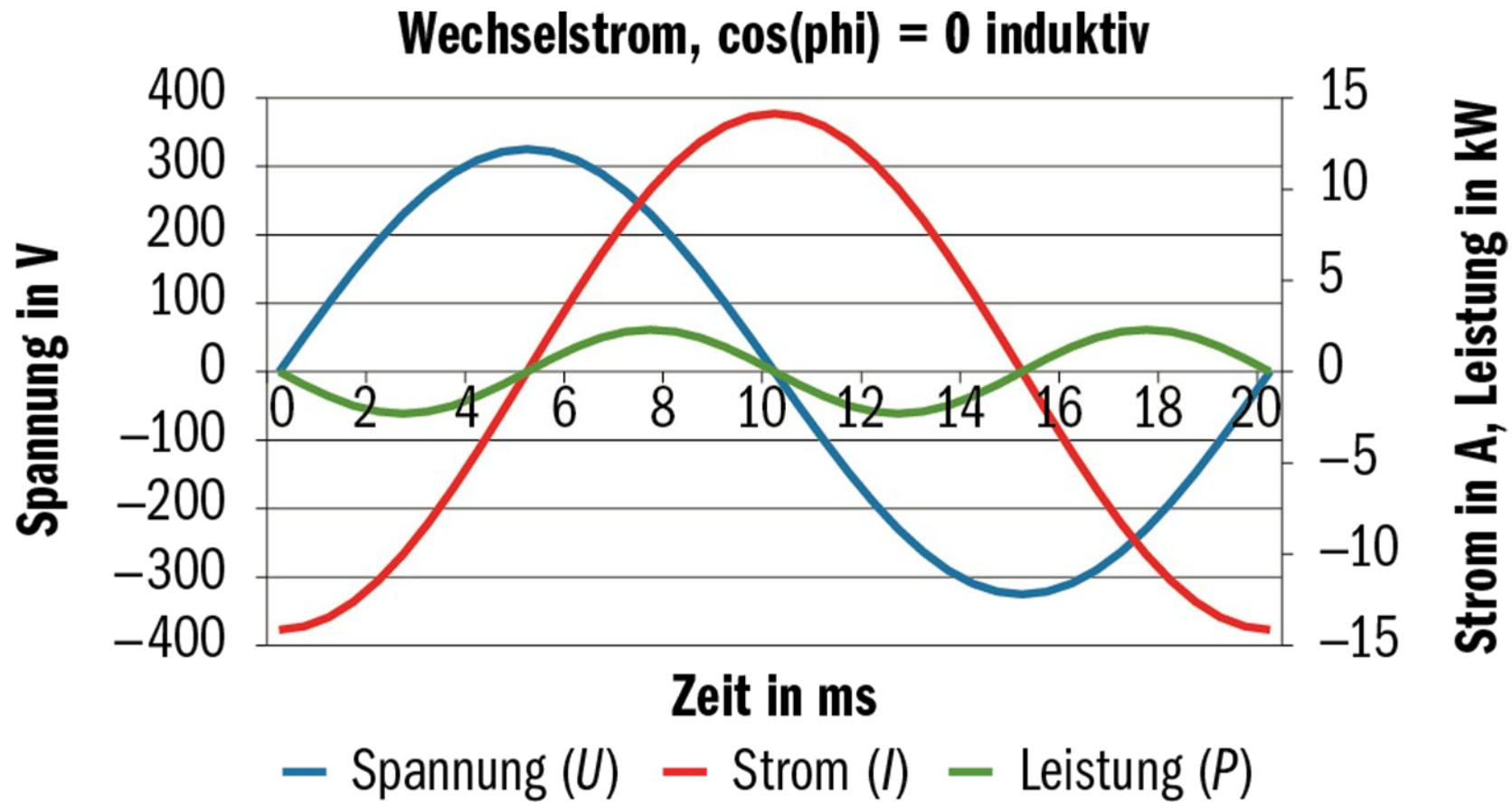

Quelle: Christof Bucher, Photovoltaikanlagen, Faktor Verlag 2021

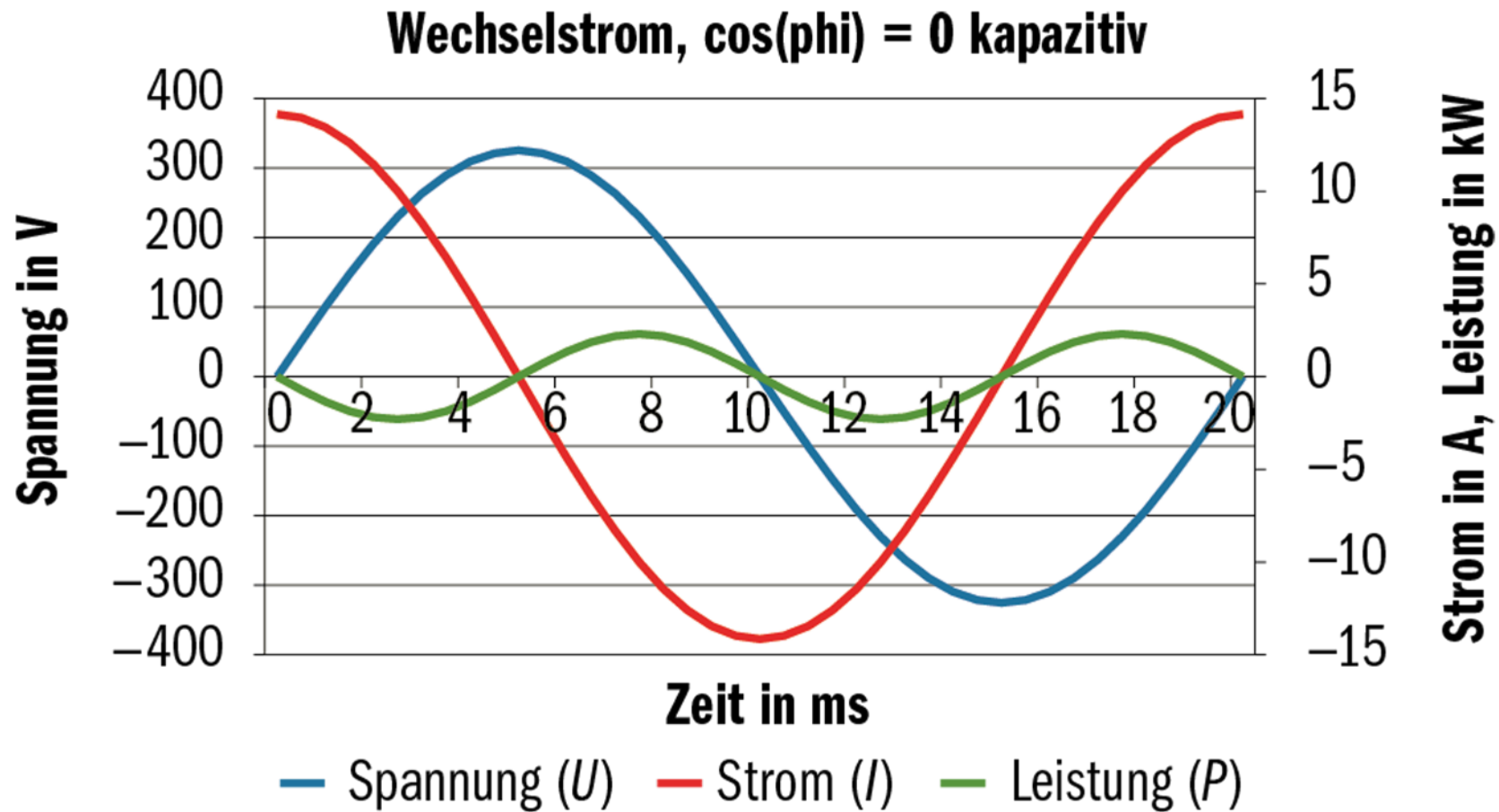

Quelle: Christof Bucher, Photovoltaikanlagen, Faktor Verlag 2021

Energiedichte in Wh/dm³

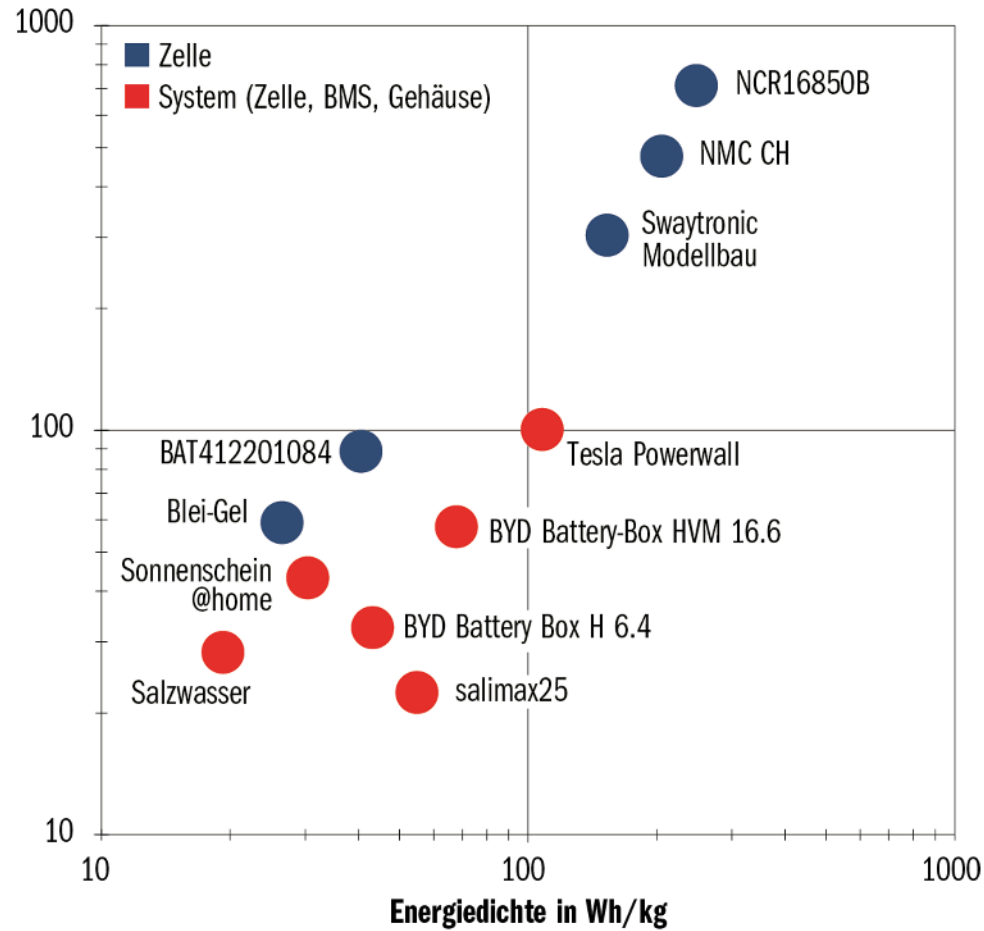

Quelle: Christof Bucher, Photovoltaikanlagen, Faktor Verlag 2021

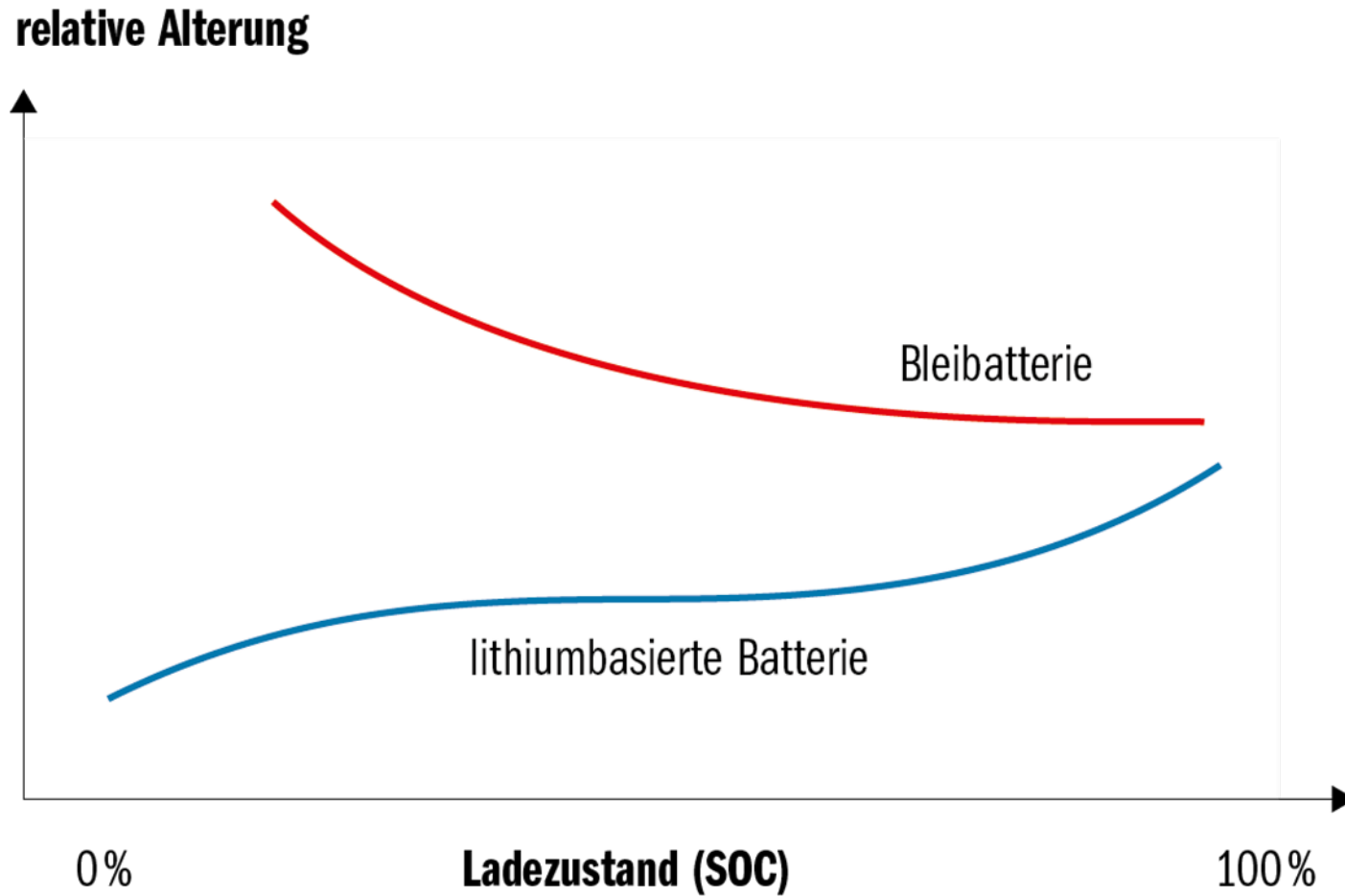

Quelle: Christof Bucher, Photovoltaikanlagen, Faktor Verlag 2021

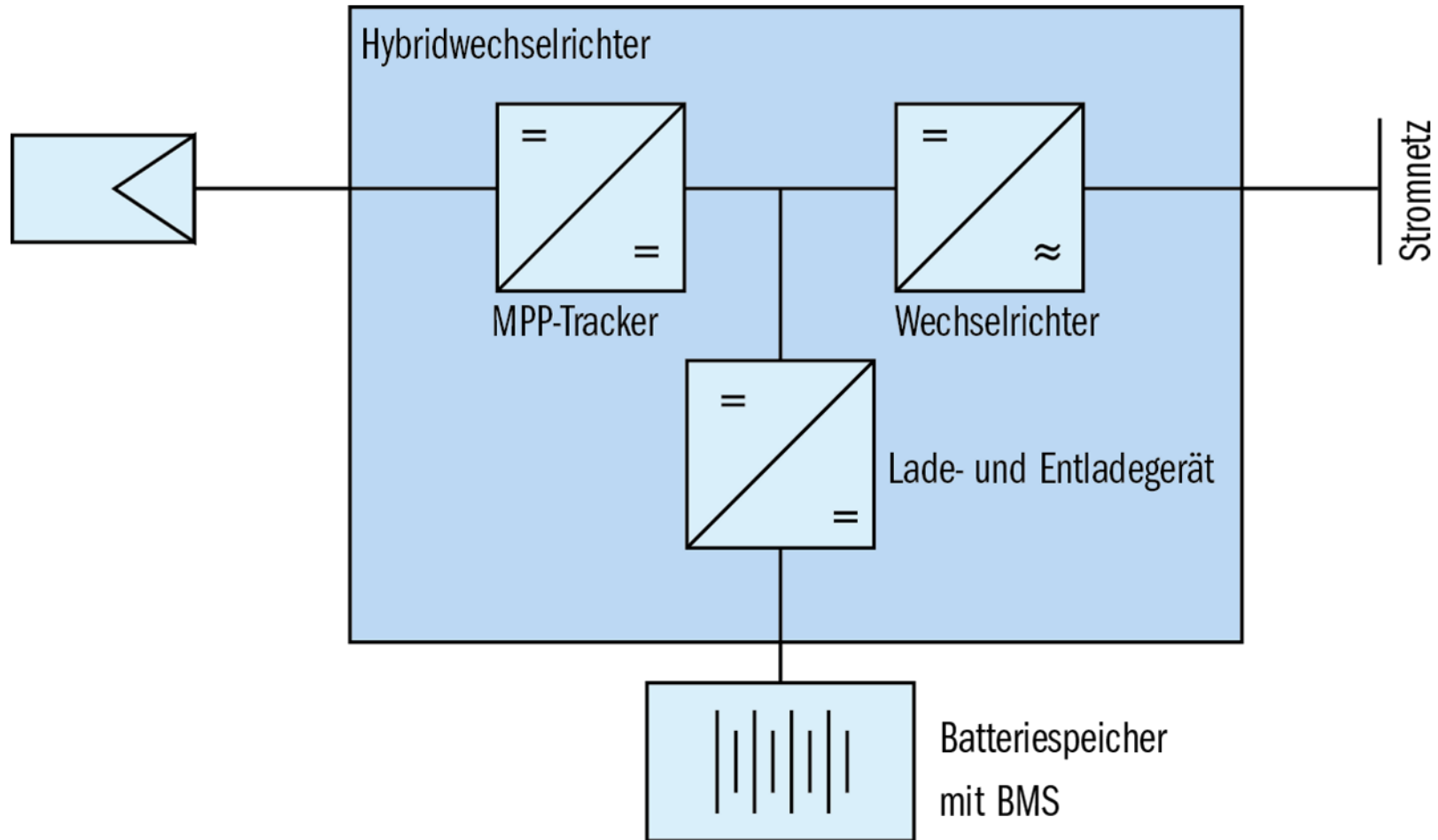

Quelle: Christof Bucher, Photovoltaikanlagen, Faktor Verlag 2021

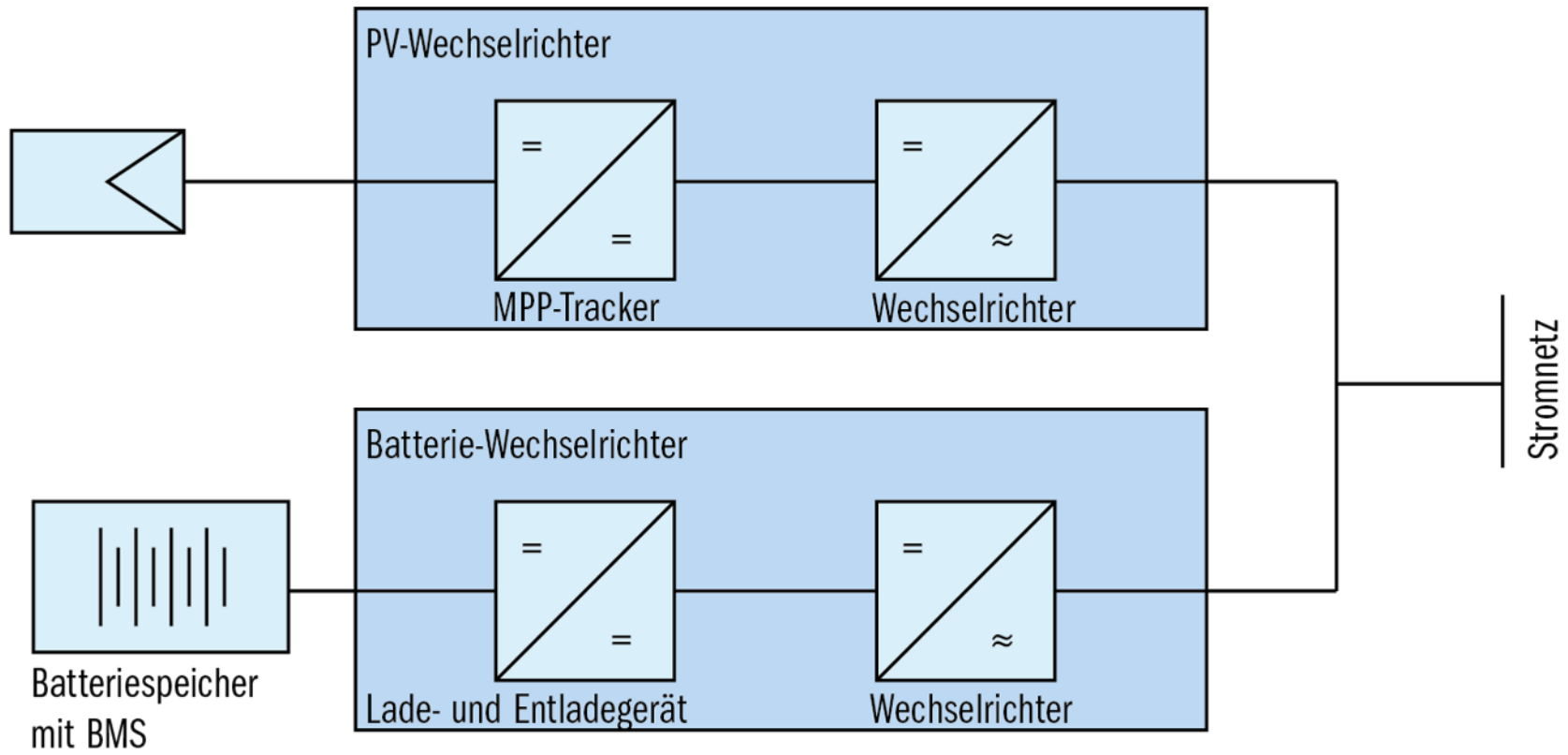

Quelle: Christof Bucher, Photovoltaikanlagen, Faktor Verlag 2021

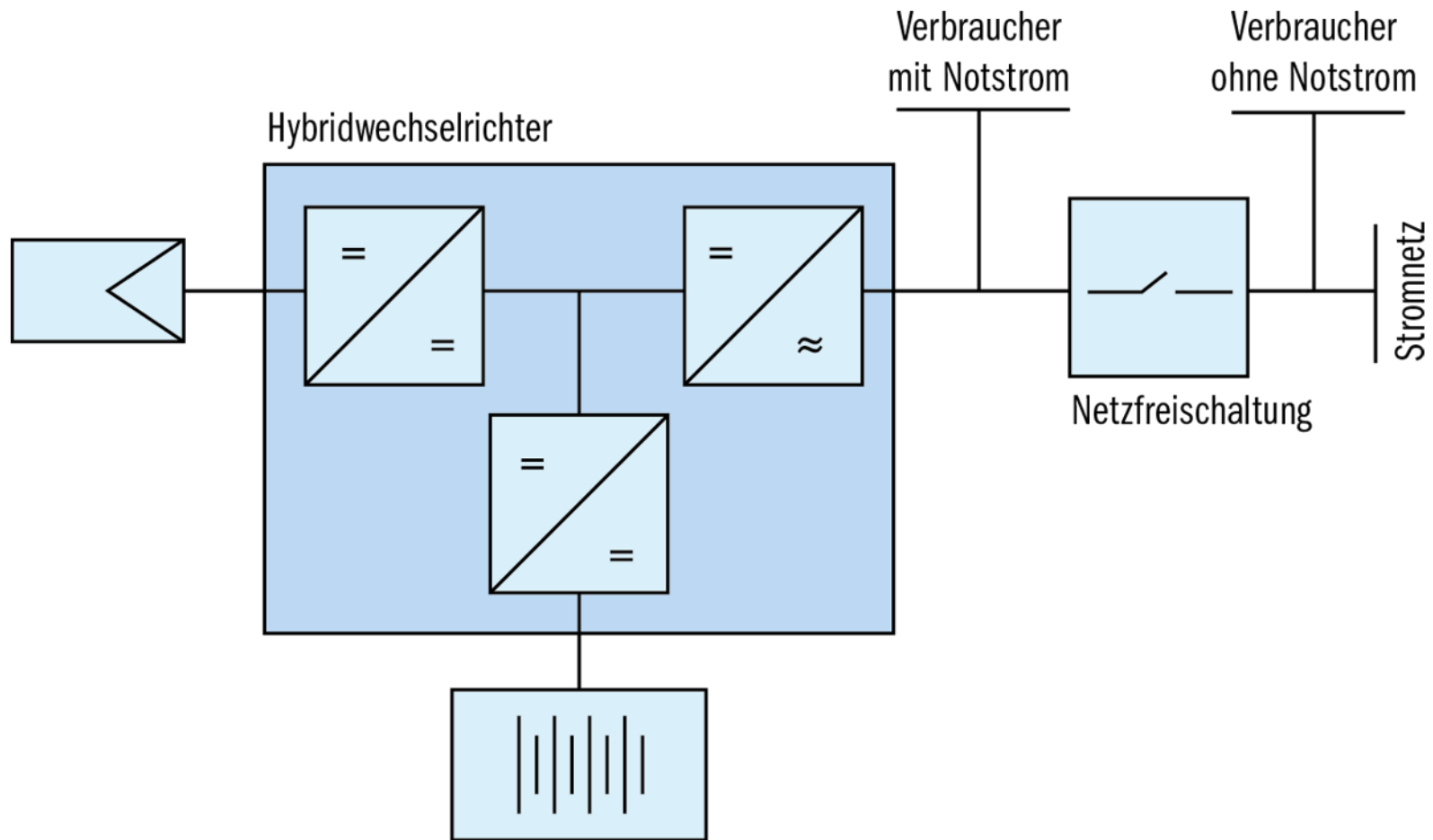

Quelle: Christof Bucher, Photovoltaikanlagen, Faktor Verlag 2021

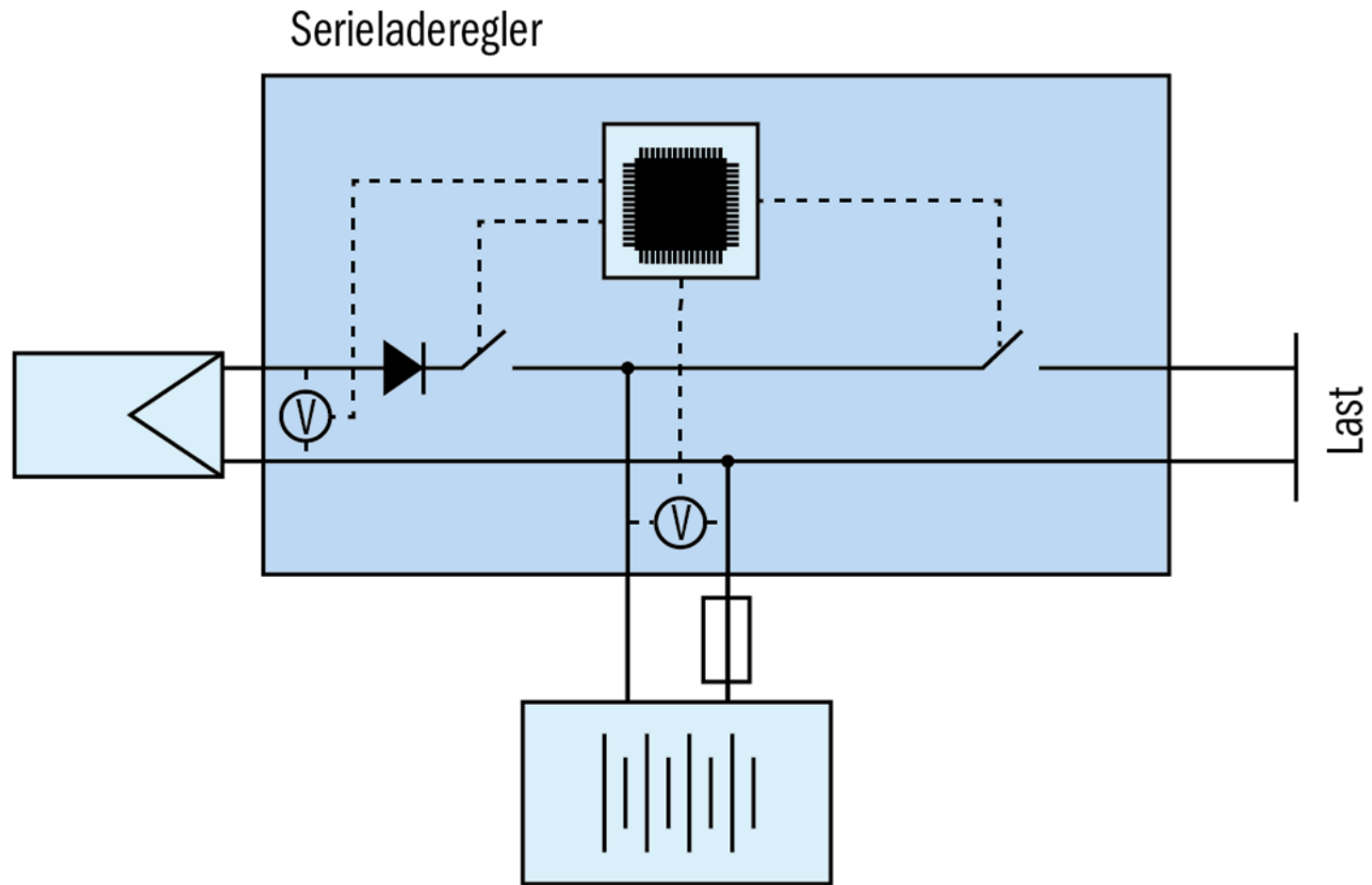

Quelle: Christof Bucher, Photovoltaikanlagen, Faktor Verlag 2021

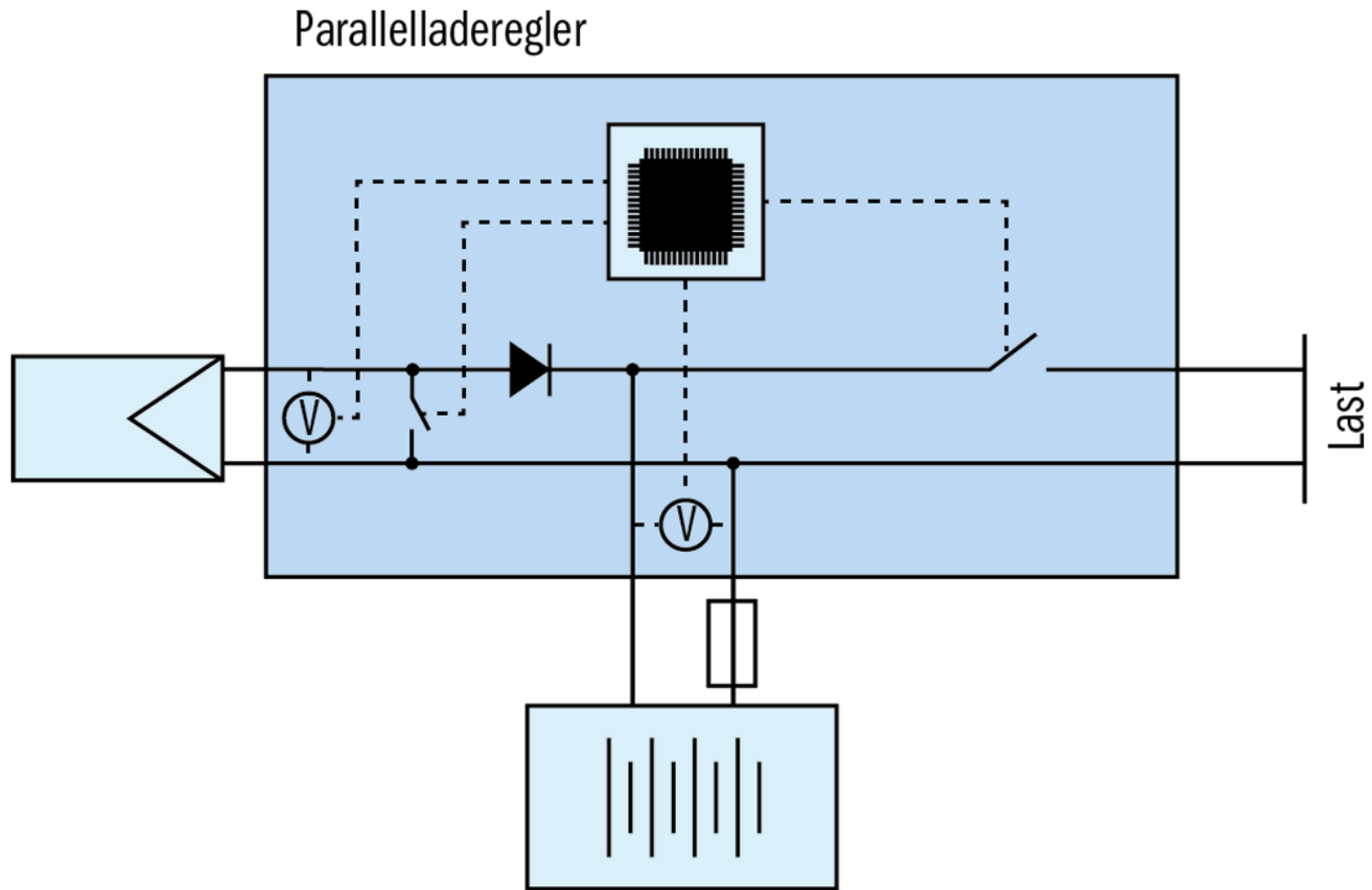

Quelle: Christof Bucher, Photovoltaikanlagen, Faktor Verlag 2021

PWM-Laderegler (Serie)

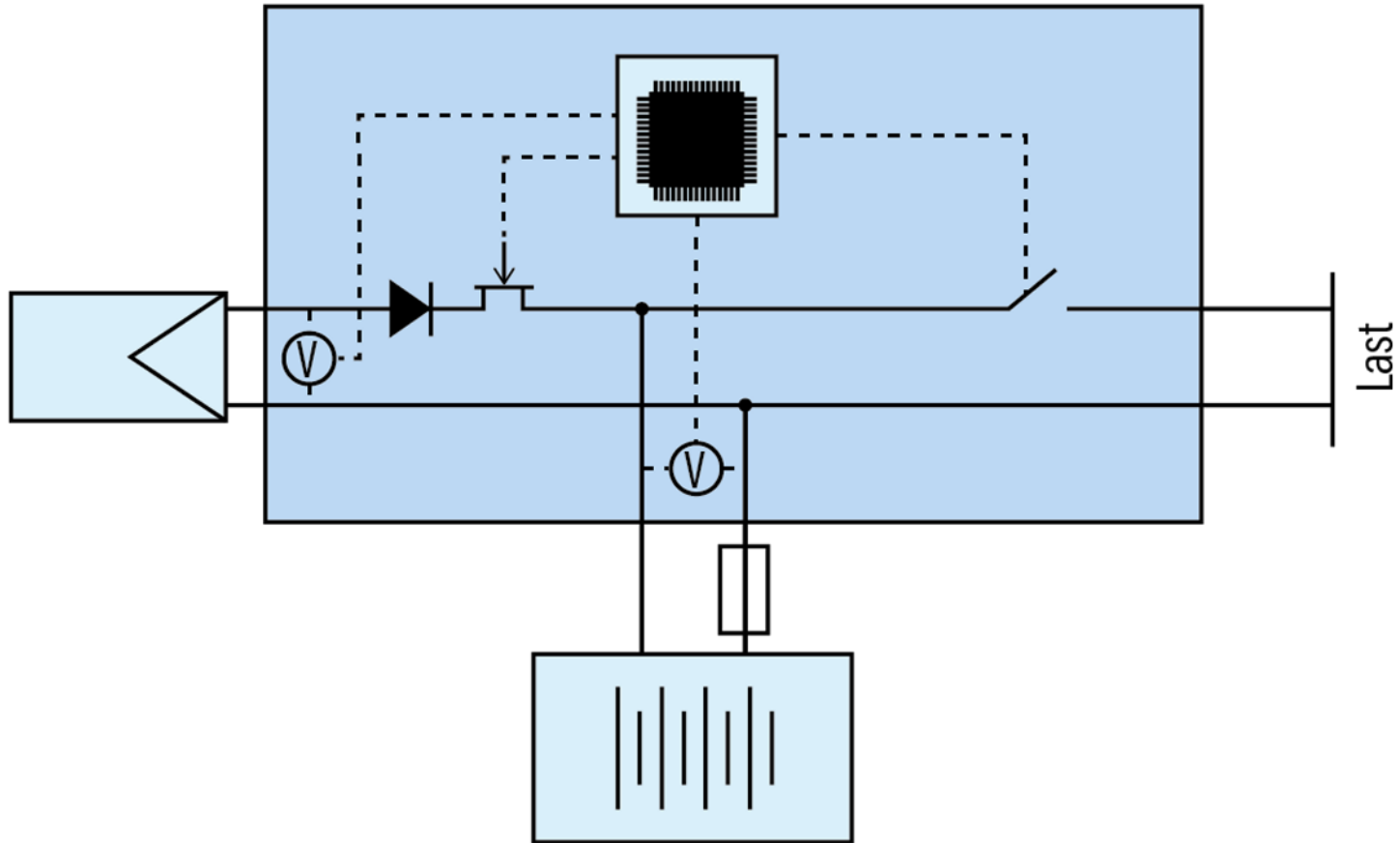

Quelle: Christof Bucher, Photovoltaikanlagen, Faktor Verlag 2021

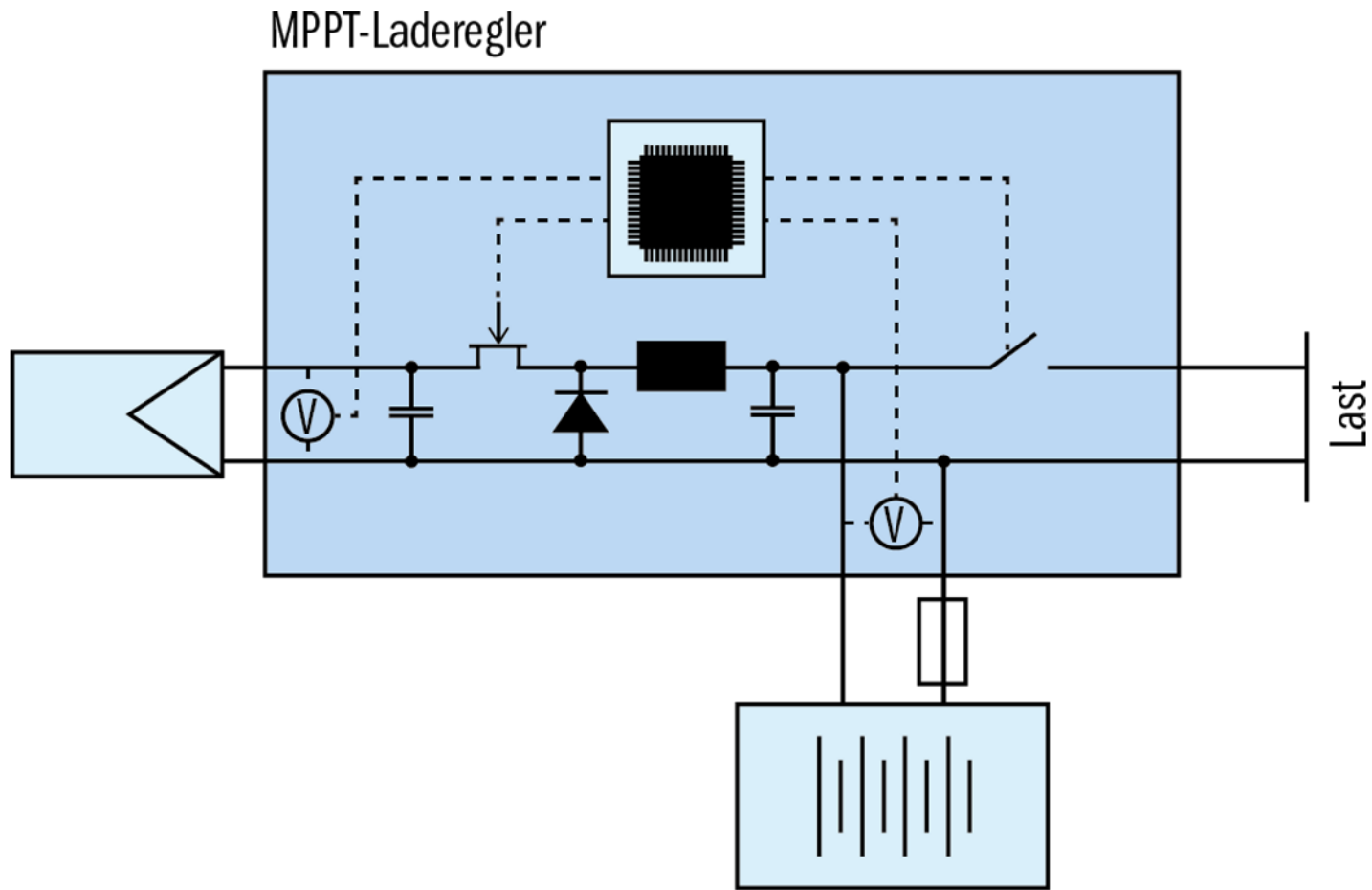

Quelle: Christof Bucher, Photovoltaikanlagen, Faktor Verlag 2021

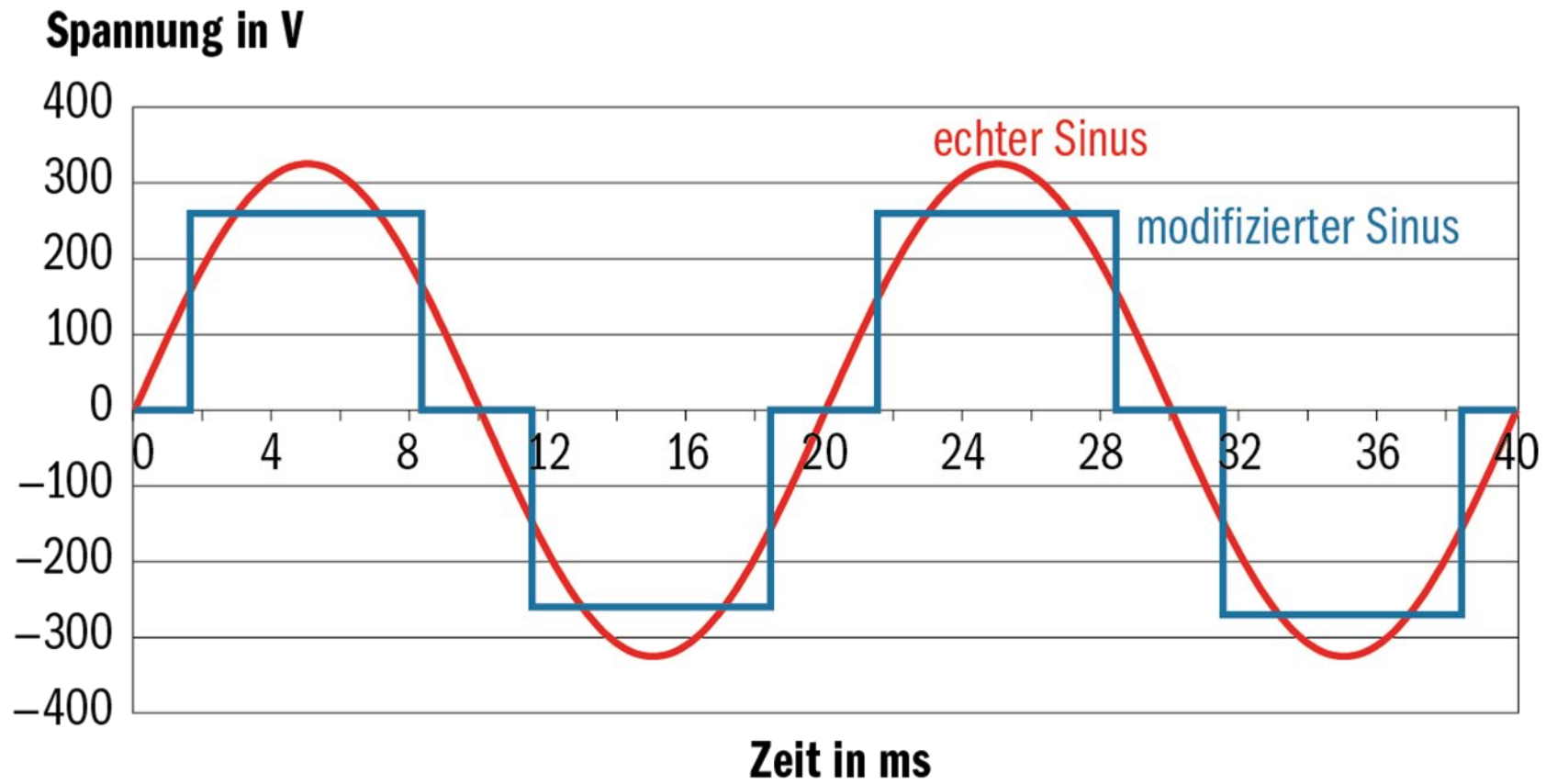

Quelle: Christof Bucher, Photovoltaikanlagen, Faktor Verlag 2021

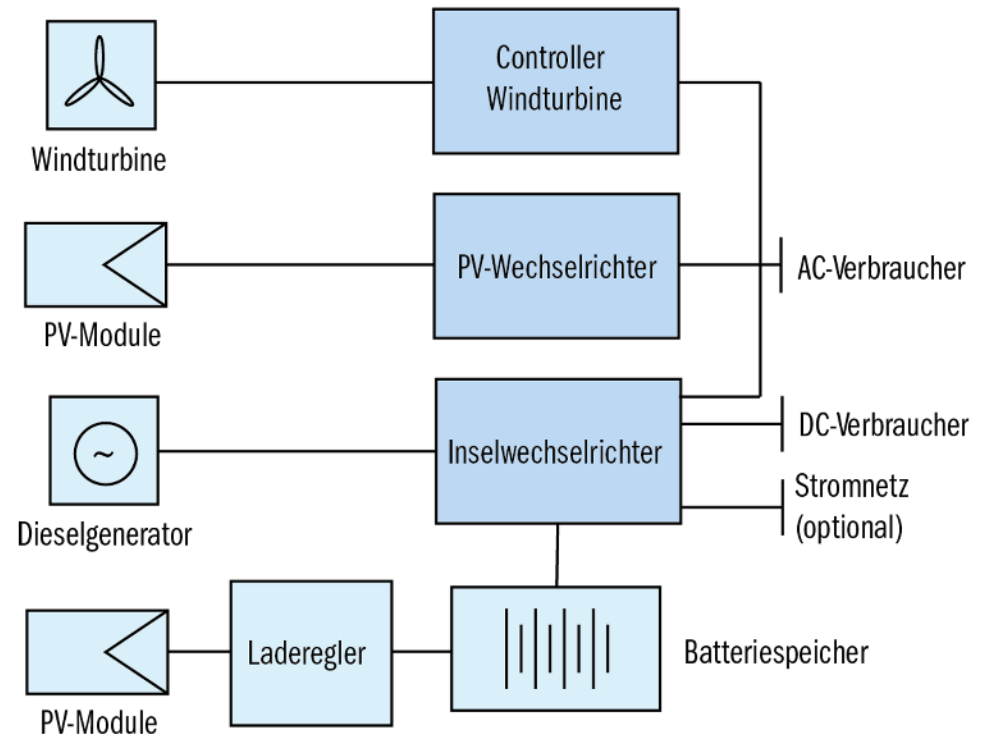
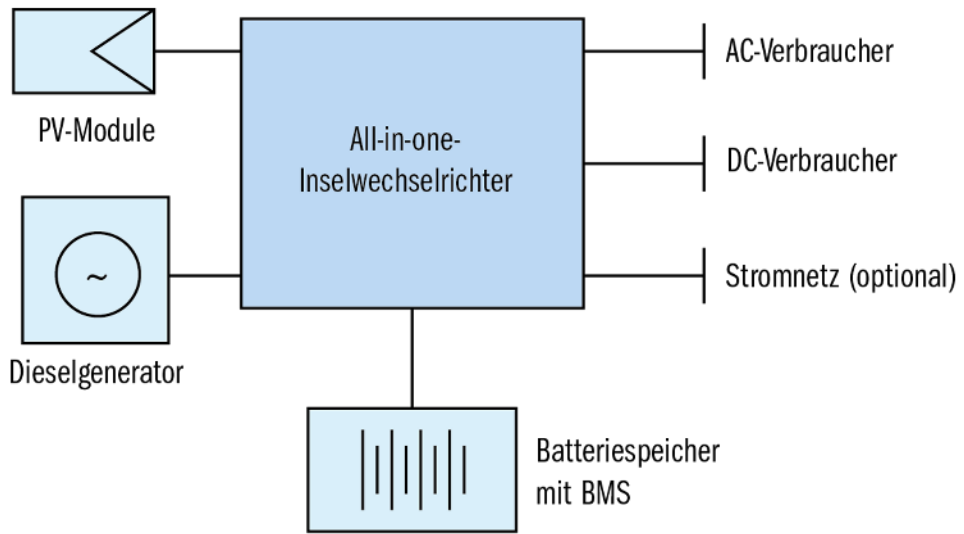

Quelle: Christof Bucher, Photovoltaikanlagen, Faktor Verlag 2021

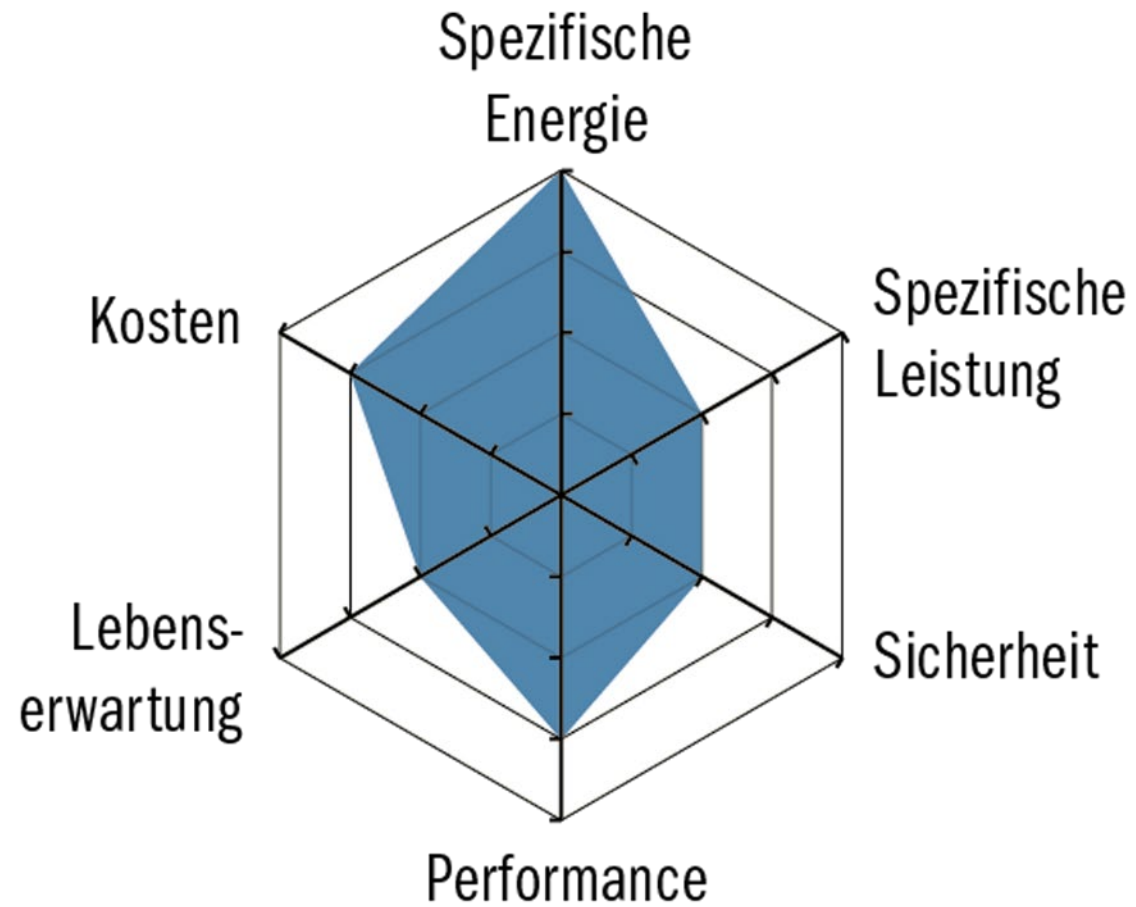

Quelle: Christof Bucher, Photovoltaikanlagen, Faktor Verlag 2021

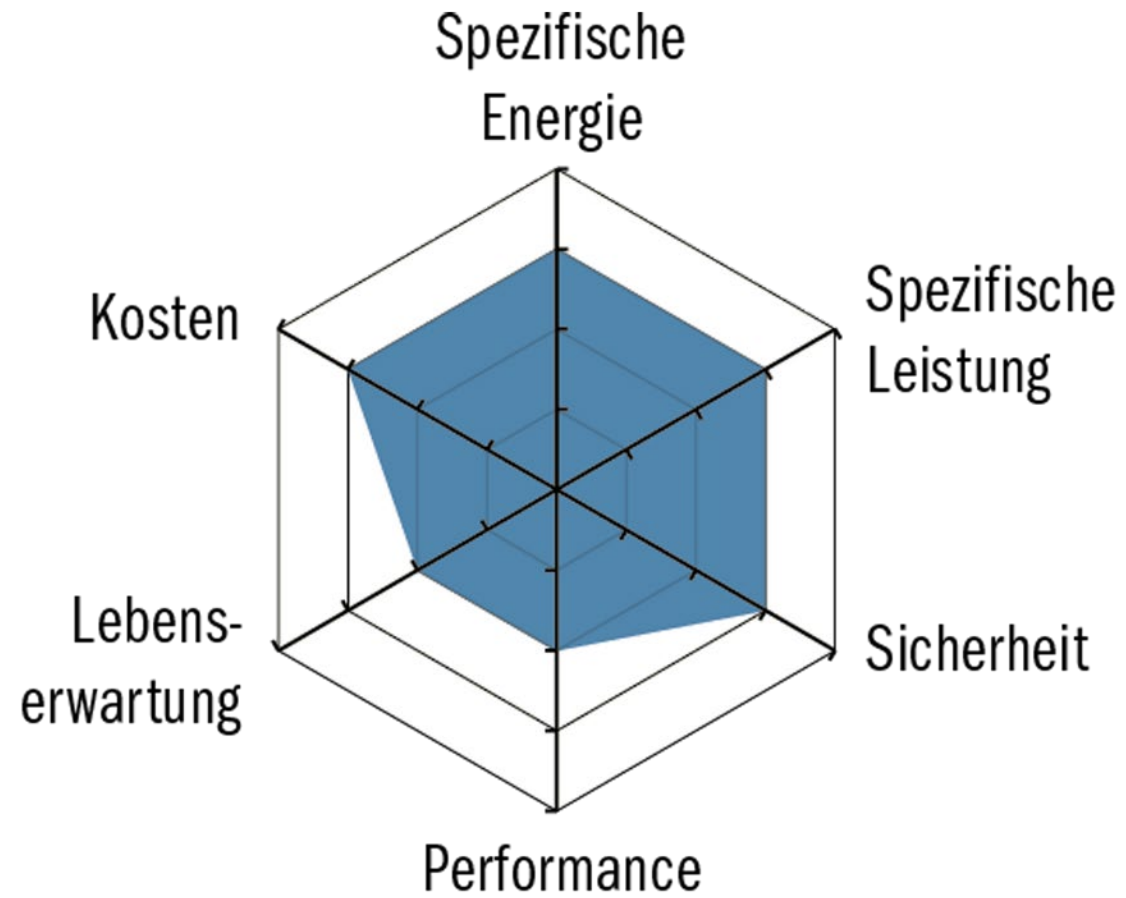

Quelle: Christof Bucher, Photovoltaikanlagen, Faktor Verlag 2021

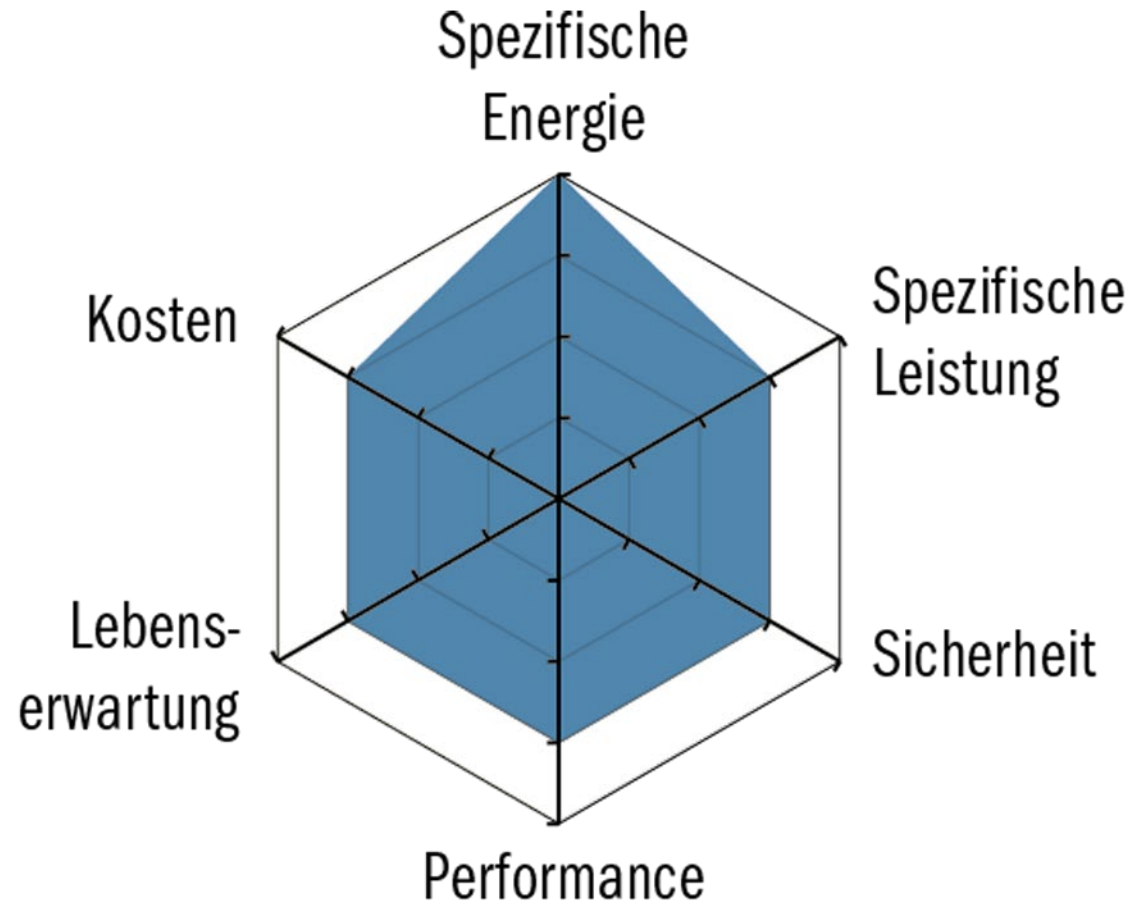

Quelle: Christof Bucher, Photovoltaikanlagen, Faktor Verlag 2021

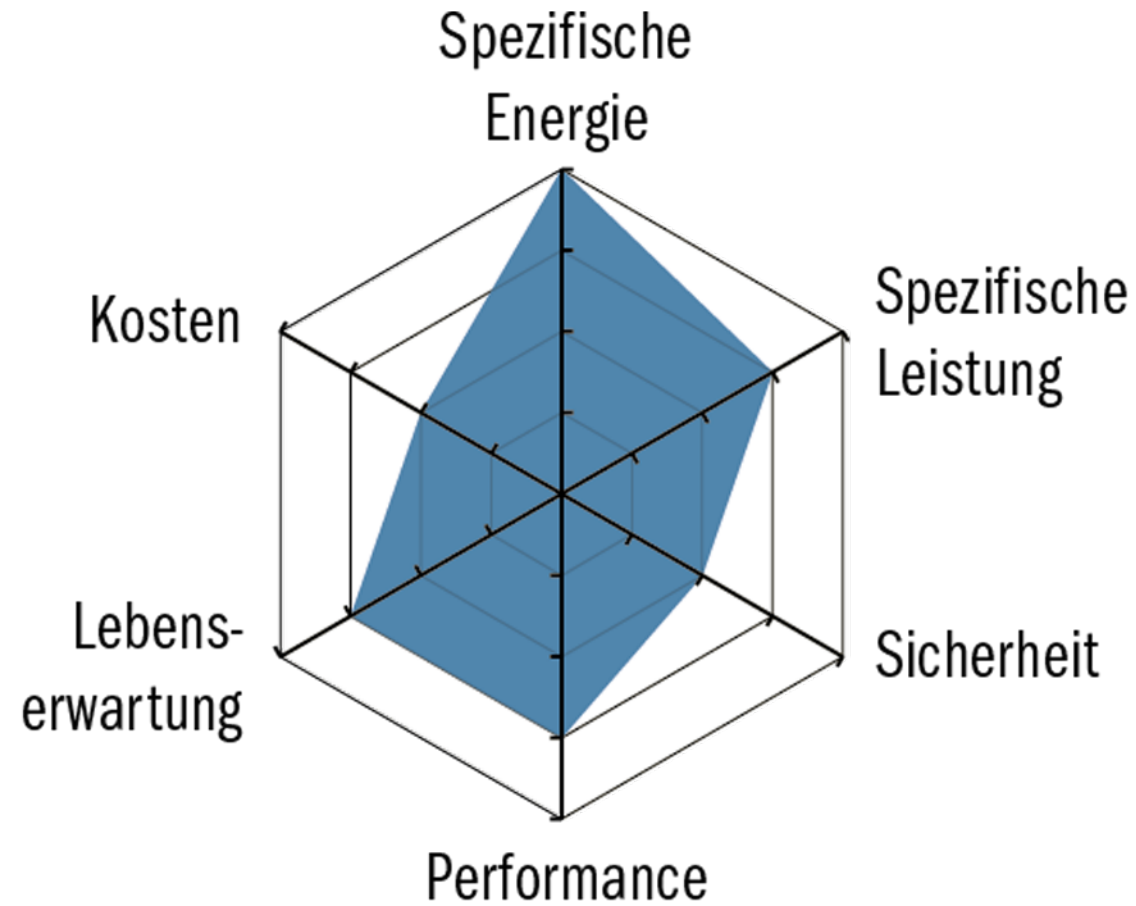

Quelle: Christof Bucher, Photovoltaikanlagen, Faktor Verlag 2021

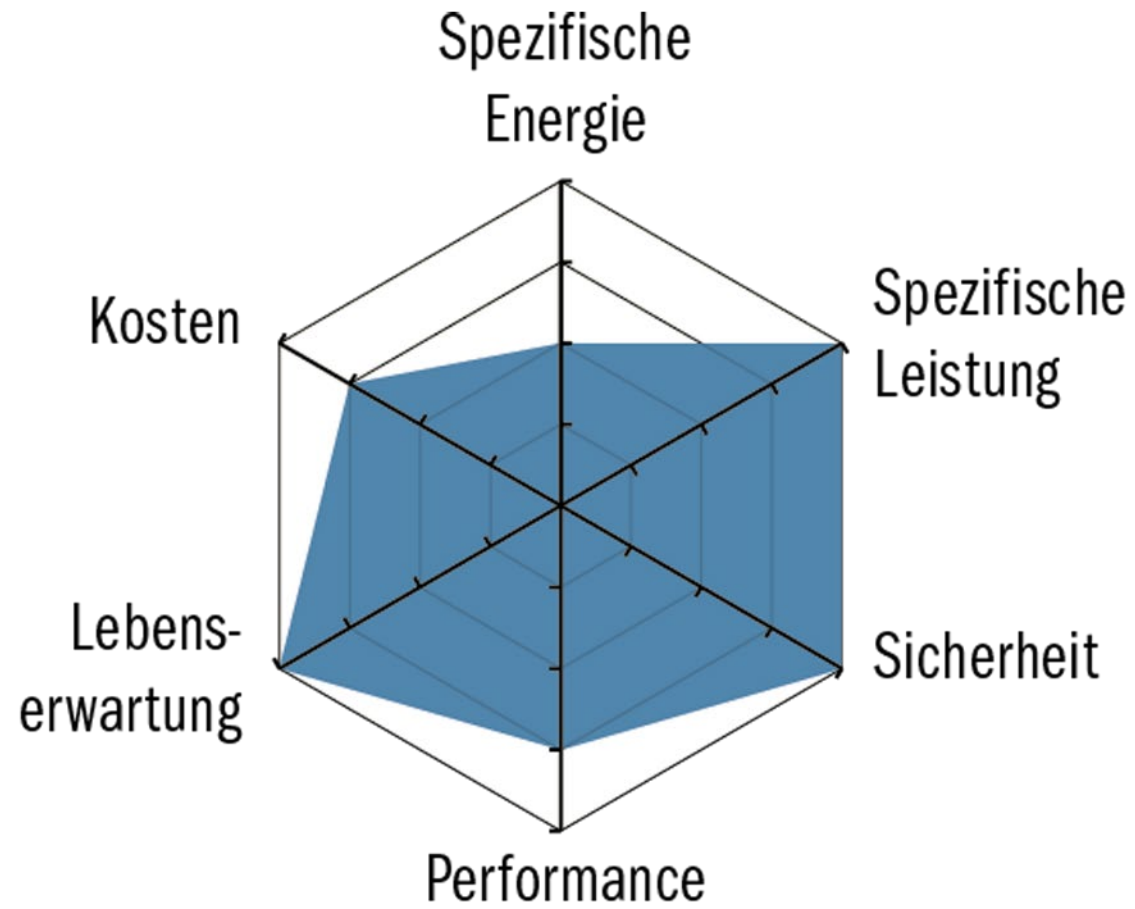

Quelle: Christof Bucher, Photovoltaikanlagen, Faktor Verlag 2021

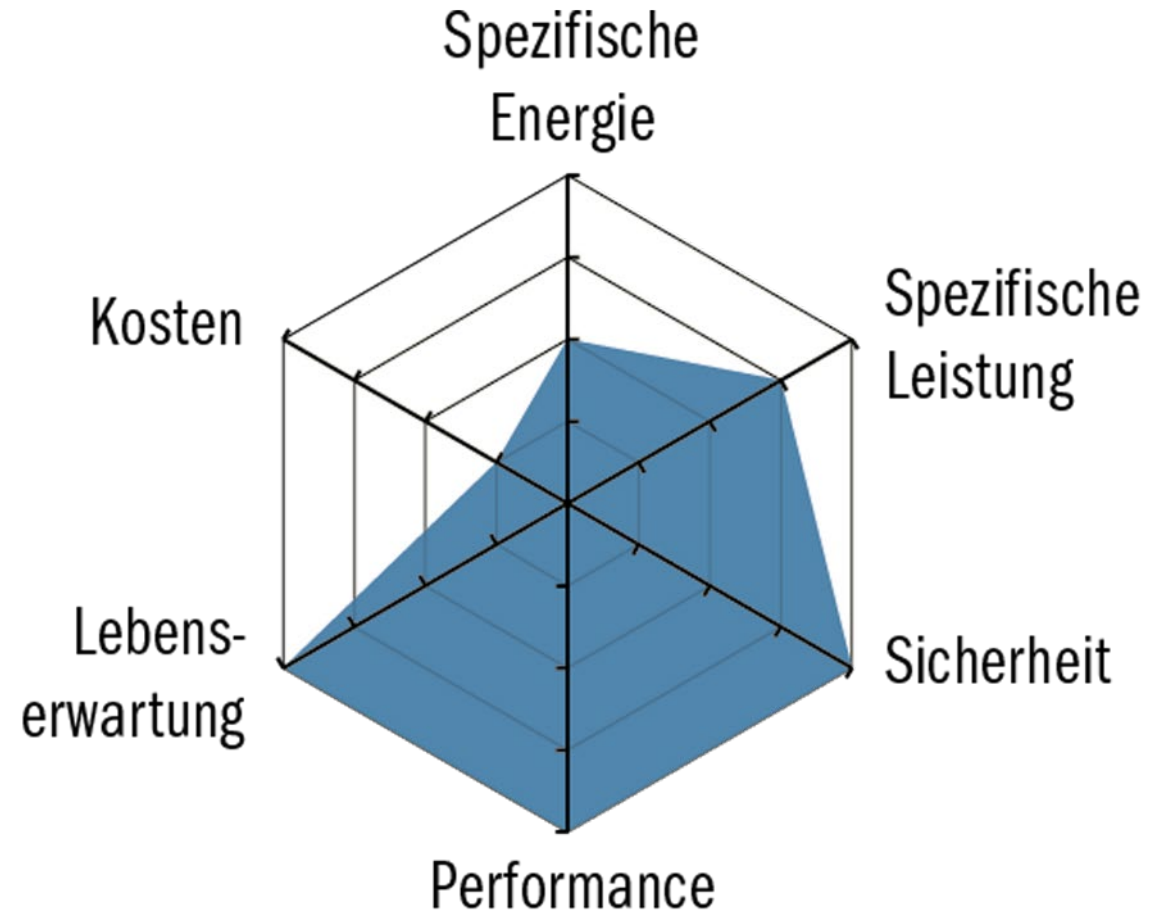

Quelle: Christof Bucher, Photovoltaikanlagen, Faktor Verlag 2021

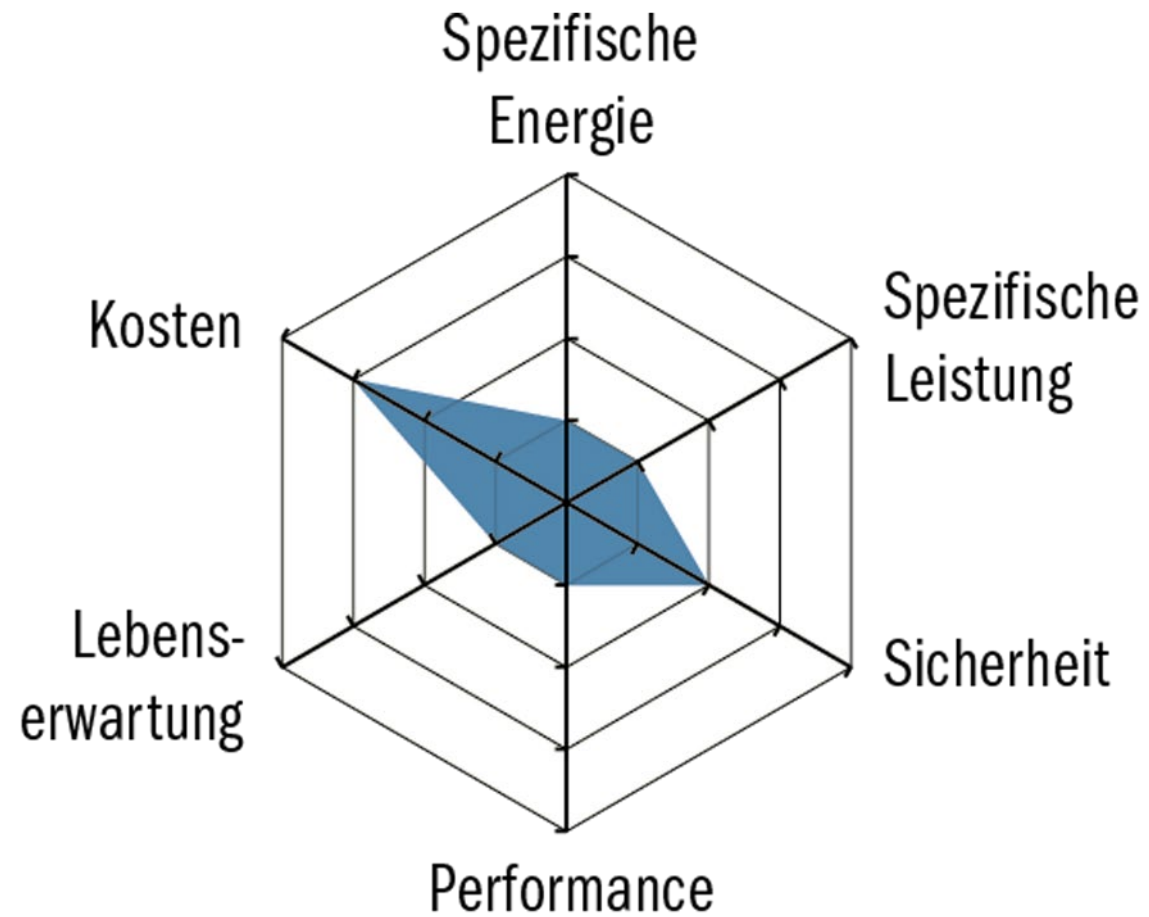

Quelle: Christof Bucher, Photovoltaikanlagen, Faktor Verlag 2021

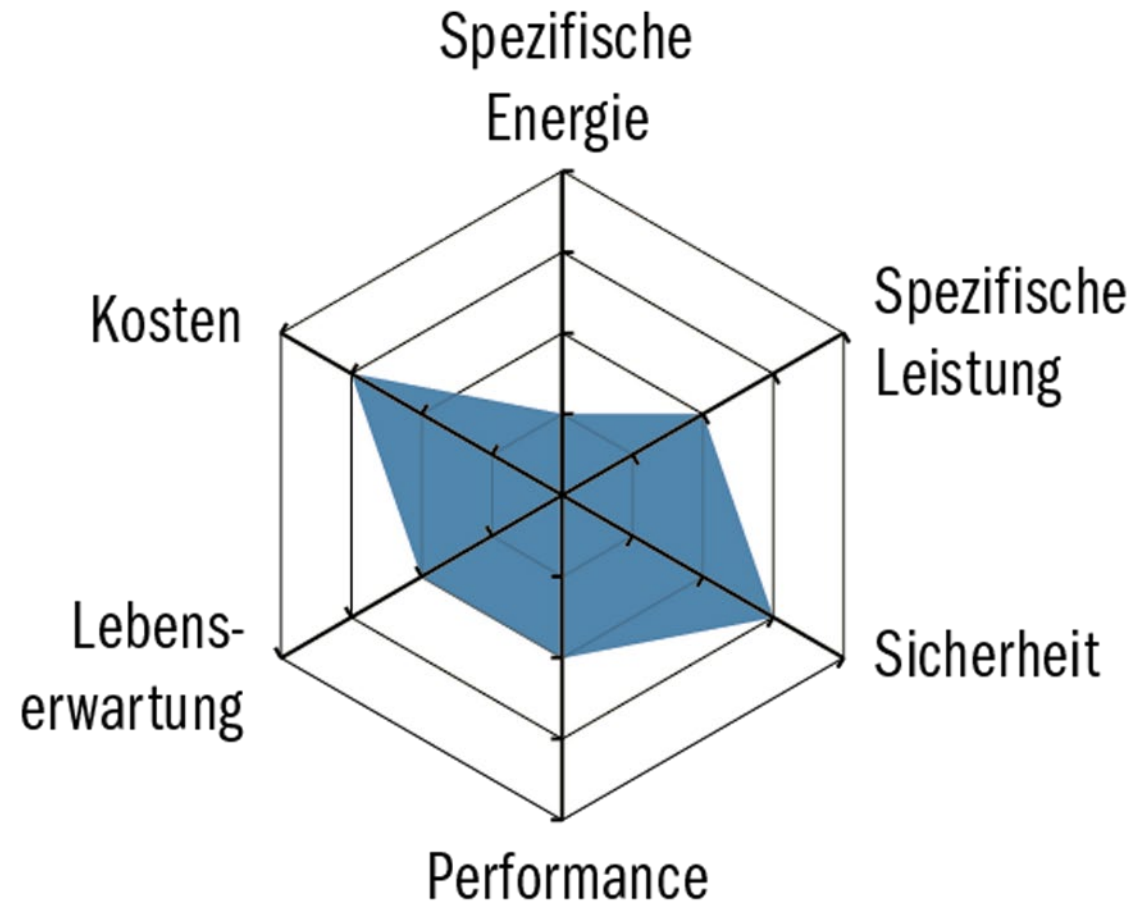

Quelle: Christof Bucher, Photovoltaikanlagen, Faktor Verlag 2021

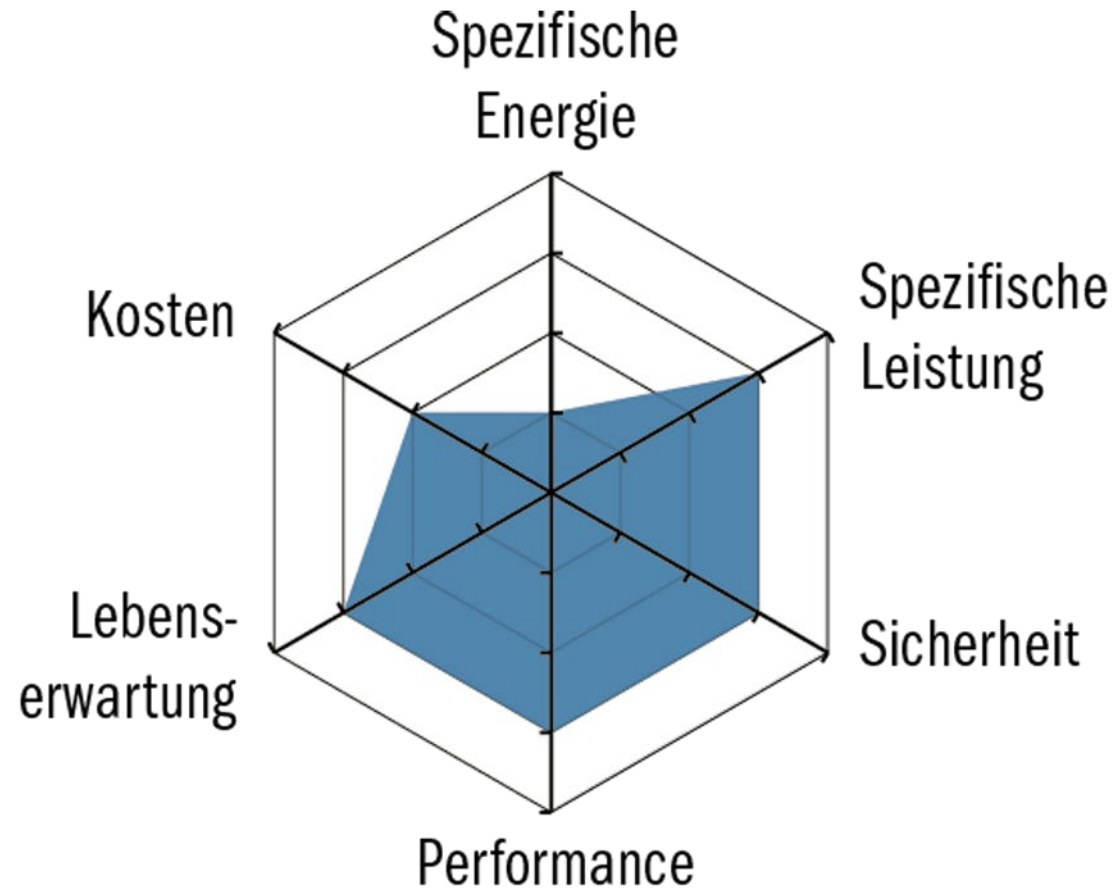

Quelle: Christof Bucher, Photovoltaikanlagen, Faktor Verlag 2021



Preis

Genauigkeit



Quelle: Christof Bucher, Photovoltaikanlagen, Faktor Verlag 2021

Spezifischer Energieertrag in kWh/kW

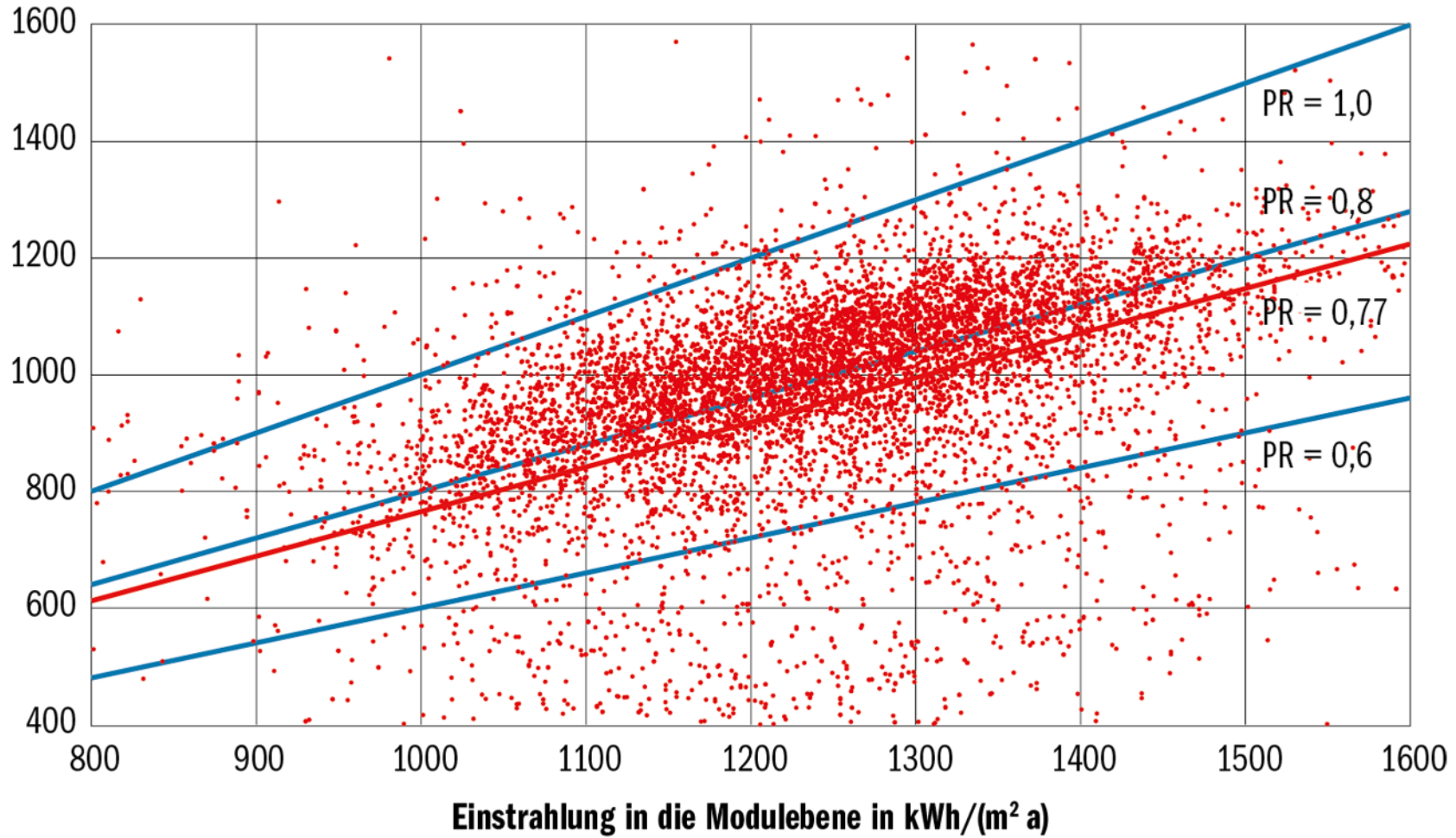

Quelle: Christof Bucher, Photovoltaikanlagen, Faktor Verlag 2021

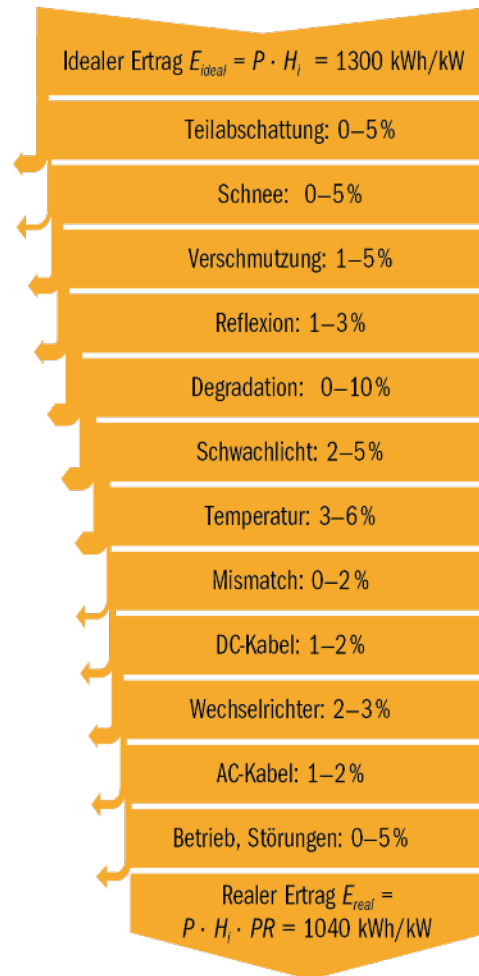

Quelle: Christof Bucher, Photovoltaikanlagen, Faktor Verlag 2021

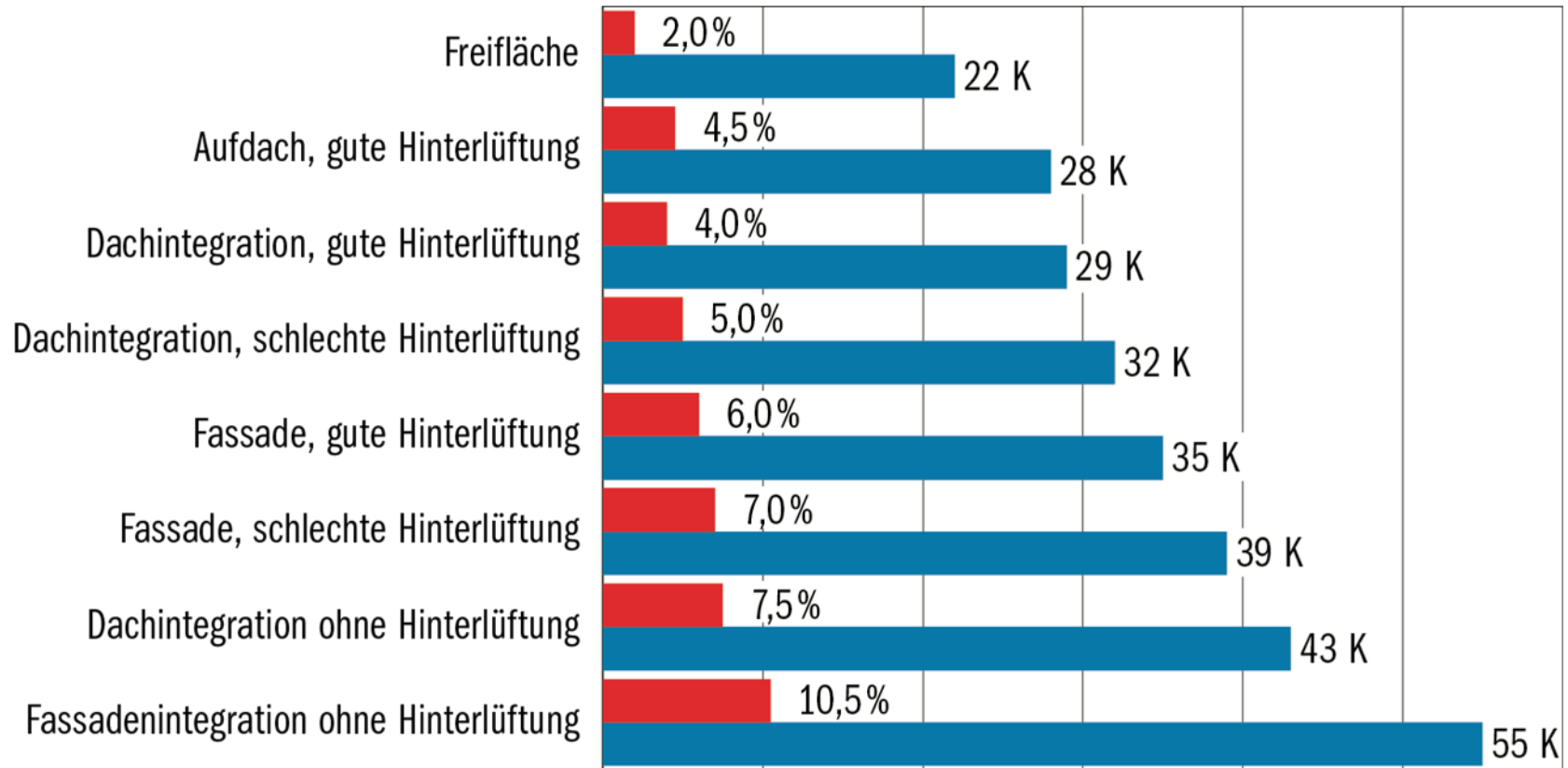

Quelle: Christof Bucher, Photovoltaikanlagen, Faktor Verlag 2021

Monatsertrag in TWh

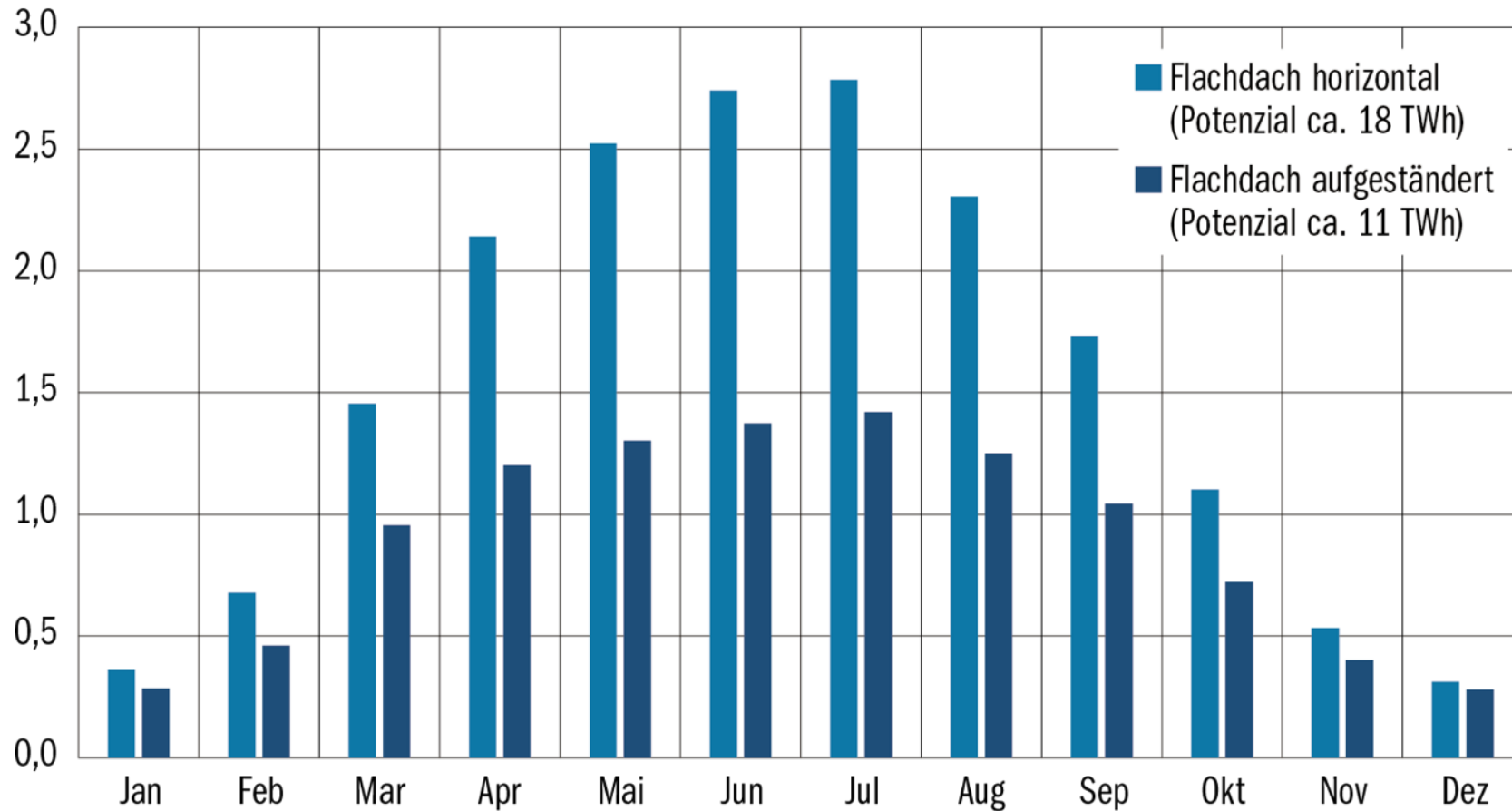

Quelle: Christof Bucher, Photovoltaikanlagen, Faktor Verlag 2021

Monatsertrag in TWh

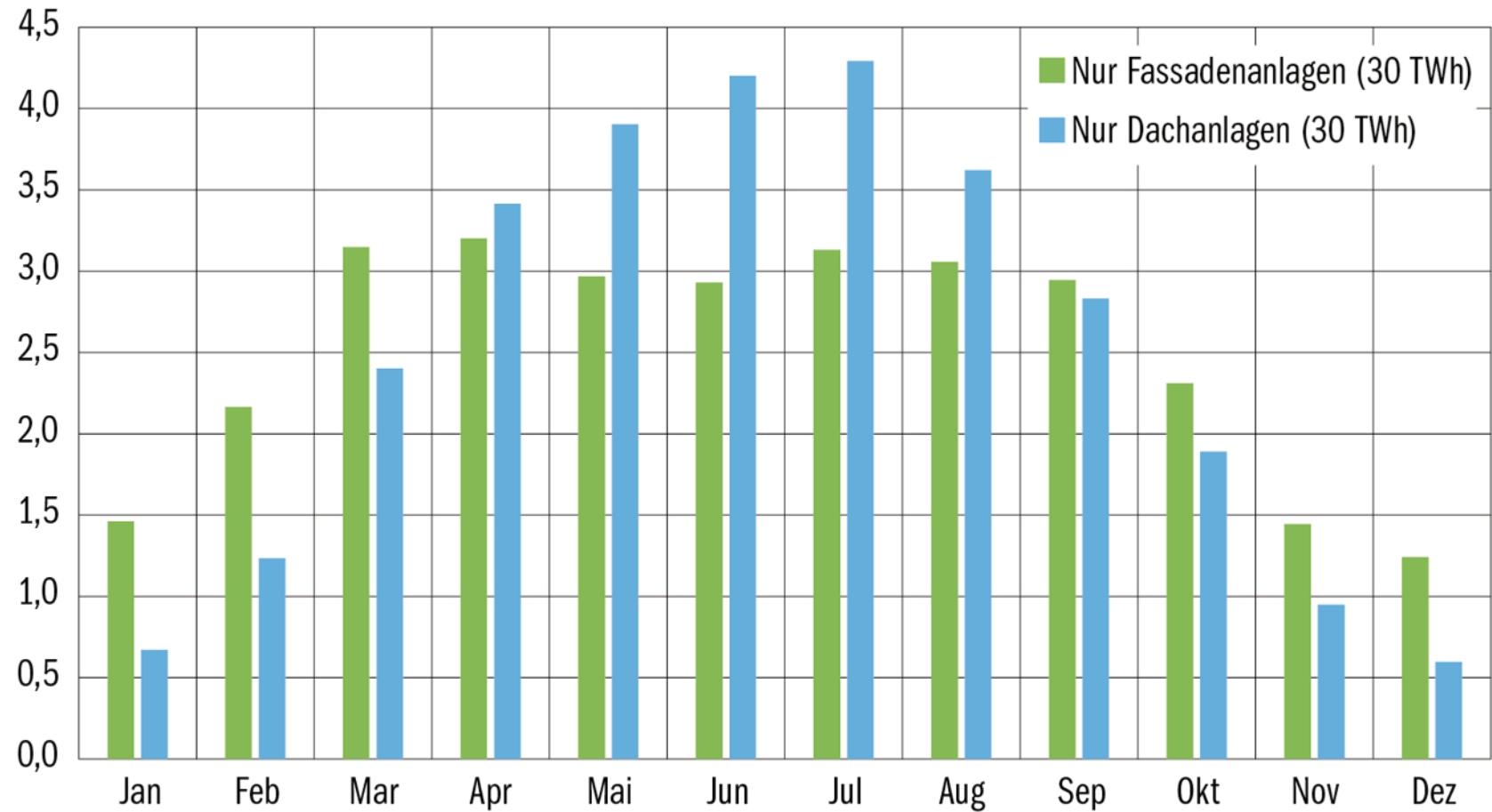

Quelle: Christof Bucher, Photovoltaikanlagen, Faktor Verlag 2021

Reduktion monatliche Lastspitze in % der PV-Leistung

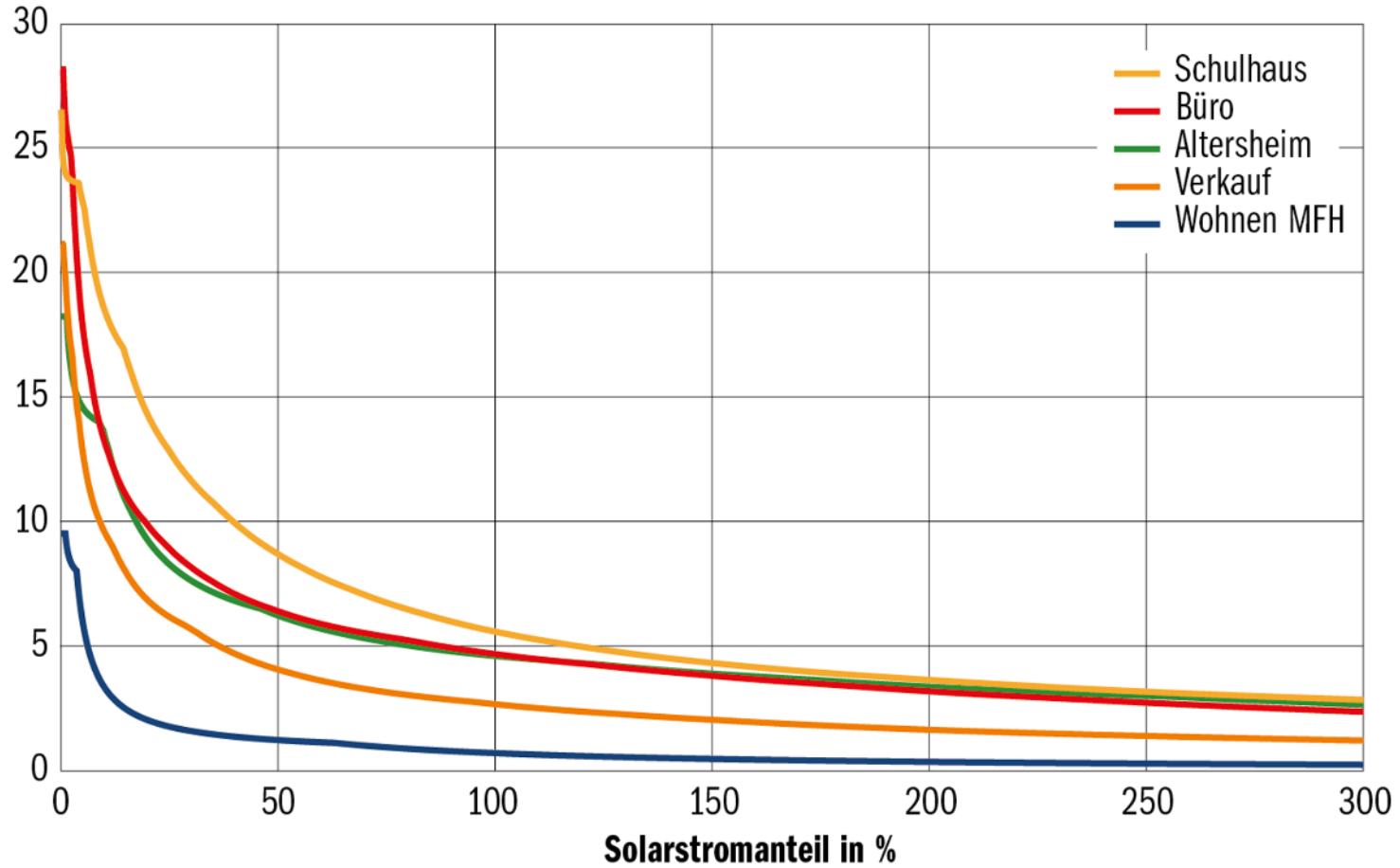

Quelle: Christof Bucher, Photovoltaikanlagen, Faktor Verlag 2021

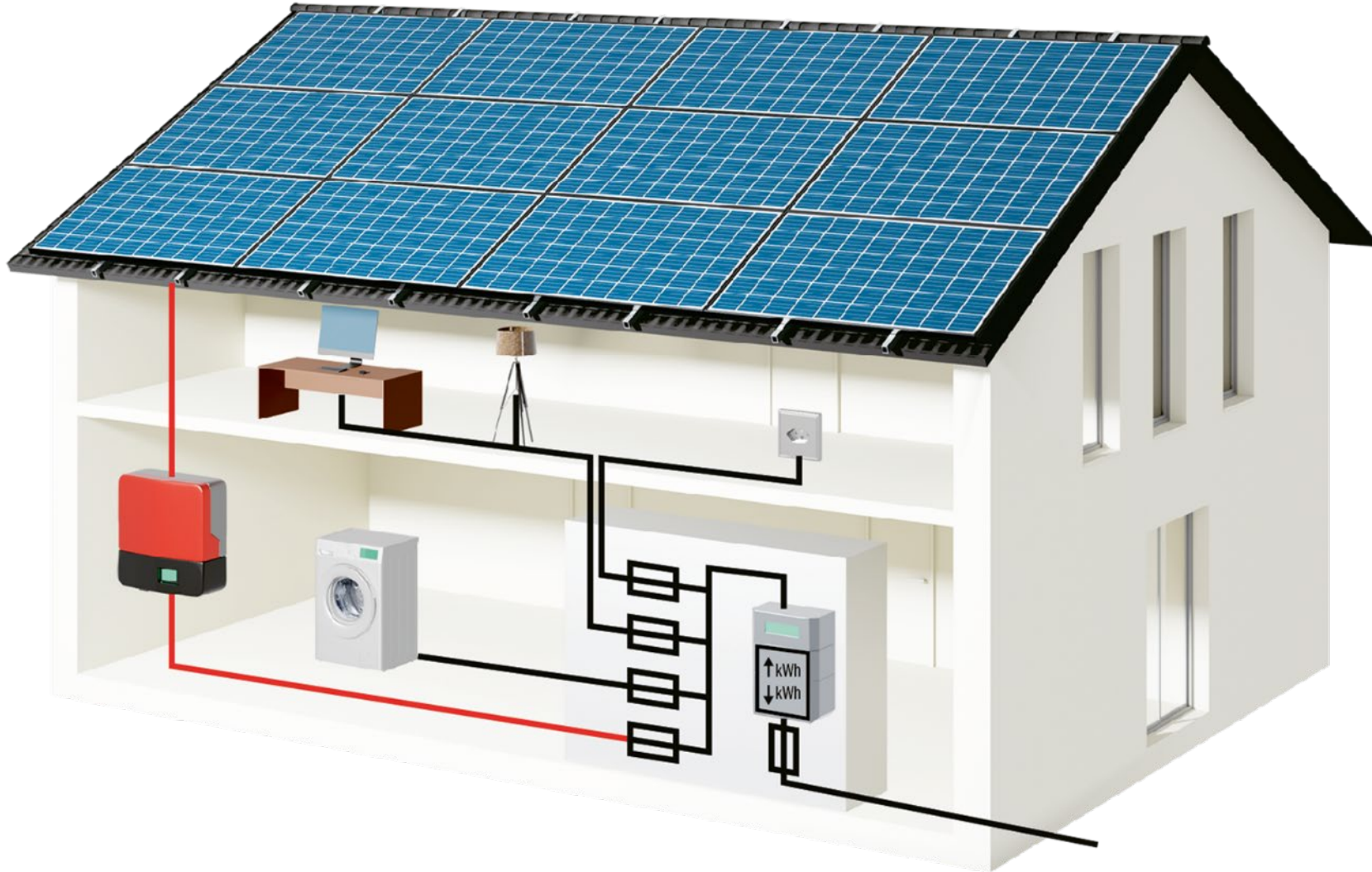

Quelle: Christof Bucher, Photovoltaikanlagen, Faktor Verlag 2021

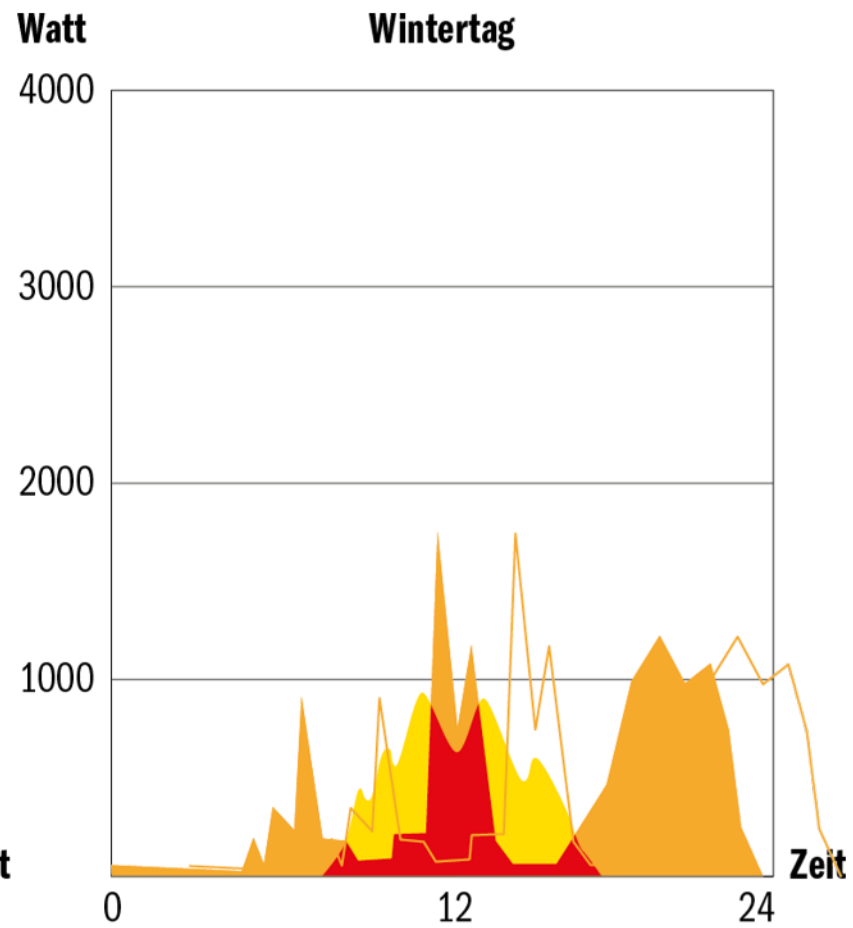
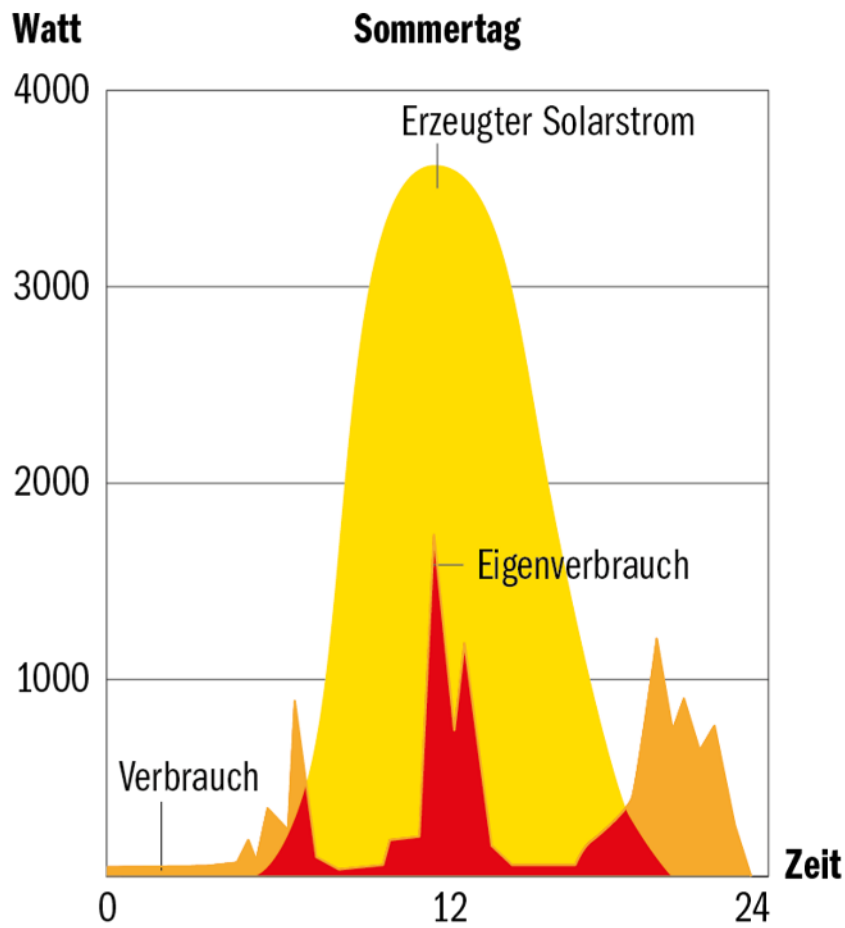

Quelle: Christof Bucher, Photovoltaikanlagen, Faktor Verlag 2021

Eigenverbrauchsanteil in %

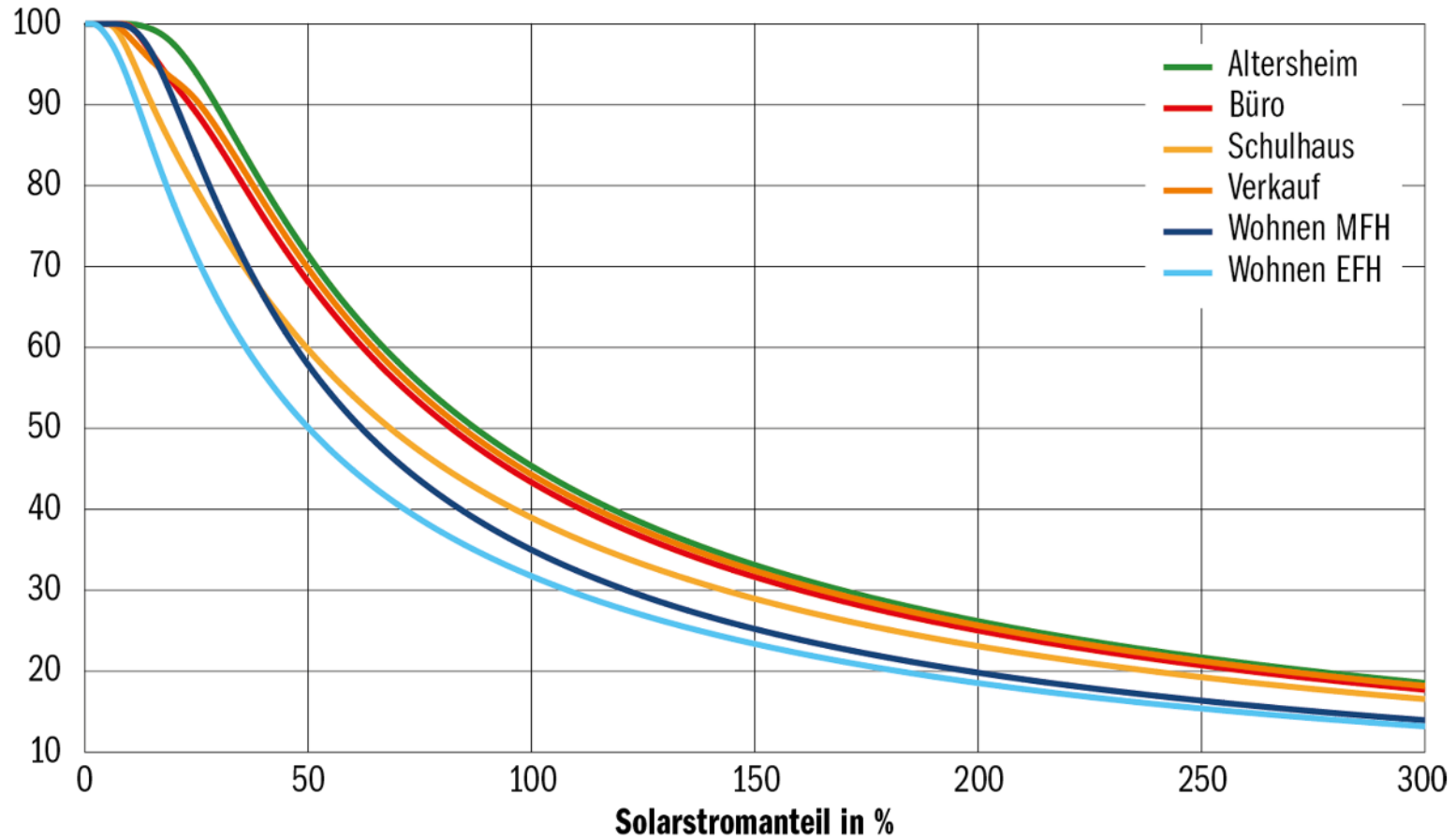

Quelle: Christof Bucher, Photovoltaikanlagen, Faktor Verlag 2021

Eigenverbrauchsanteil in %

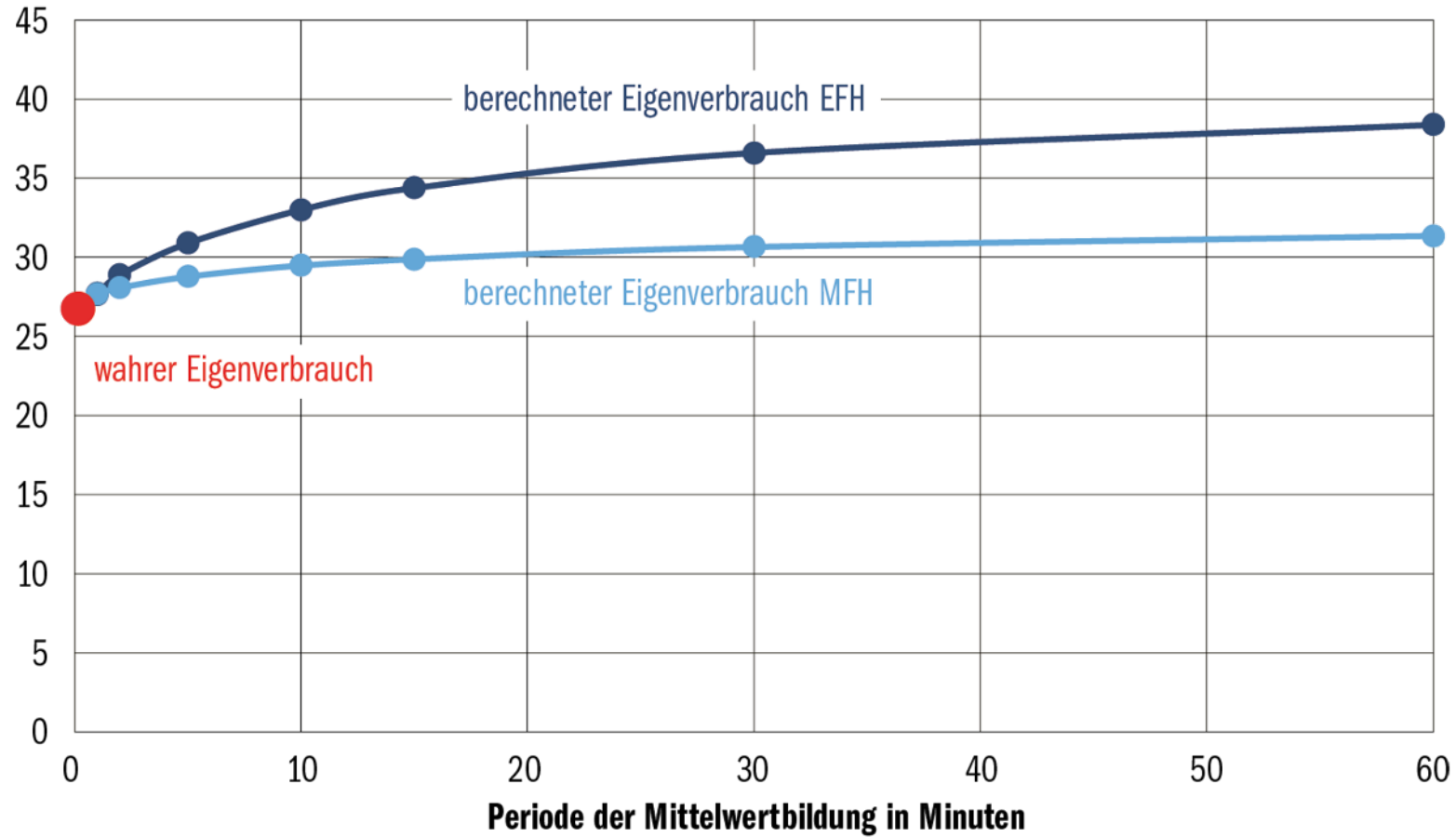

Quelle: Christof Bucher, Photovoltaikanlagen, Faktor Verlag 2021

Eigenverbrauch Haushalt 3000 kWh + Wassererwärmer 2000 kWh

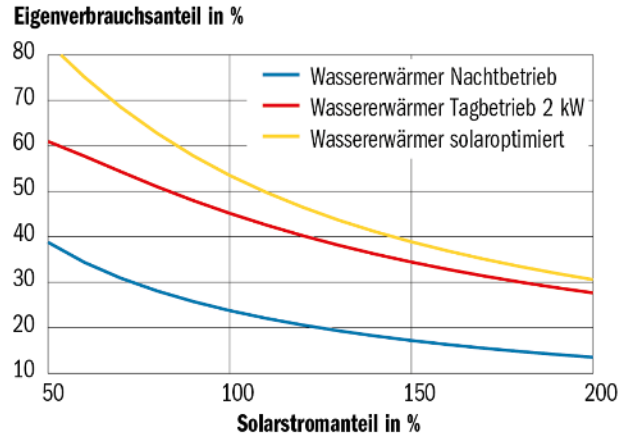

Eigenverbrauch Haushalt 3000 kWh + Wärmepumpe 3000 kWh (Raumwärme) + 1000 kWh (Warmwasser)

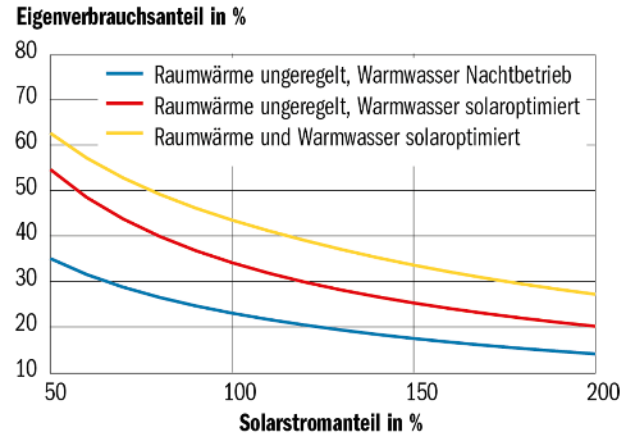

Eigenverbrauch verschiedene Modulausrichtungen (Haushalt 3000 kWh + WP 3000 kWh + 1000 kWh)

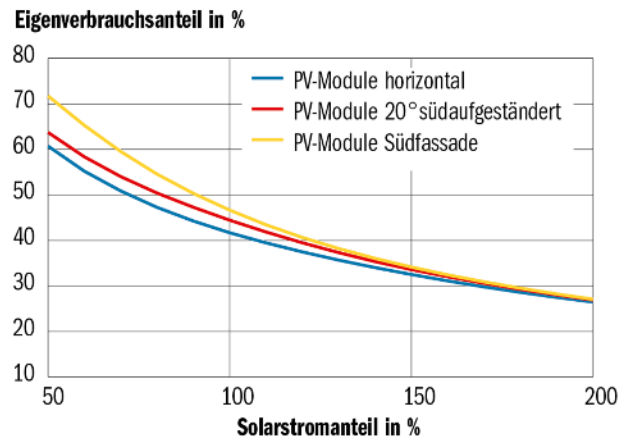

Eigenverbrauch Haushalt 3000 kWh + Elektrofahrzeug 2000 kWh

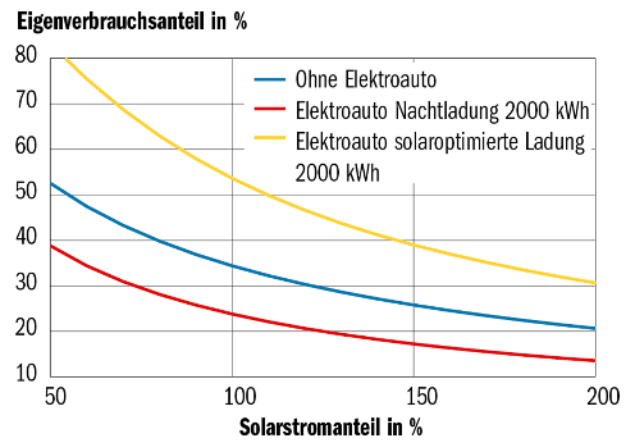

Quelle: Christof Bucher, Photovoltaikanlagen, Faktor Verlag 2021

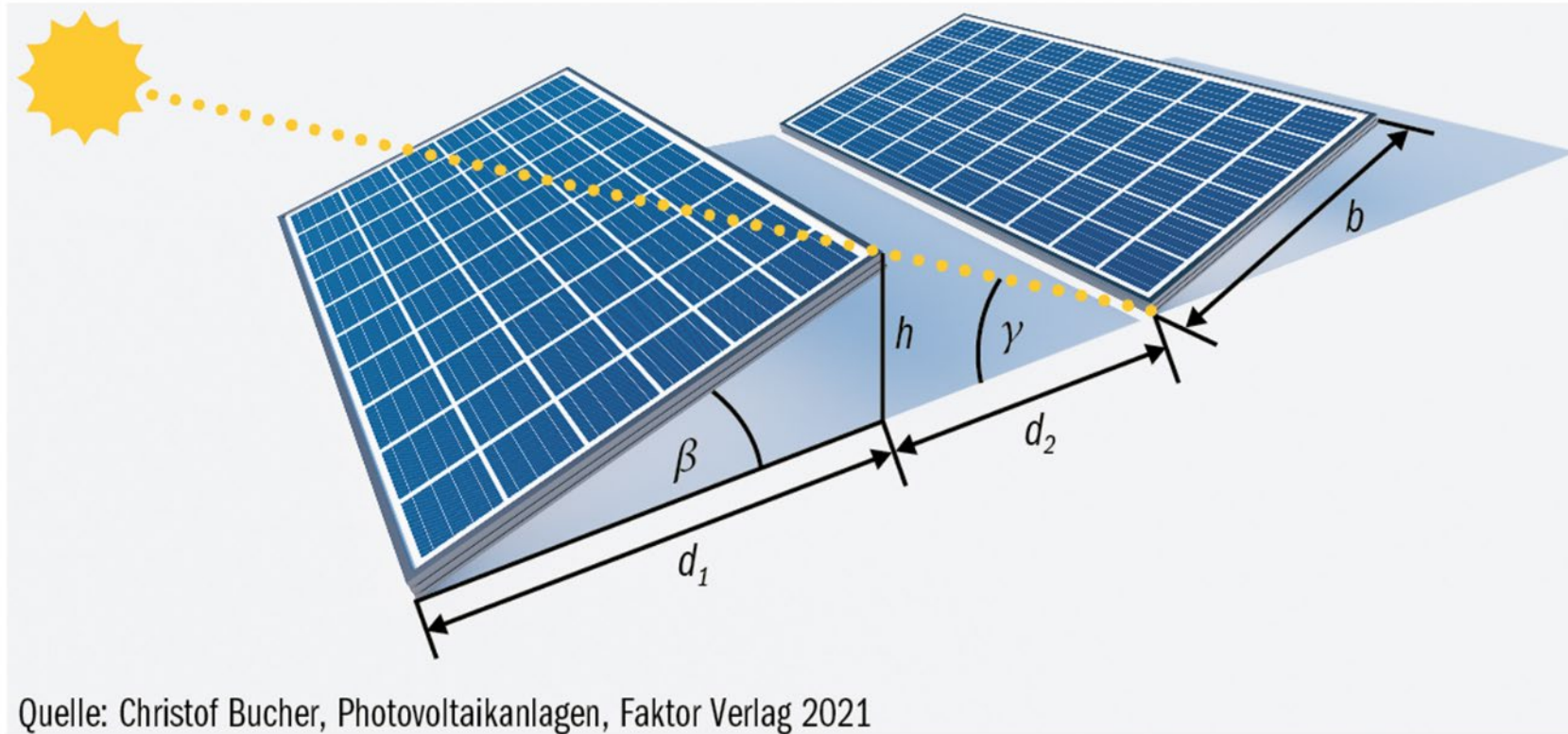

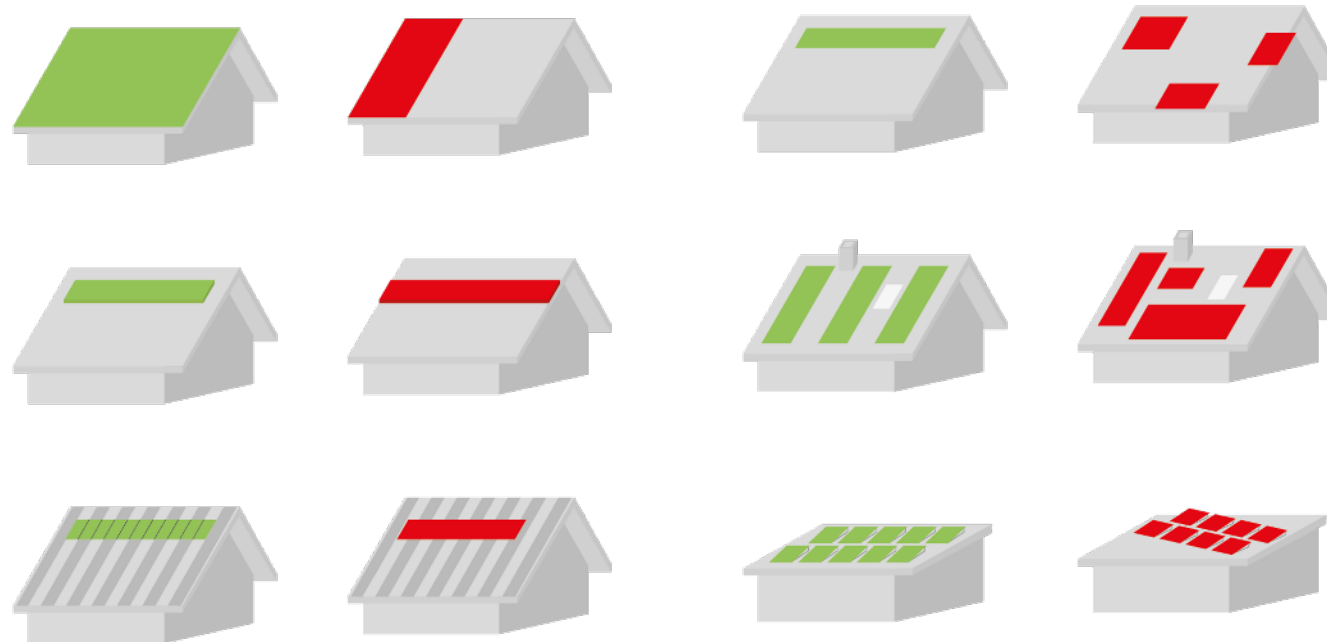

Quelle: Christof Bucher, Photovoltaikanlagen, Faktor Verlag 2021

Neigungswinkel in Grad

Nennleistungsverhältnis für 1% Ertragsverlust

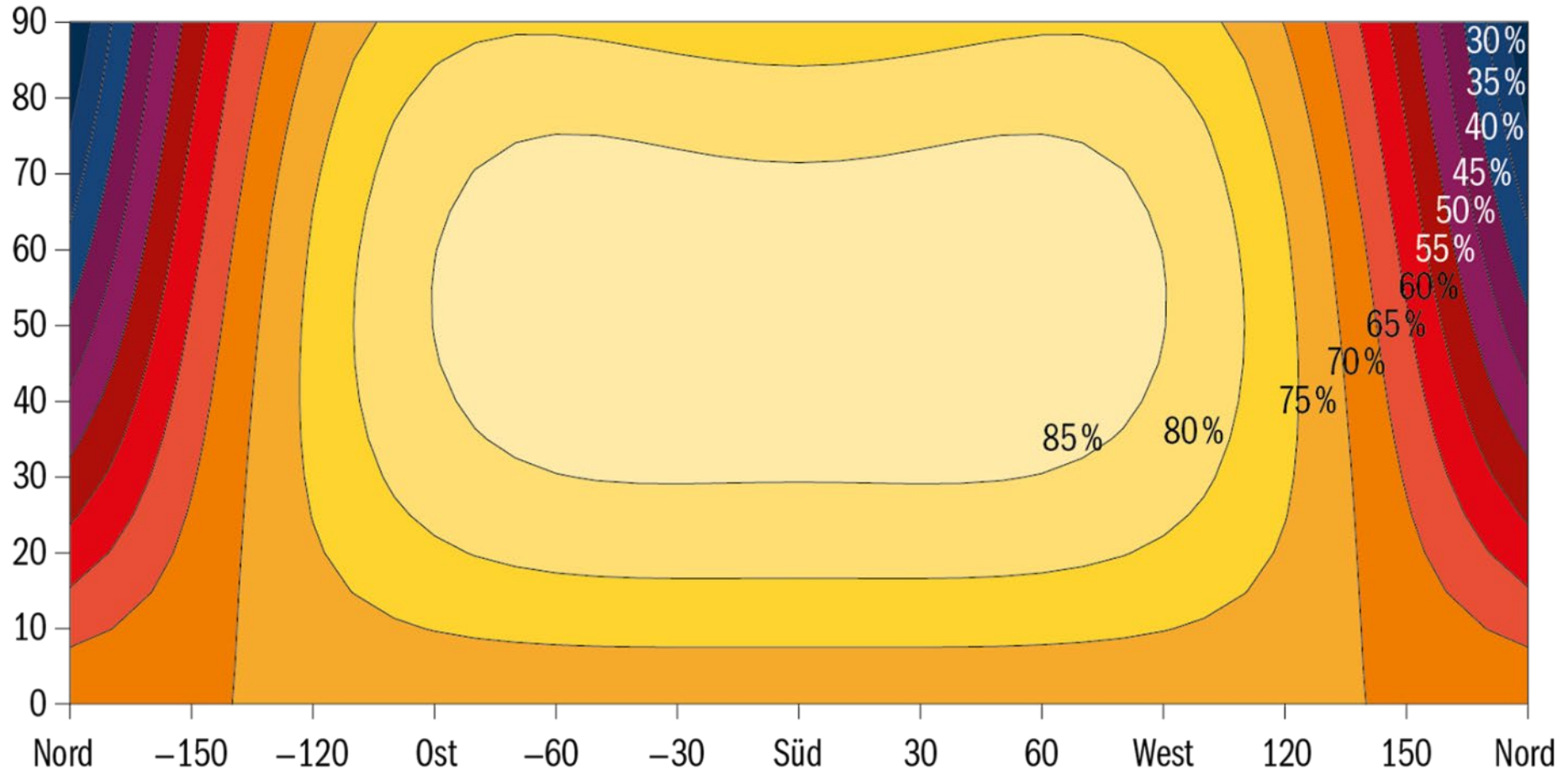

Neigungswinkel in Grad

Nennleistungsverhältnis für 3% Ertragsverlust

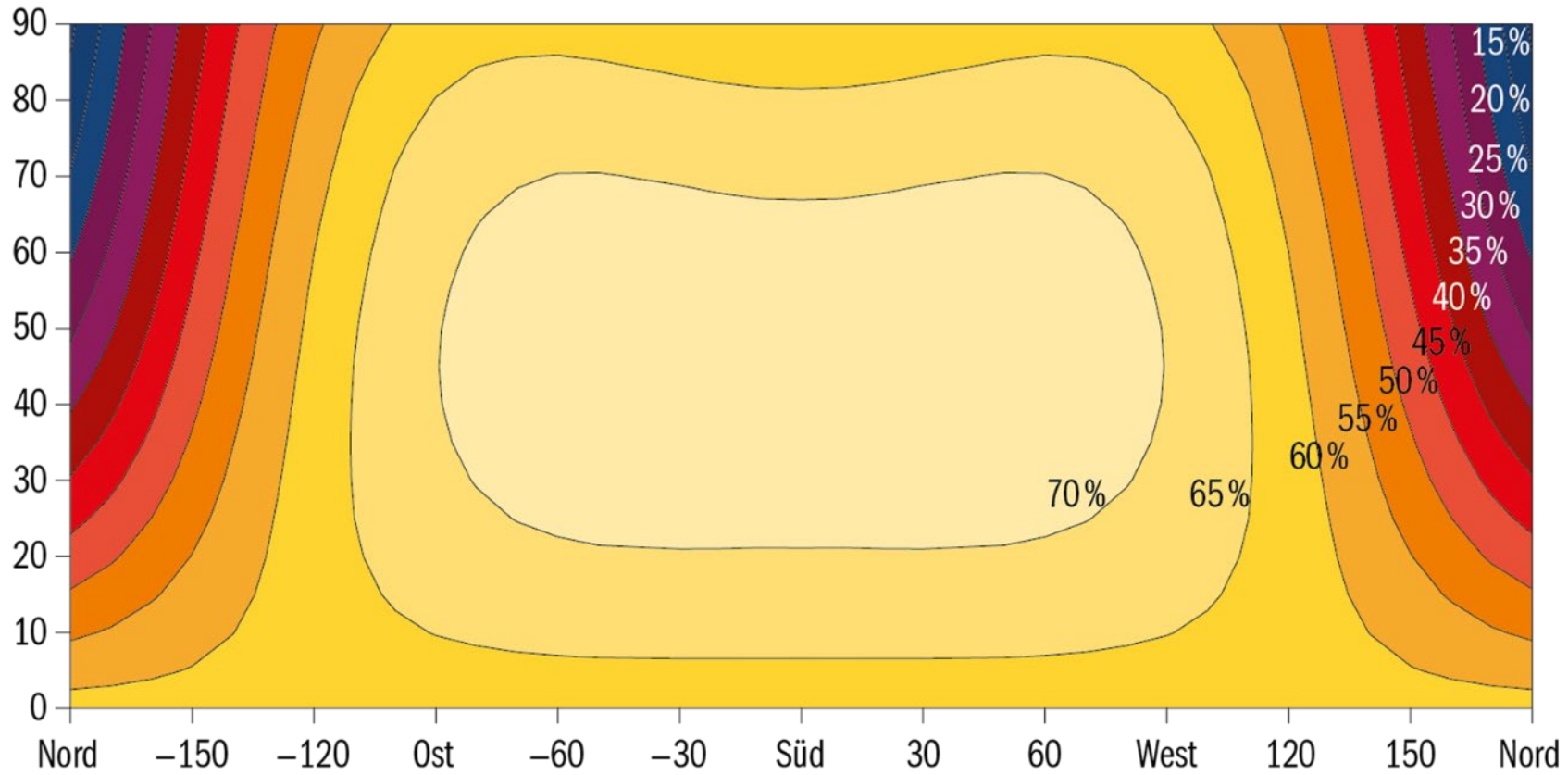

Quelle: Christof Bucher, Photovoltaikanlagen, Faktor Verlag 2021

Ertragsverlust in %

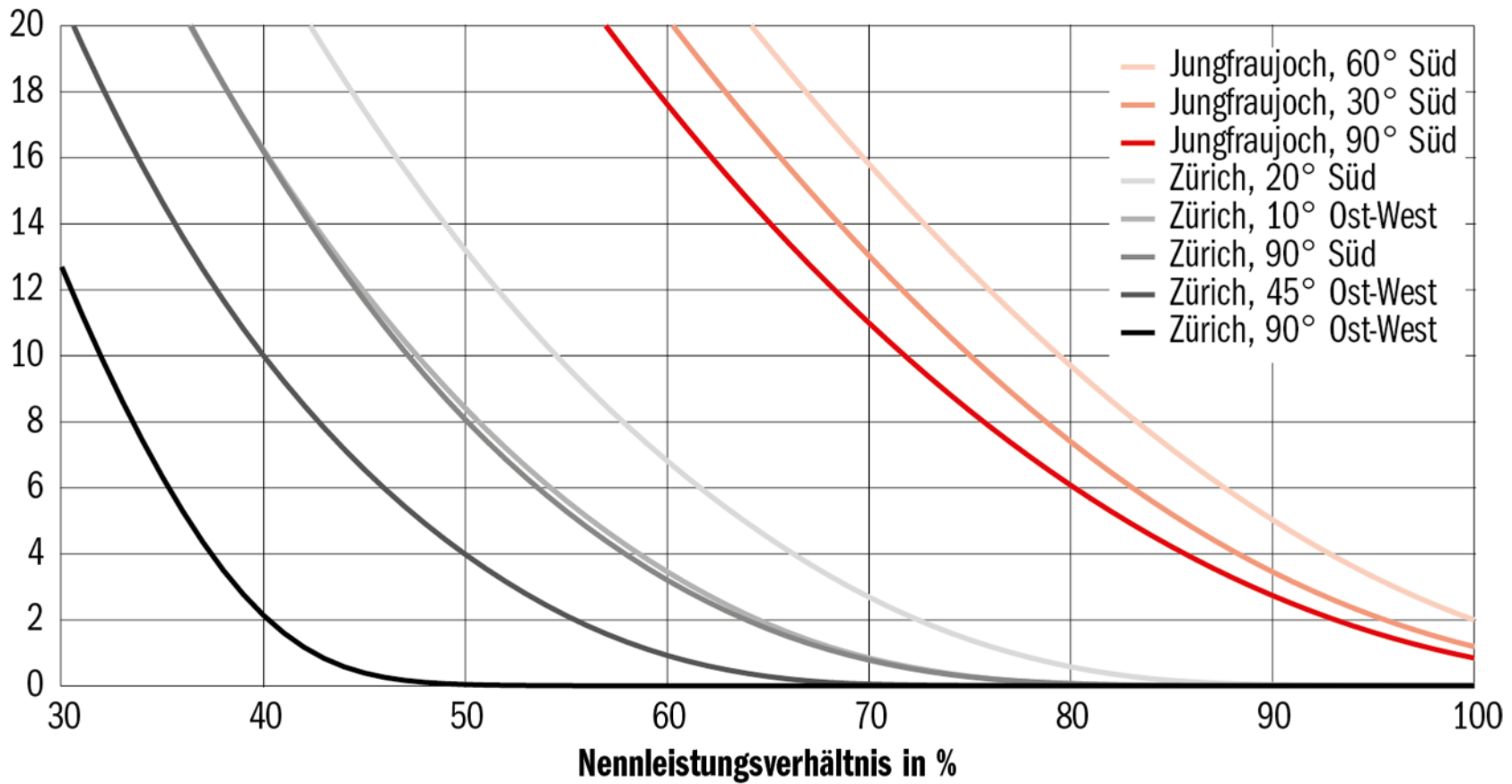

Quelle: Christof Bucher, Photovoltaikanlagen, Faktor Verlag 2021

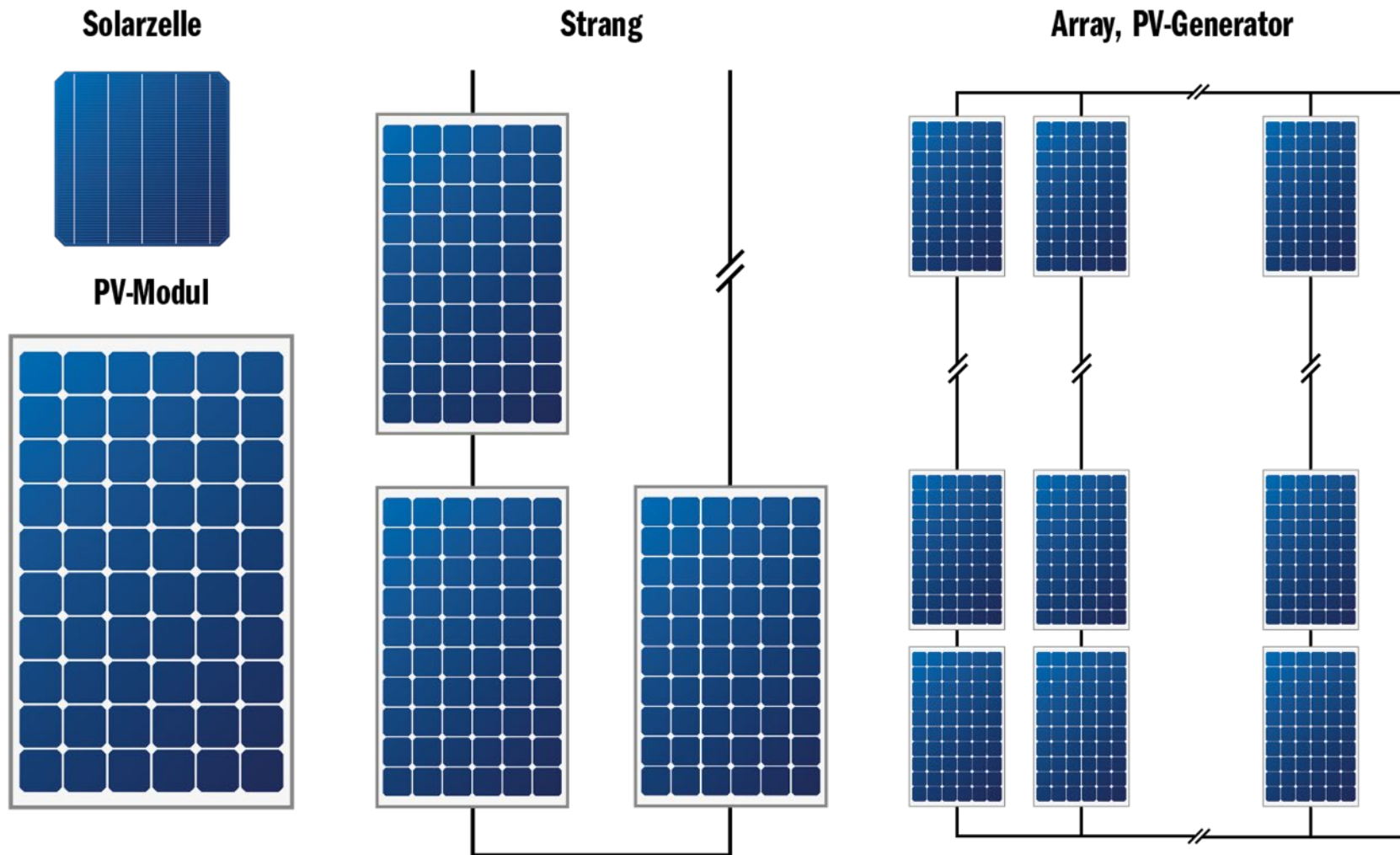

Quelle: Christof Bucher, Photovoltaikanlagen, Faktor Verlag 2021

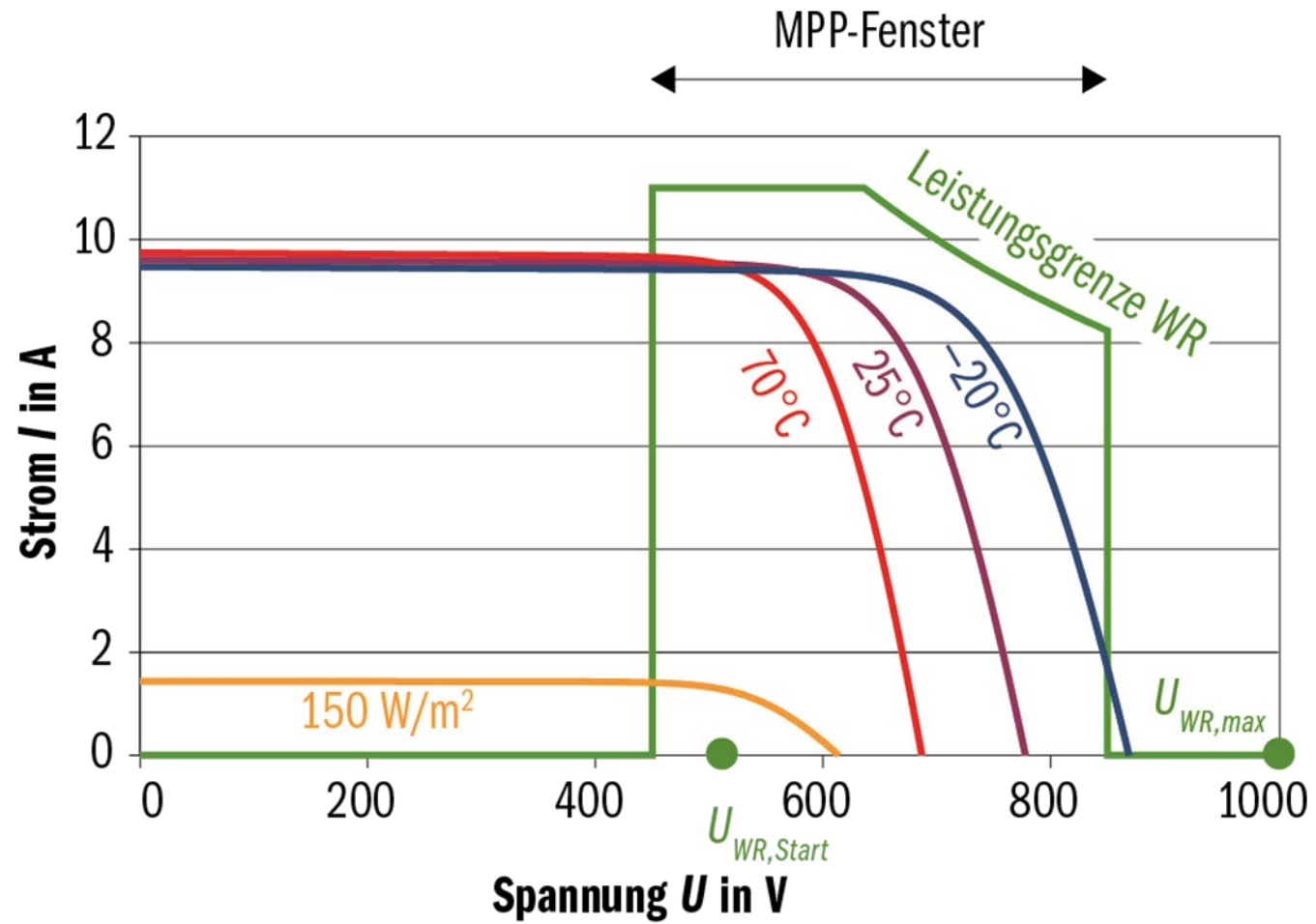

Quelle: Christof Bucher, Photovoltaikanlagen, Faktor Verlag 2021

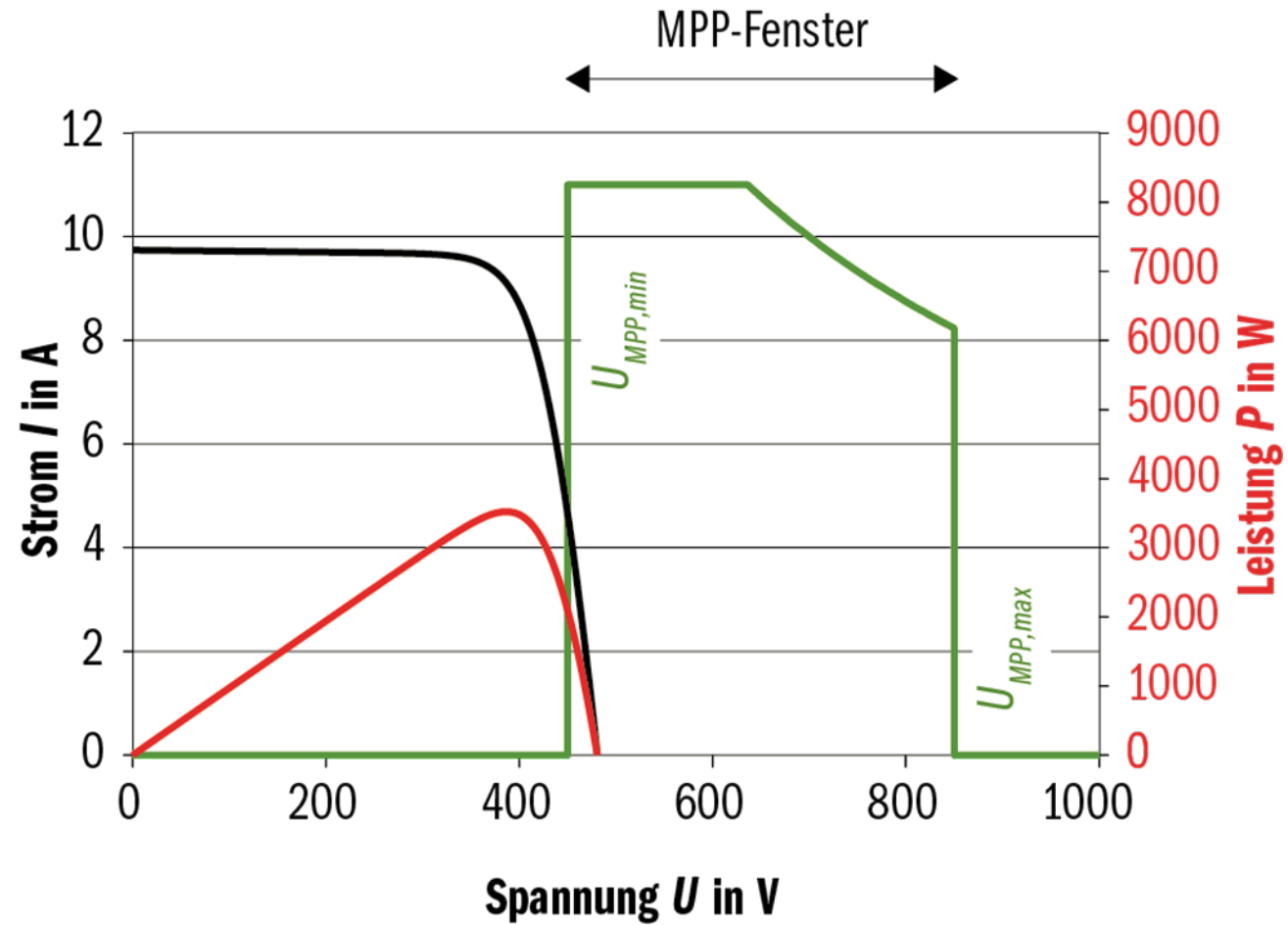

Quelle: Christof Bucher, Photovoltaikanlagen, Faktor Verlag 2021

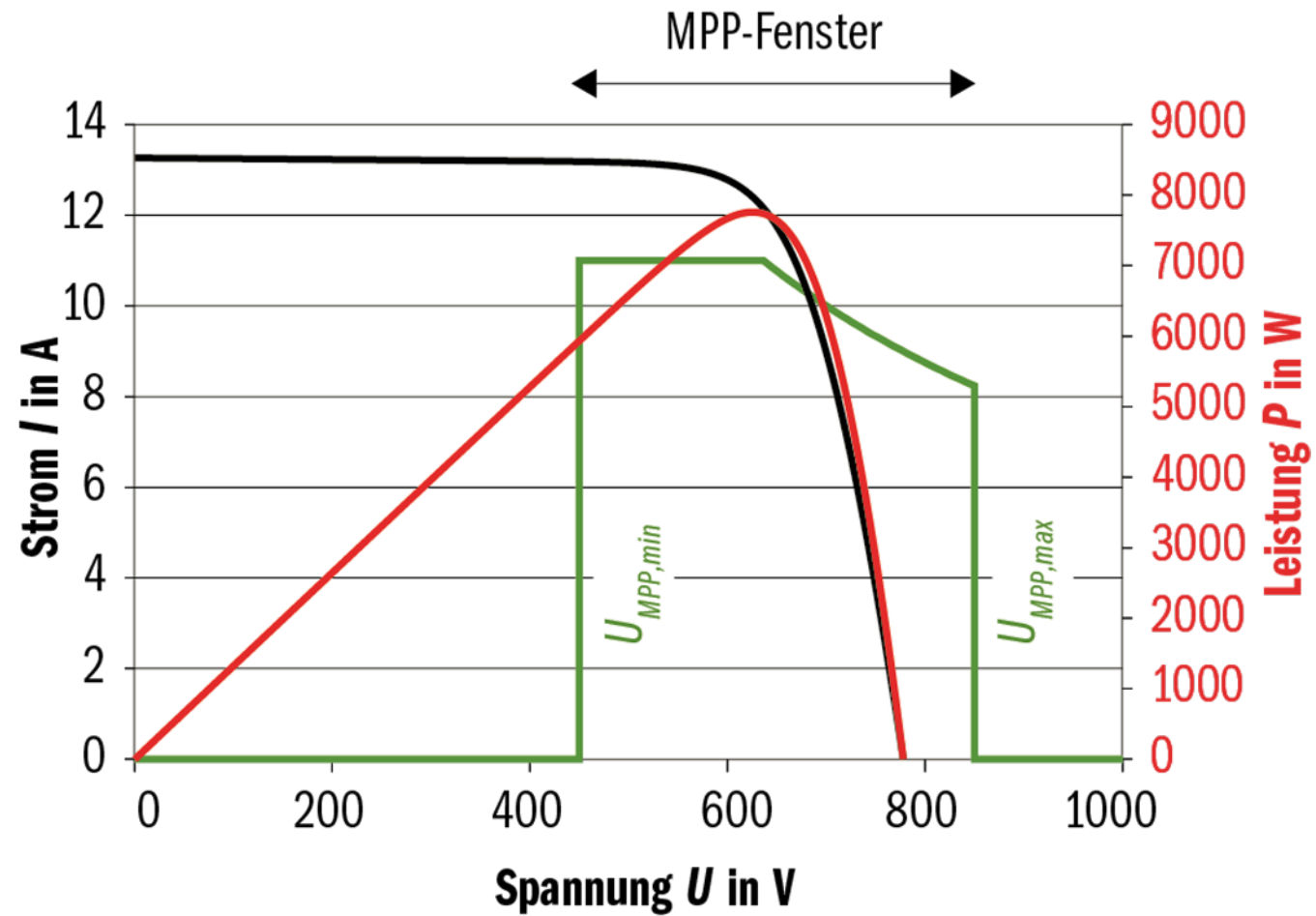

Quelle: Christof Bucher, Photovoltaikanlagen, Faktor Verlag 2021

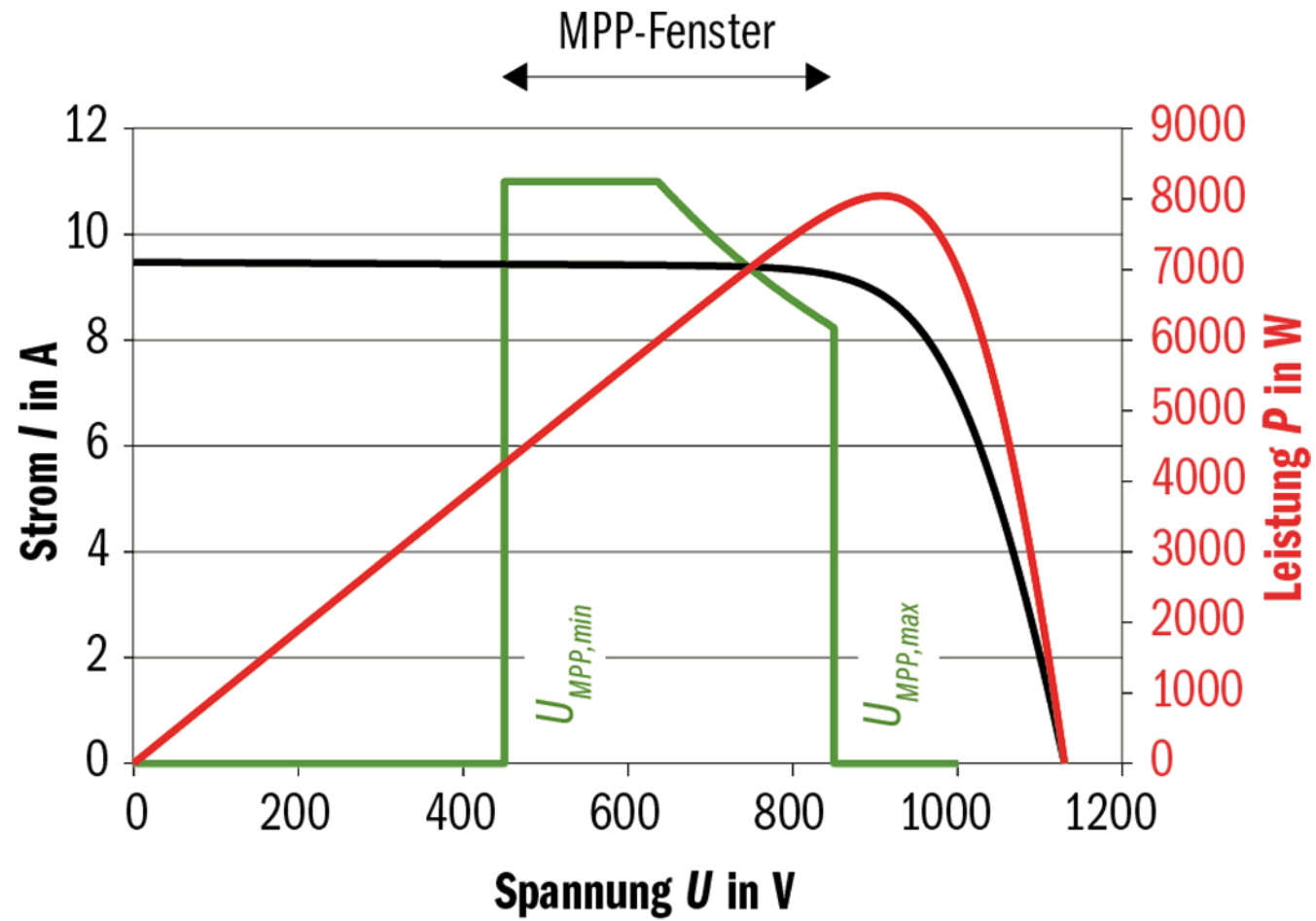

Quelle: Christof Bucher, Photovoltaikanlagen, Faktor Verlag 2021

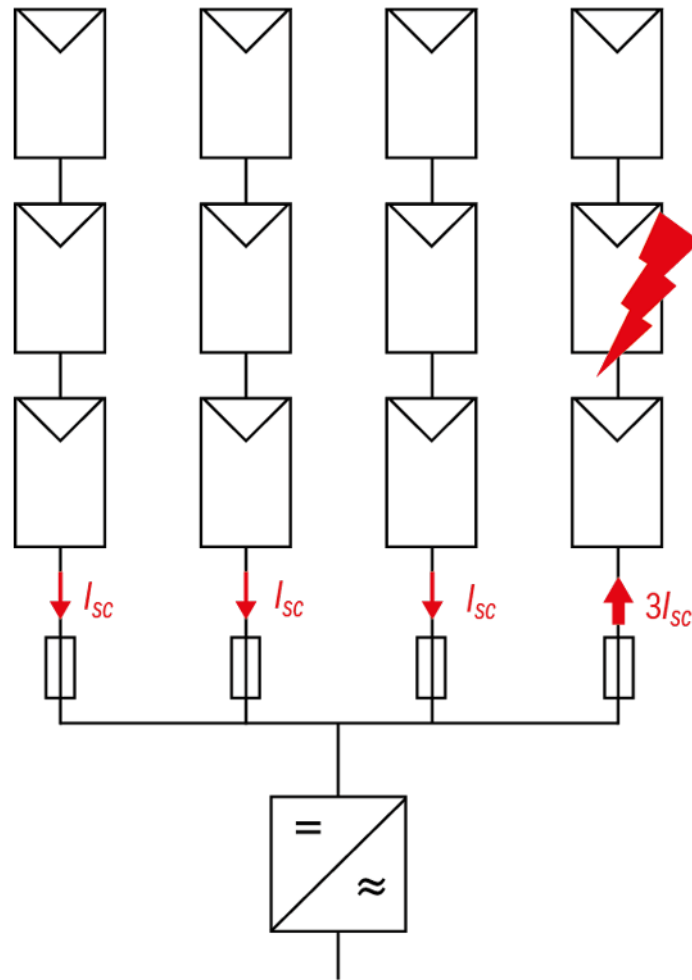

Quelle: Christof Bucher, Photovoltaikanlagen, Faktor Verlag 2021

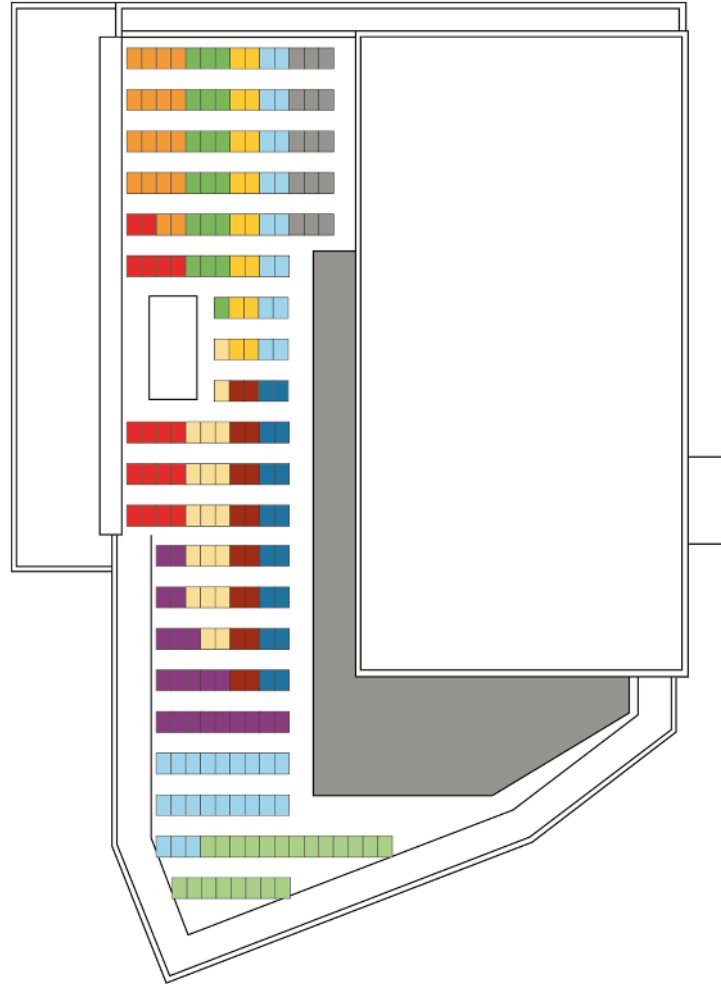

Quelle: Christof Bucher, Photovoltaikanlagen, Faktor Verlag 2021

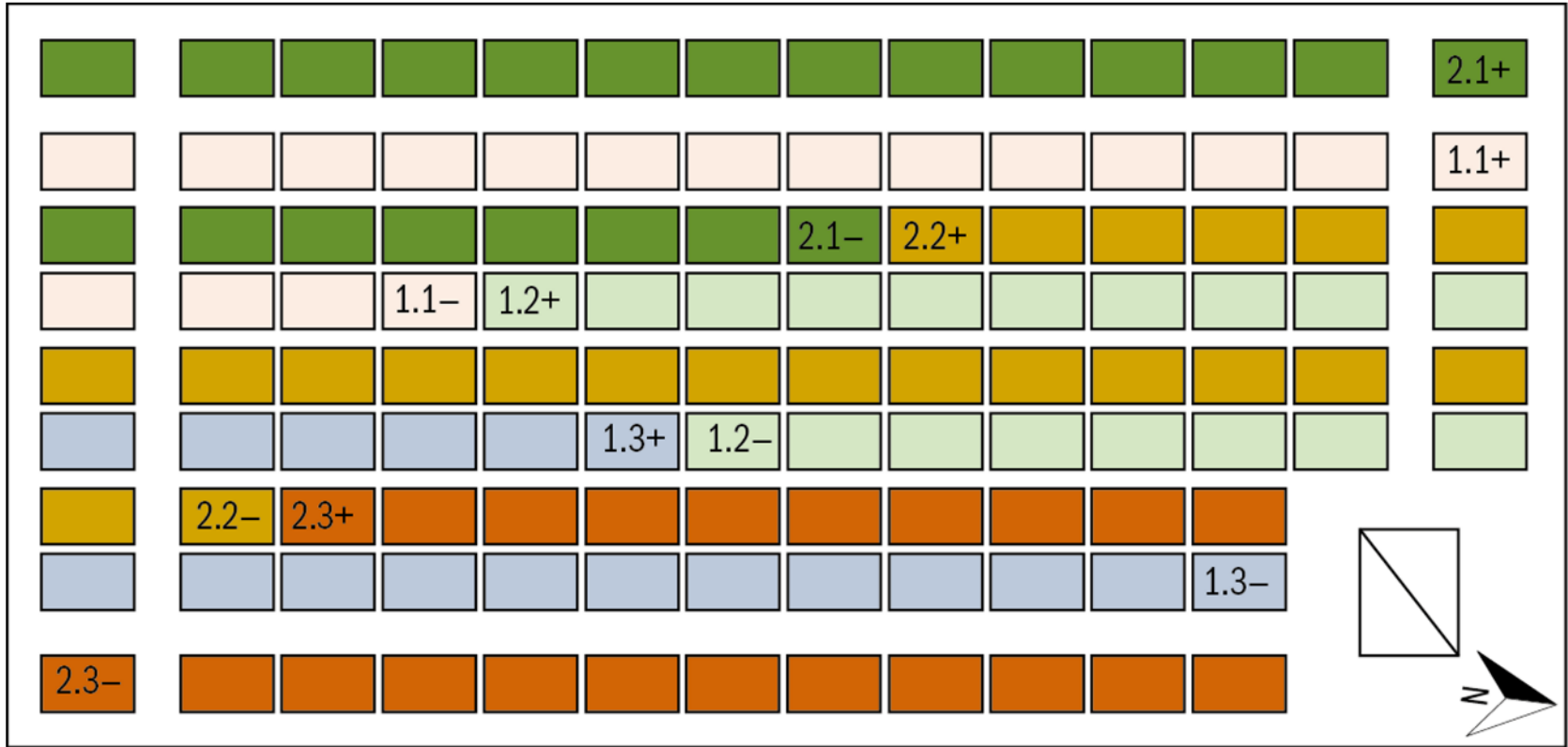

Quelle: Christof Bucher, Photovoltaikanlagen, Faktor Verlag 2021

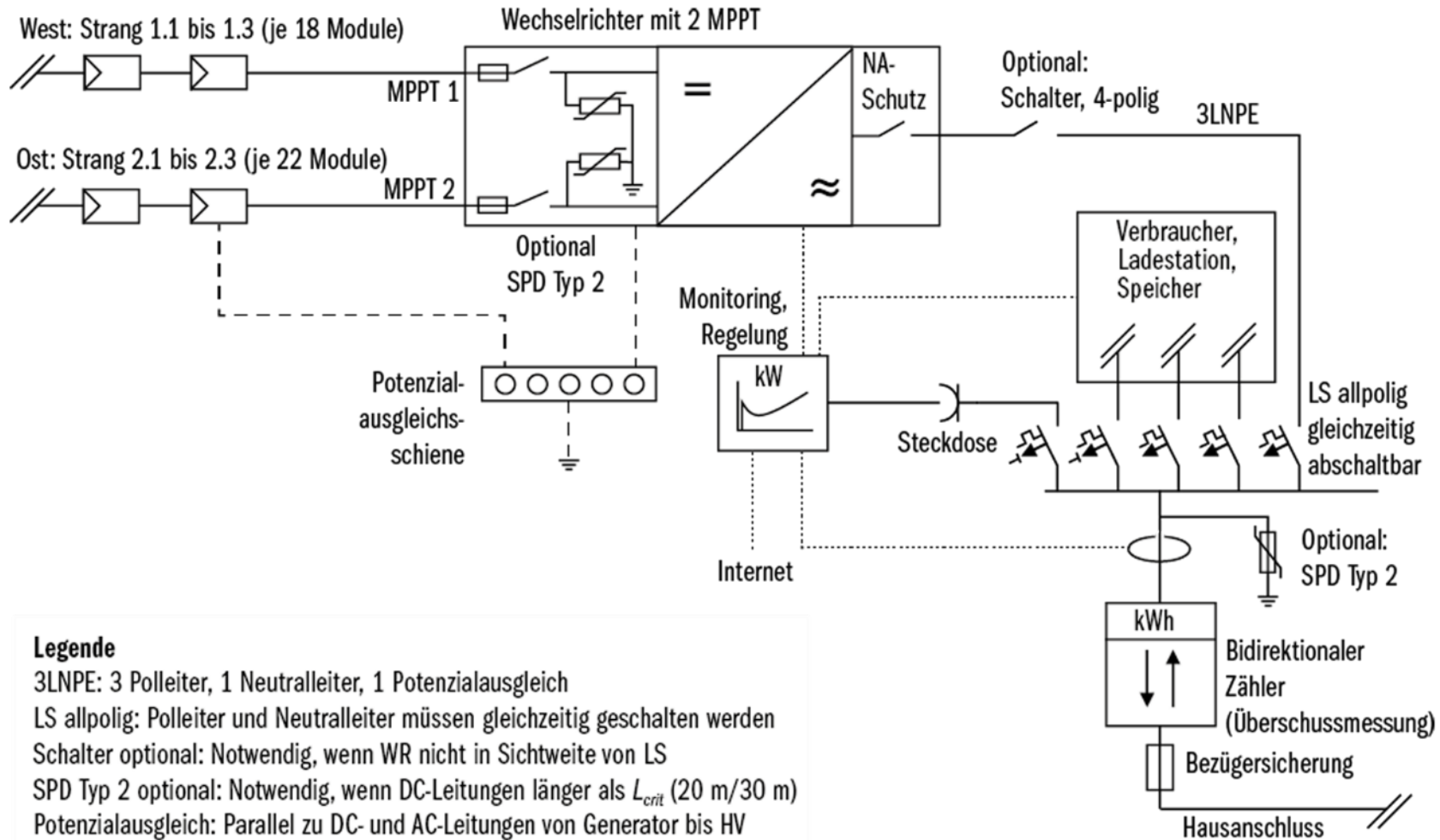

Legende

3LNPE: 3 Polleiter, 1 Neutralleiter, 1 Potenzialausgleich

LS allpolig: Polleiter und Neutralleiter müssen gleichzeitig geschaltet werden

Schalter optional: Notwendig, wenn WR nicht in Sichtweite von LS

SPD Typ 2 optional: Notwendig, wenn DC-Leitungen länger als L_{crit} (20 m/30 m)

Potenzialausgleich: Parallel zu DC- und AC-Leitungen von Generator bis HV

Quelle: Christof Bucher, Photovoltaikanlagen, Faktor Verlag 2021

12-V- oder 24-V-DC-Inselanlage mit einem einfachen Laderegler und einem Wechselrichter mit Steckdose

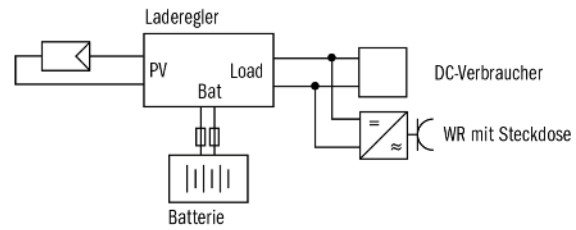

230-V-AC-Inselanlage mit einem PV-Inselschneider

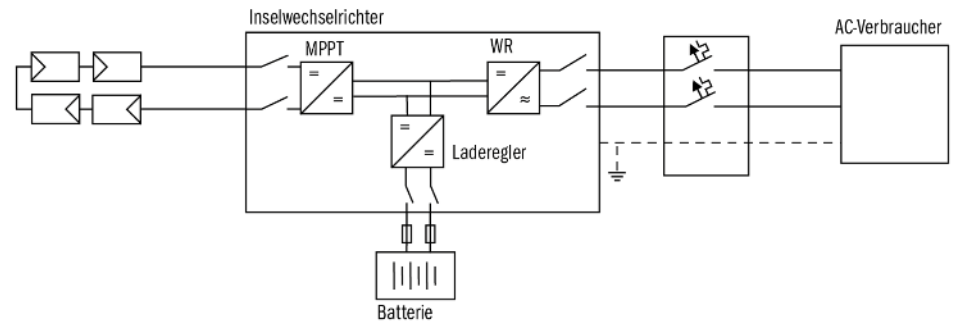

Modulare Inselanlage mit MPPT-Laderegler und separatem Sinuswechselrichter

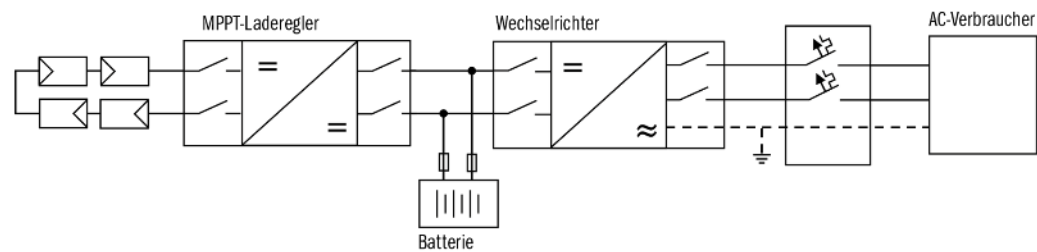

Quelle: Christof Bucher, Photovoltaikanlagen, Faktor Verlag 2021

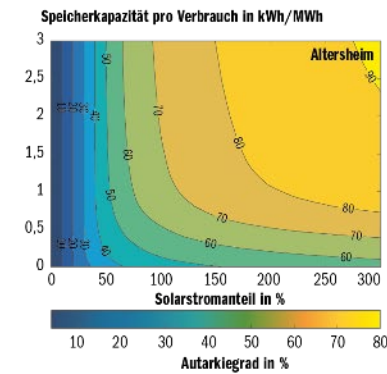
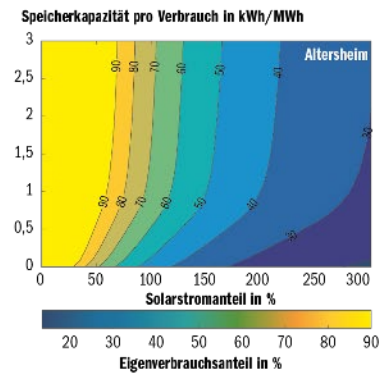
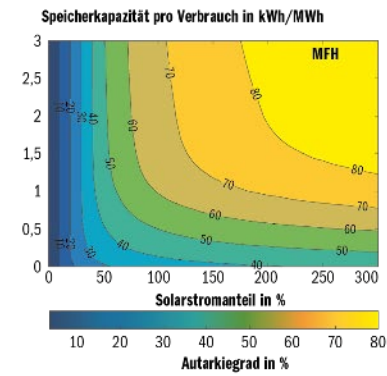
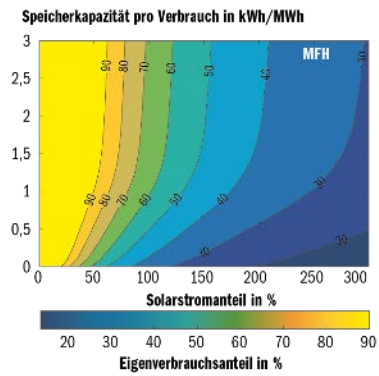
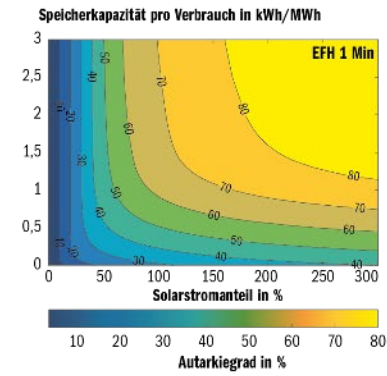
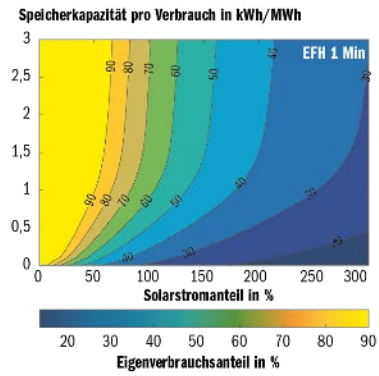

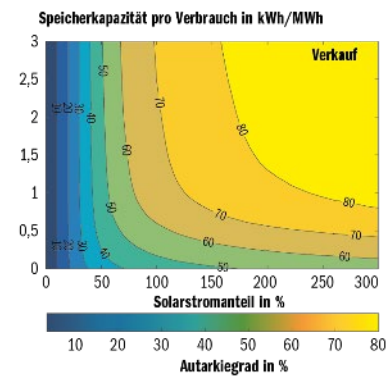
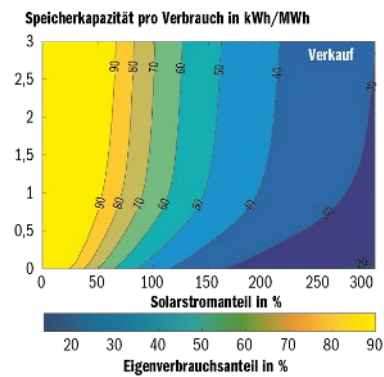
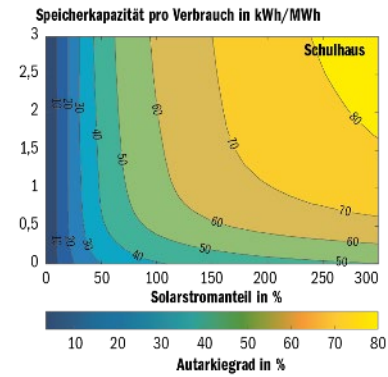
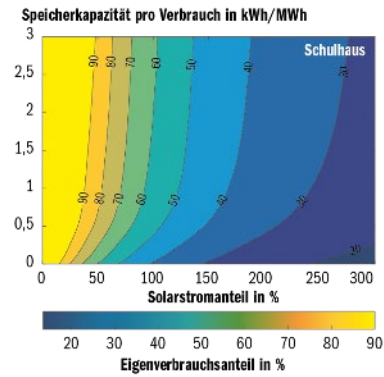
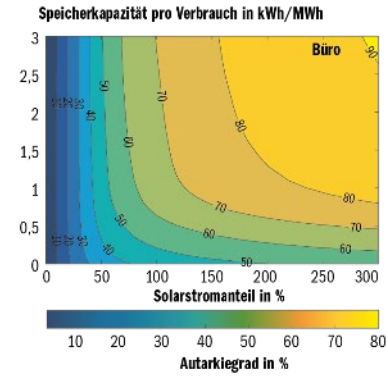
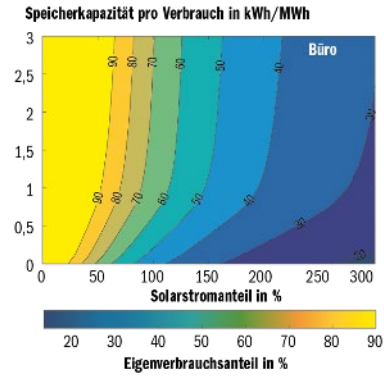

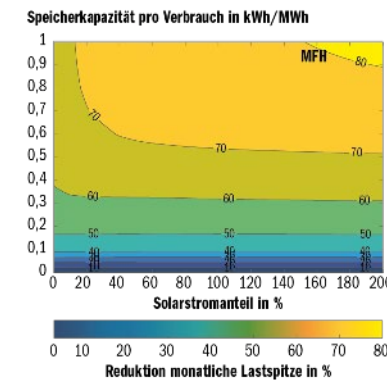
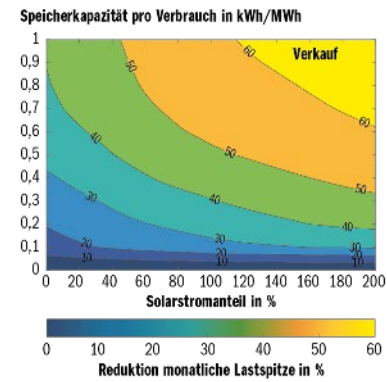
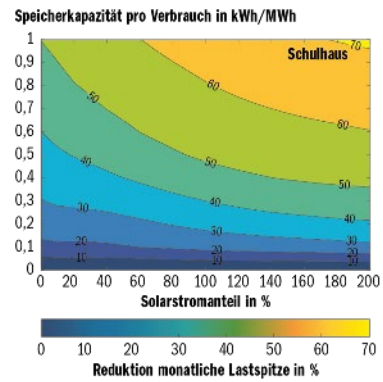
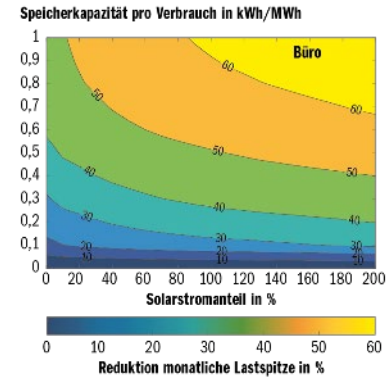
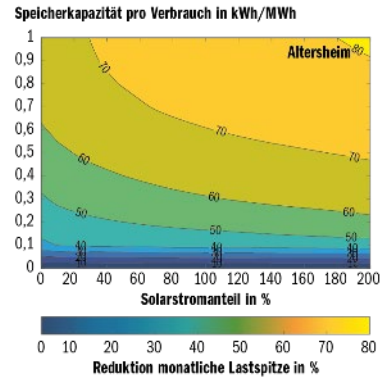

Leistung in kW

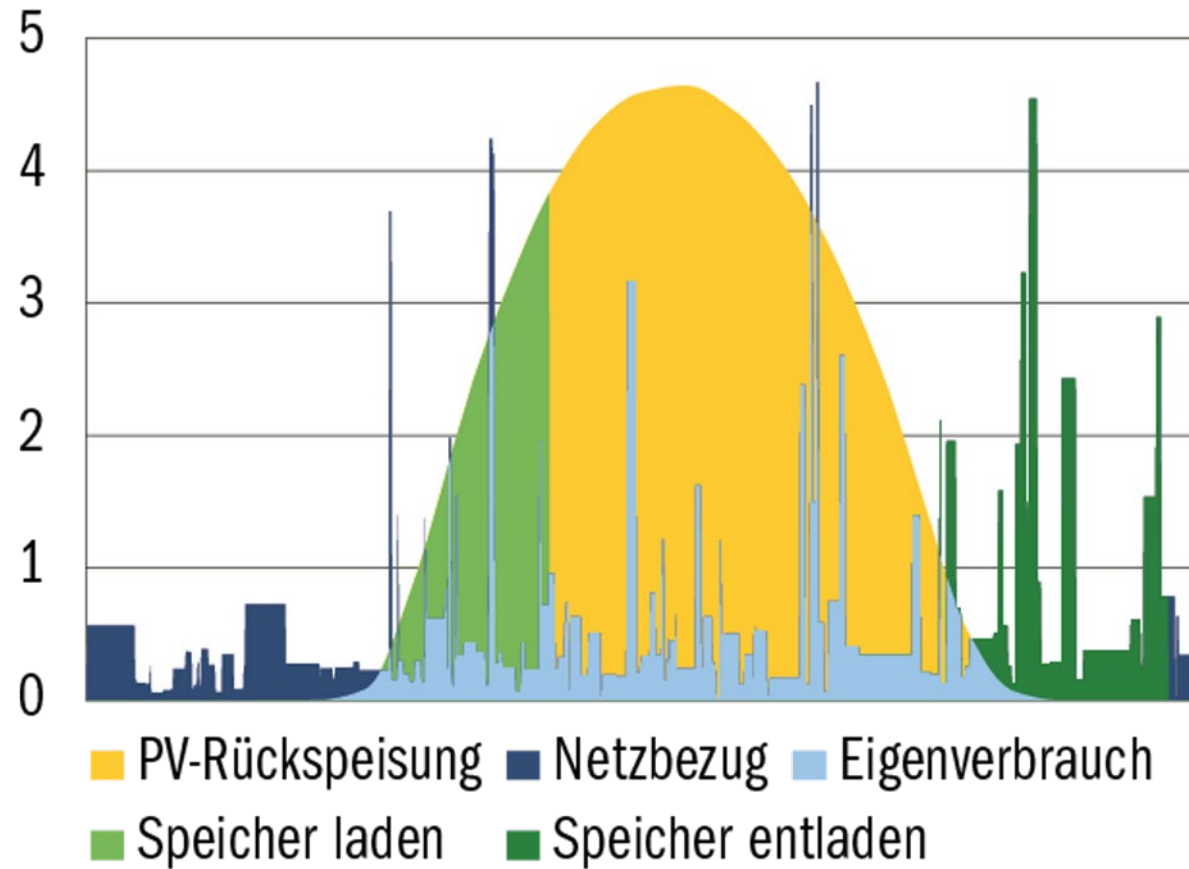

Quelle: Christof Bucher, Photovoltaikanlagen, Faktor Verlag 2021

Leistung in kW

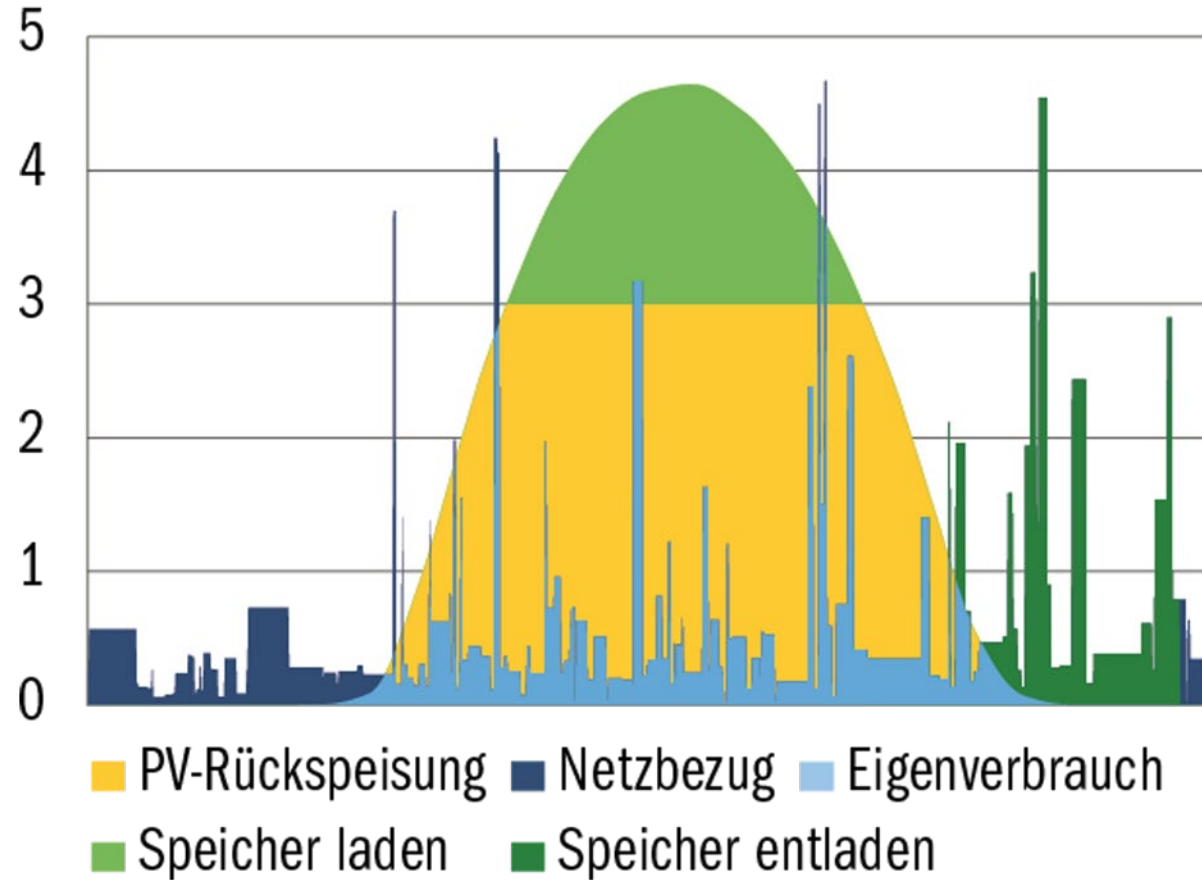

Quelle: Christof Bucher, Photovoltaikanlagen, Faktor Verlag 2021

Leistung in kW

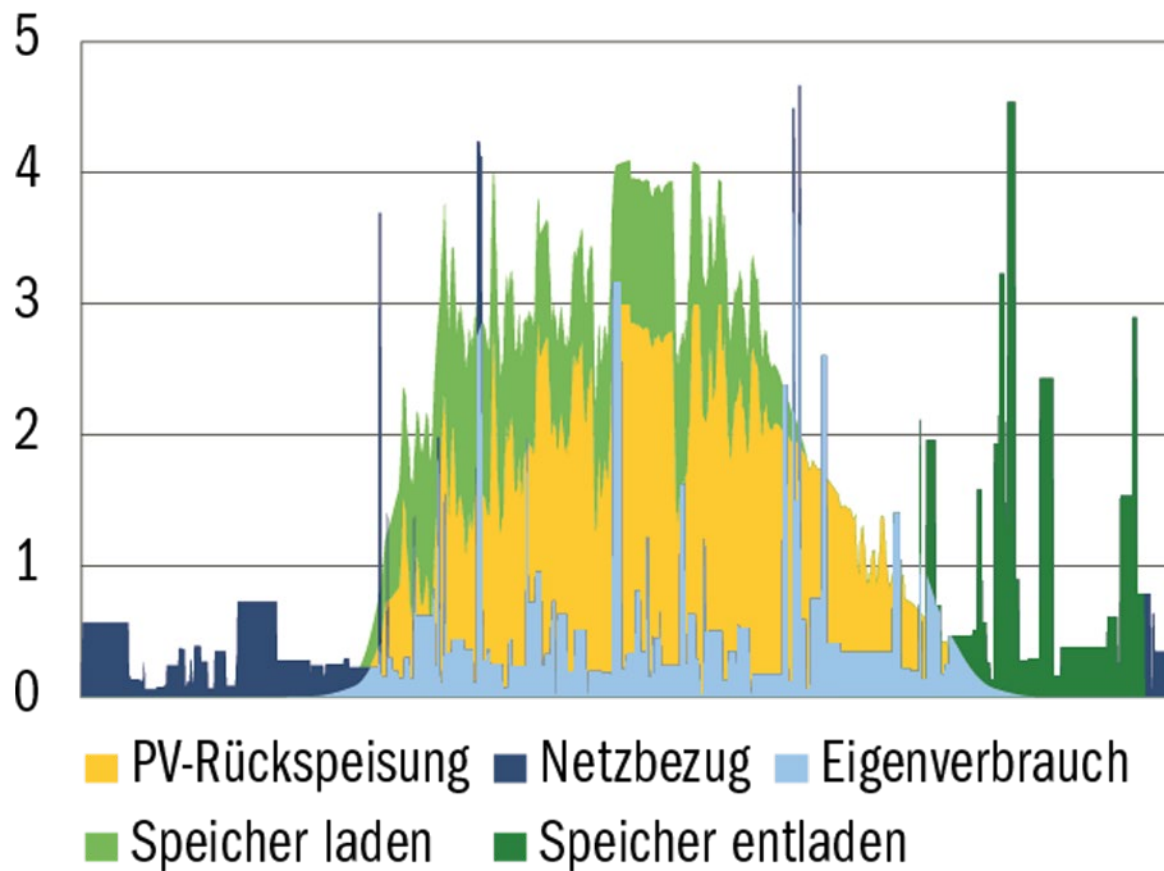

Quelle: Christof Bucher, Photovoltaikanlagen, Faktor Verlag 2021

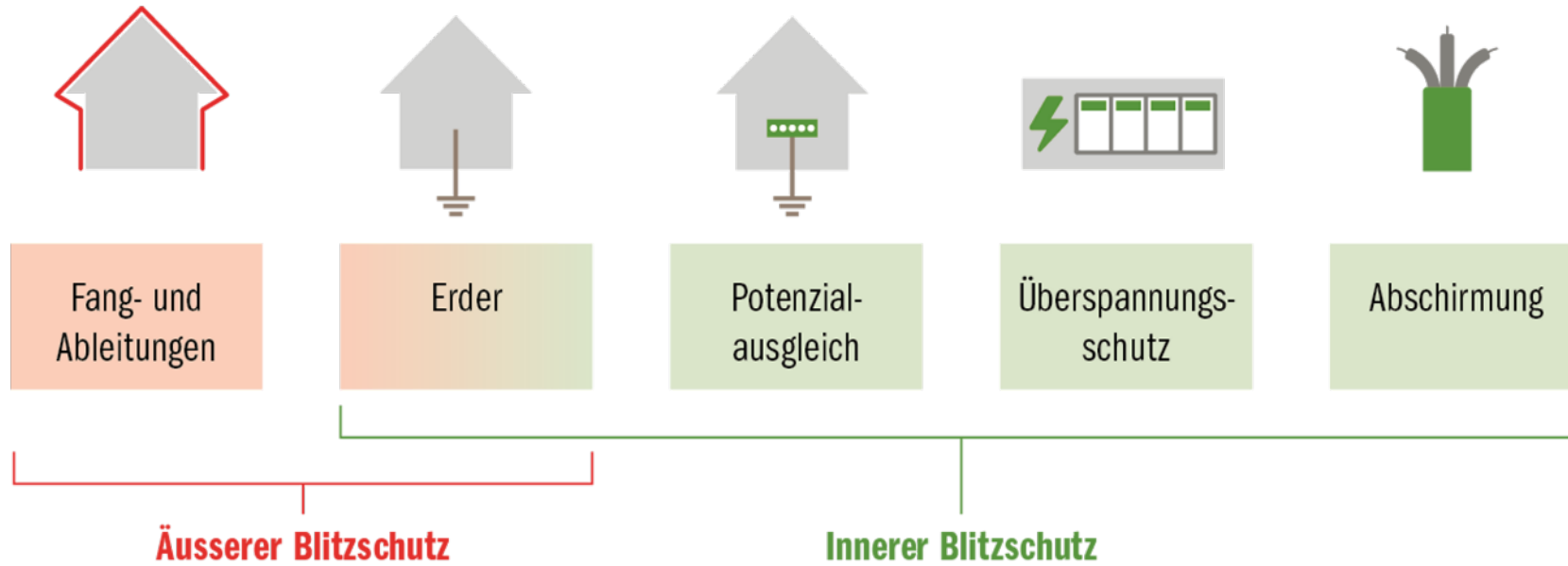

Quelle: Christof Bucher, Photovoltaikanlagen, Faktor Verlag 2021

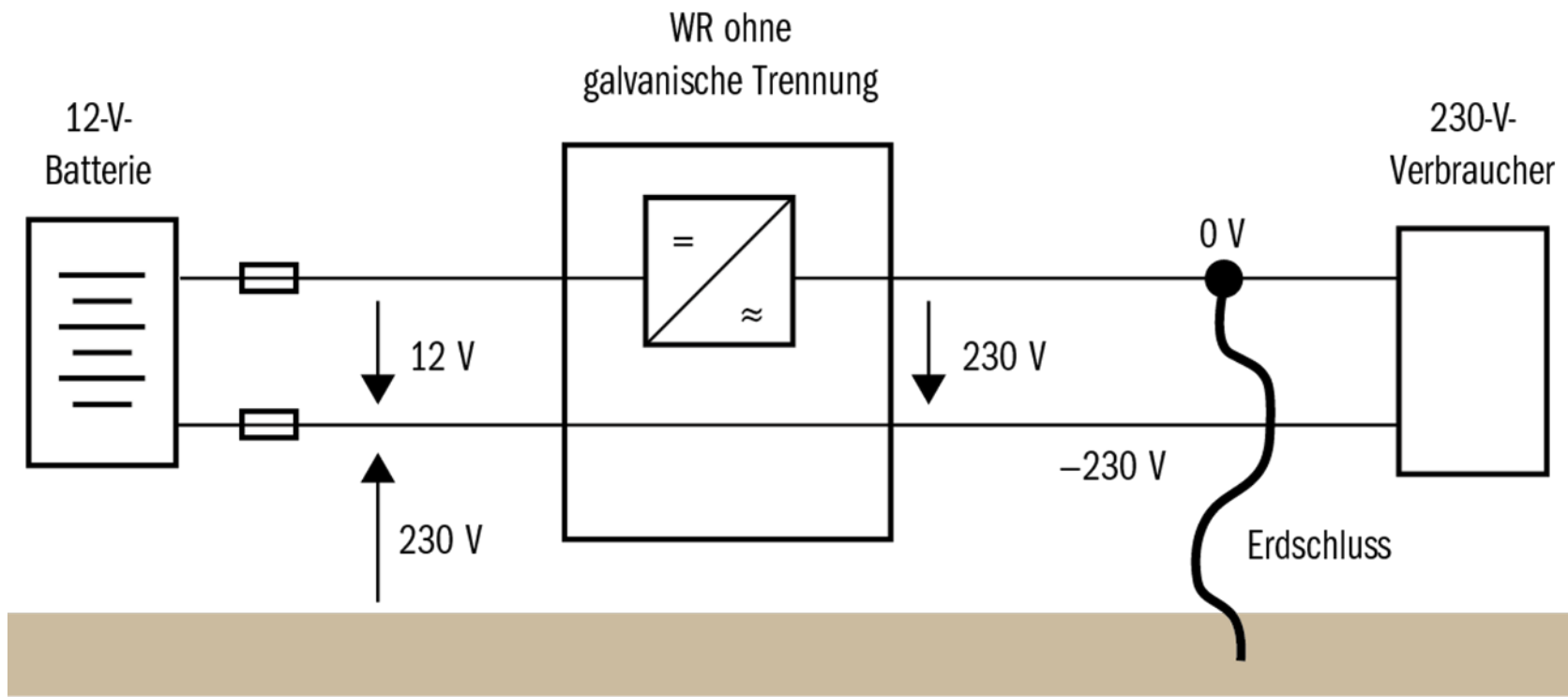

Quelle: Christof Bucher, Photovoltaikanlagen, Faktor Verlag 2021

Schutzwinkel α in Grad

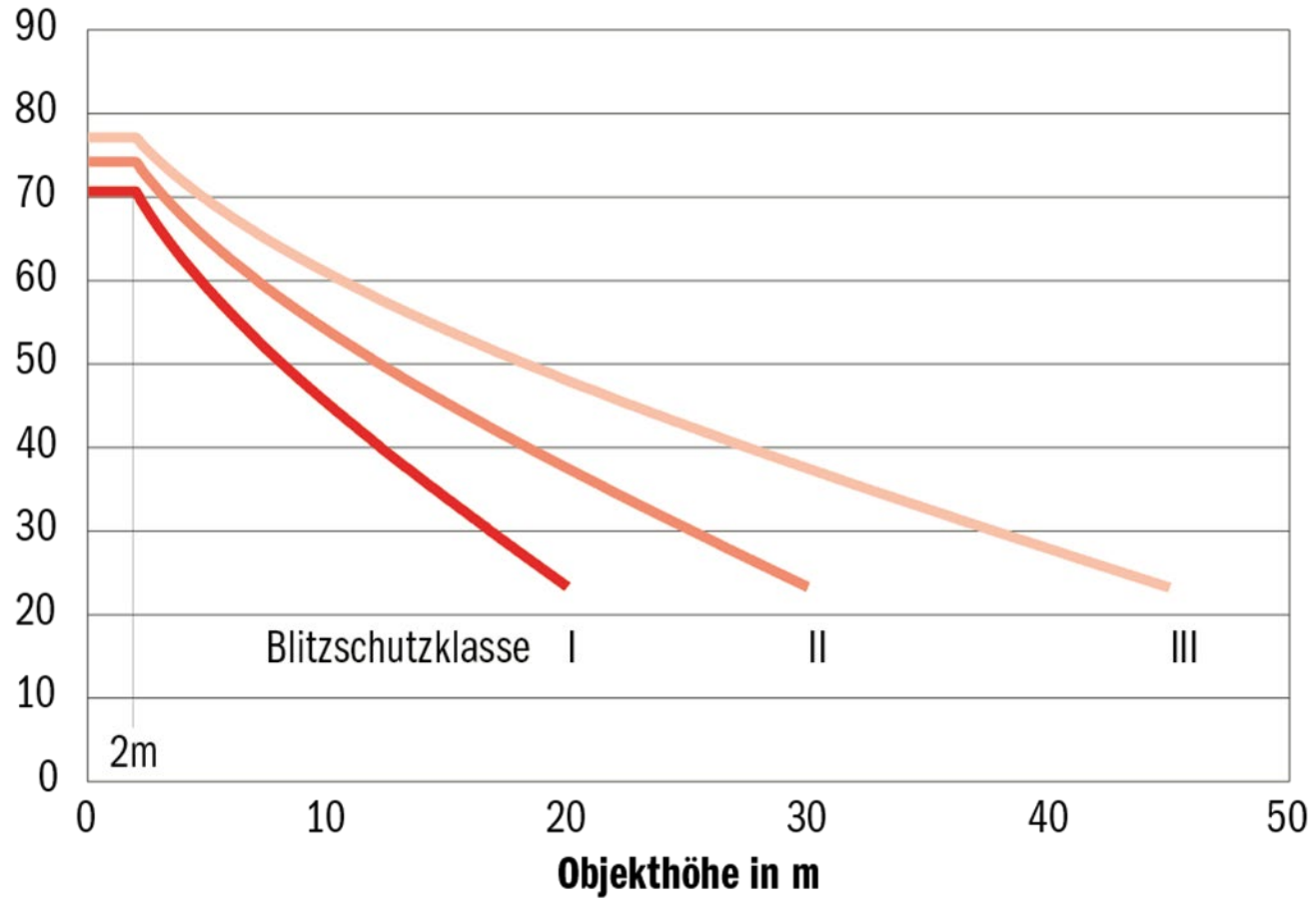

Quelle: Christof Bucher, Photovoltaikanlagen, Faktor Verlag 2021

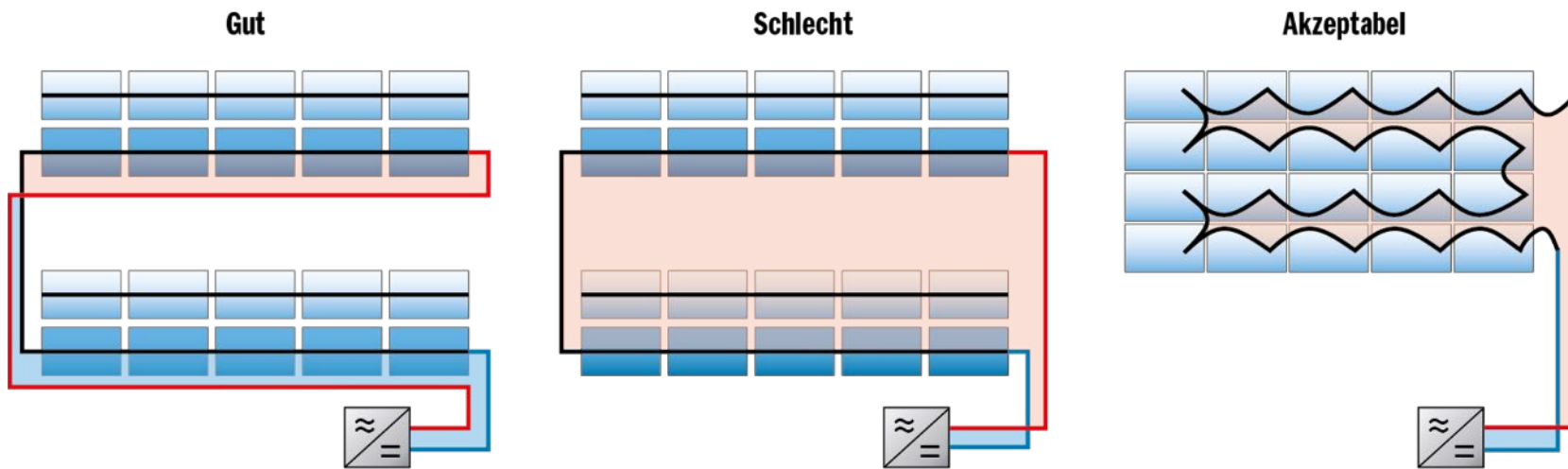

Quelle: Christof Bucher, Photovoltaikanlagen, Faktor Verlag 2021

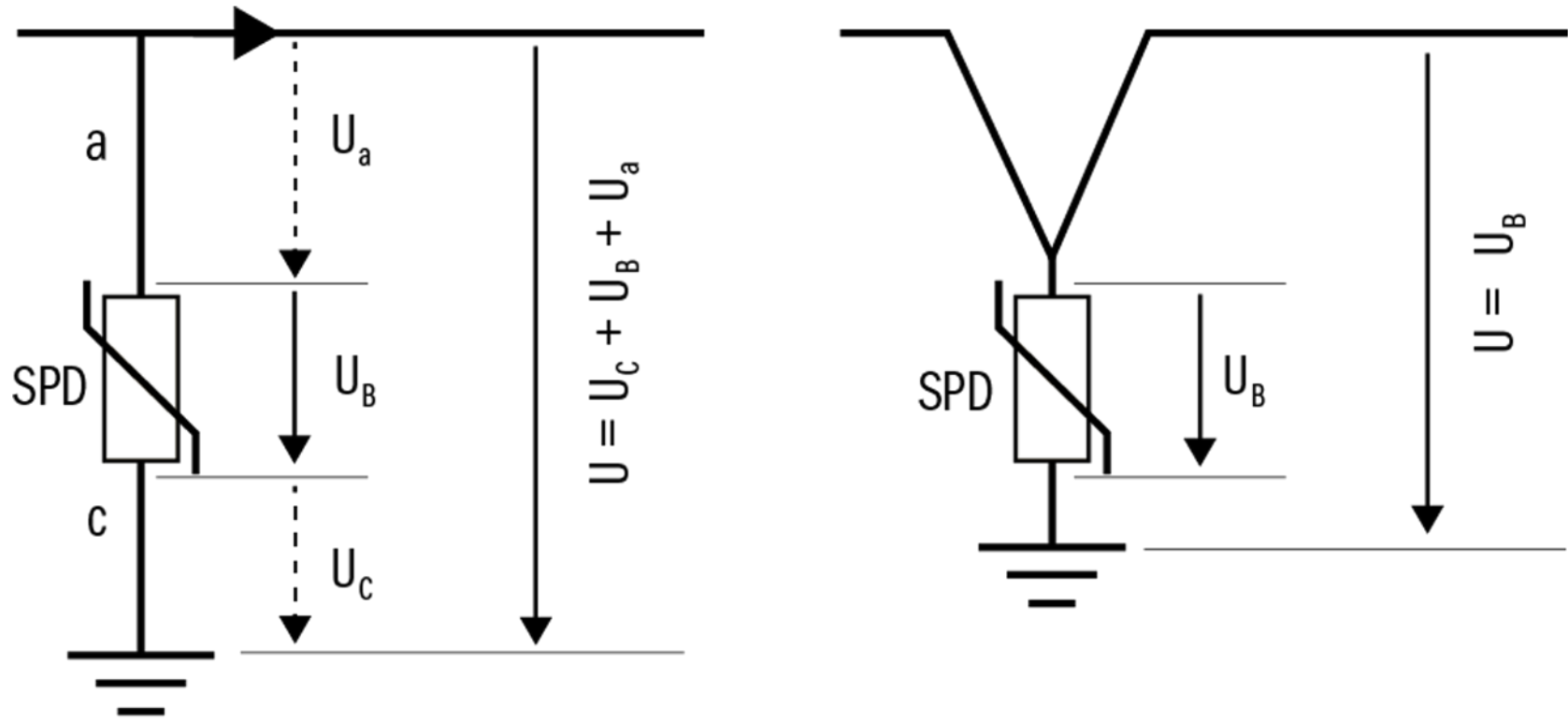

Quelle: Christof Bucher, Photovoltaikanlagen, Faktor Verlag 2021

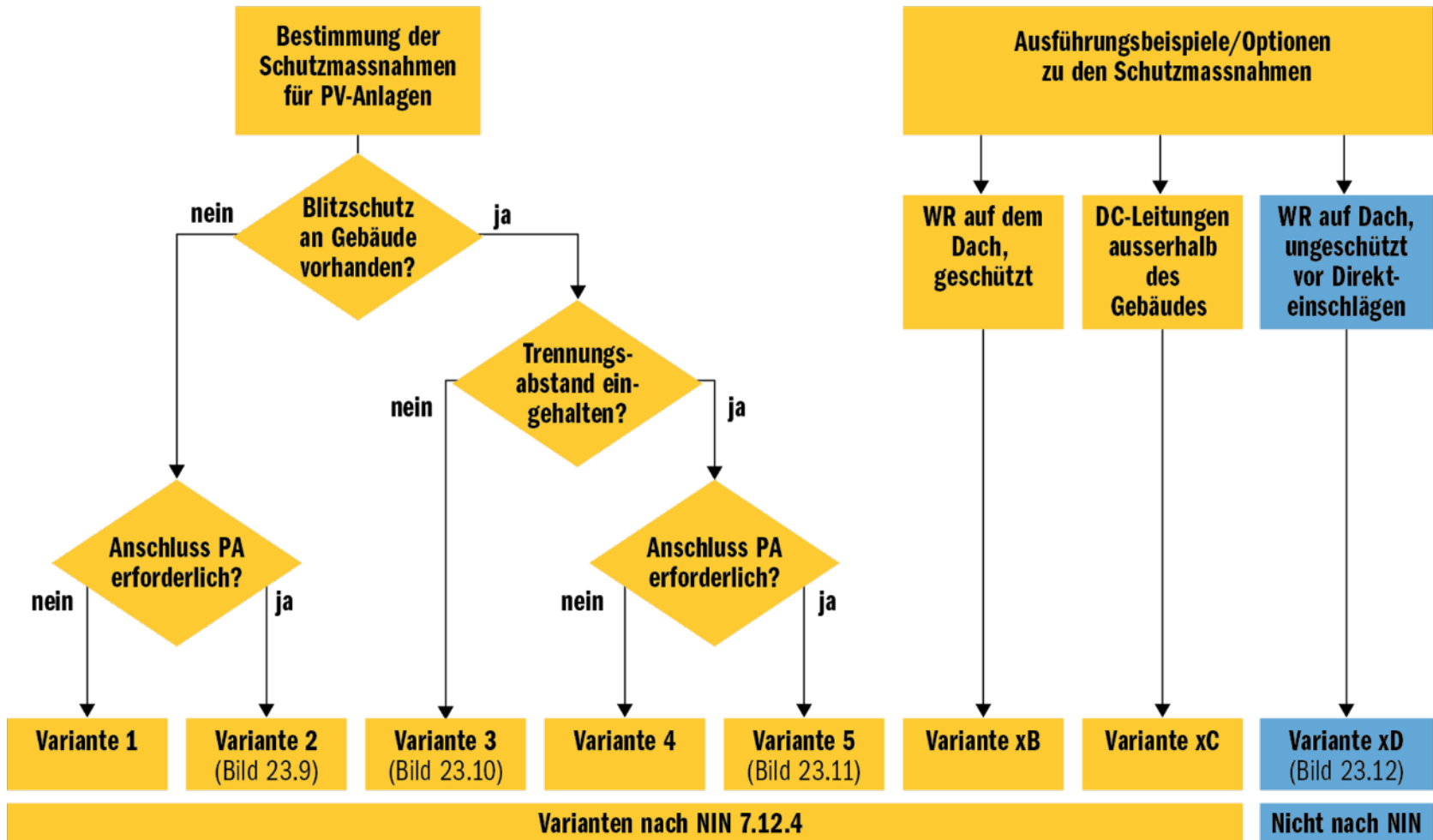

Quelle: Christof Bucher, Photovoltaikanlagen, Faktor Verlag 2021

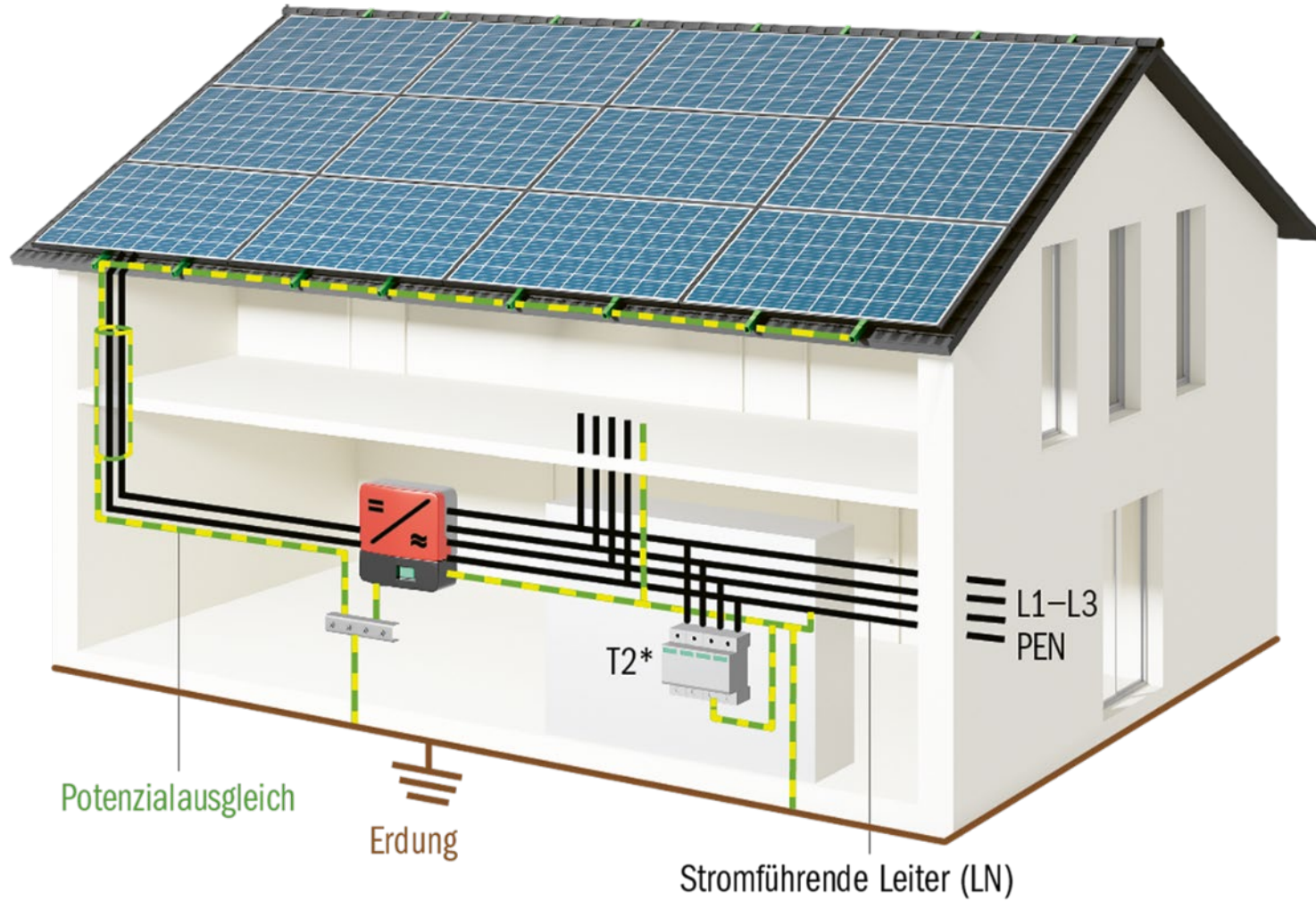

Quelle: Christof Bucher, Photovoltaikanlagen, Faktor Verlag 2021

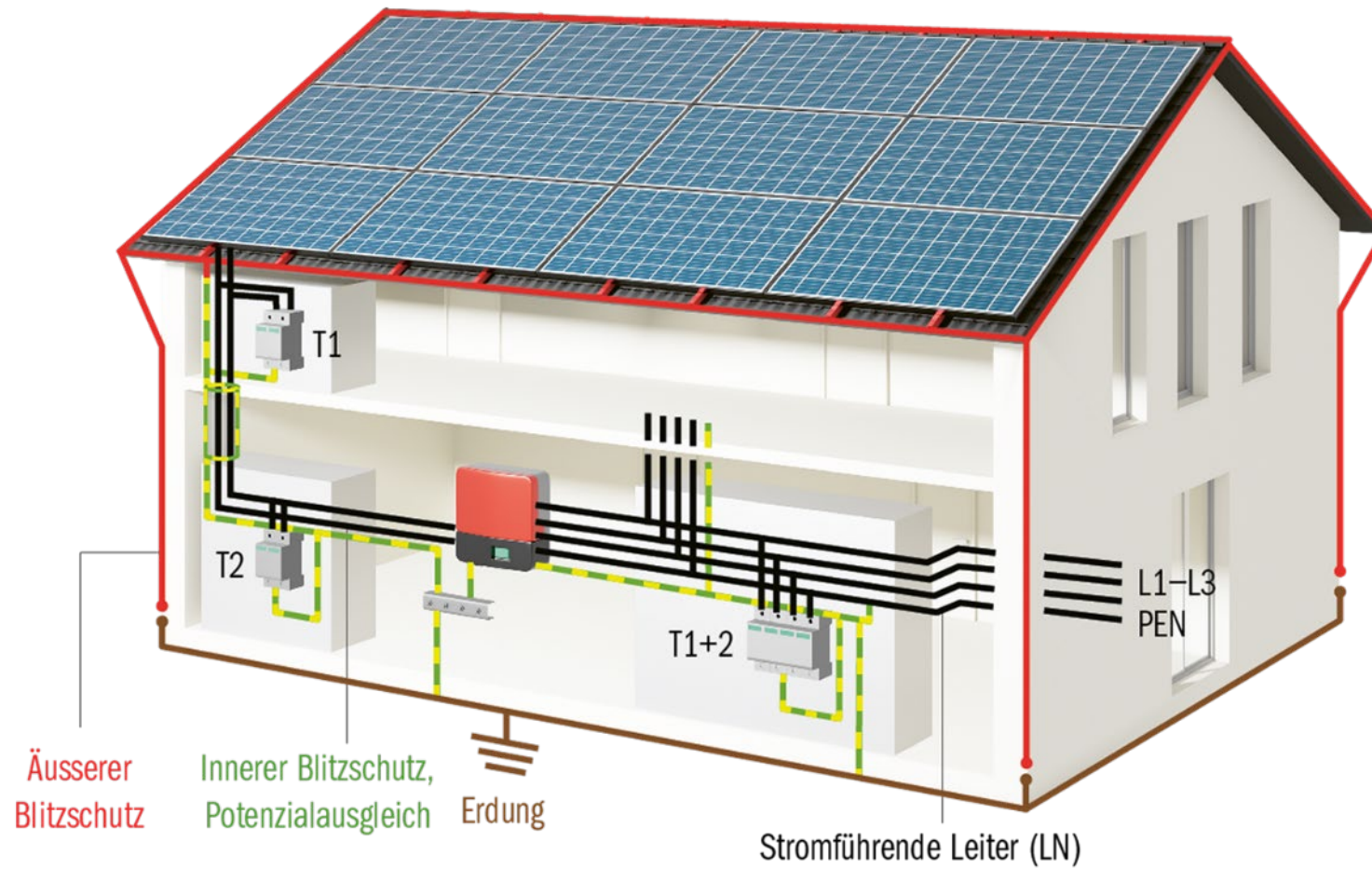

Quelle: Christof Bucher, Photovoltaikanlagen, Faktor Verlag 2021

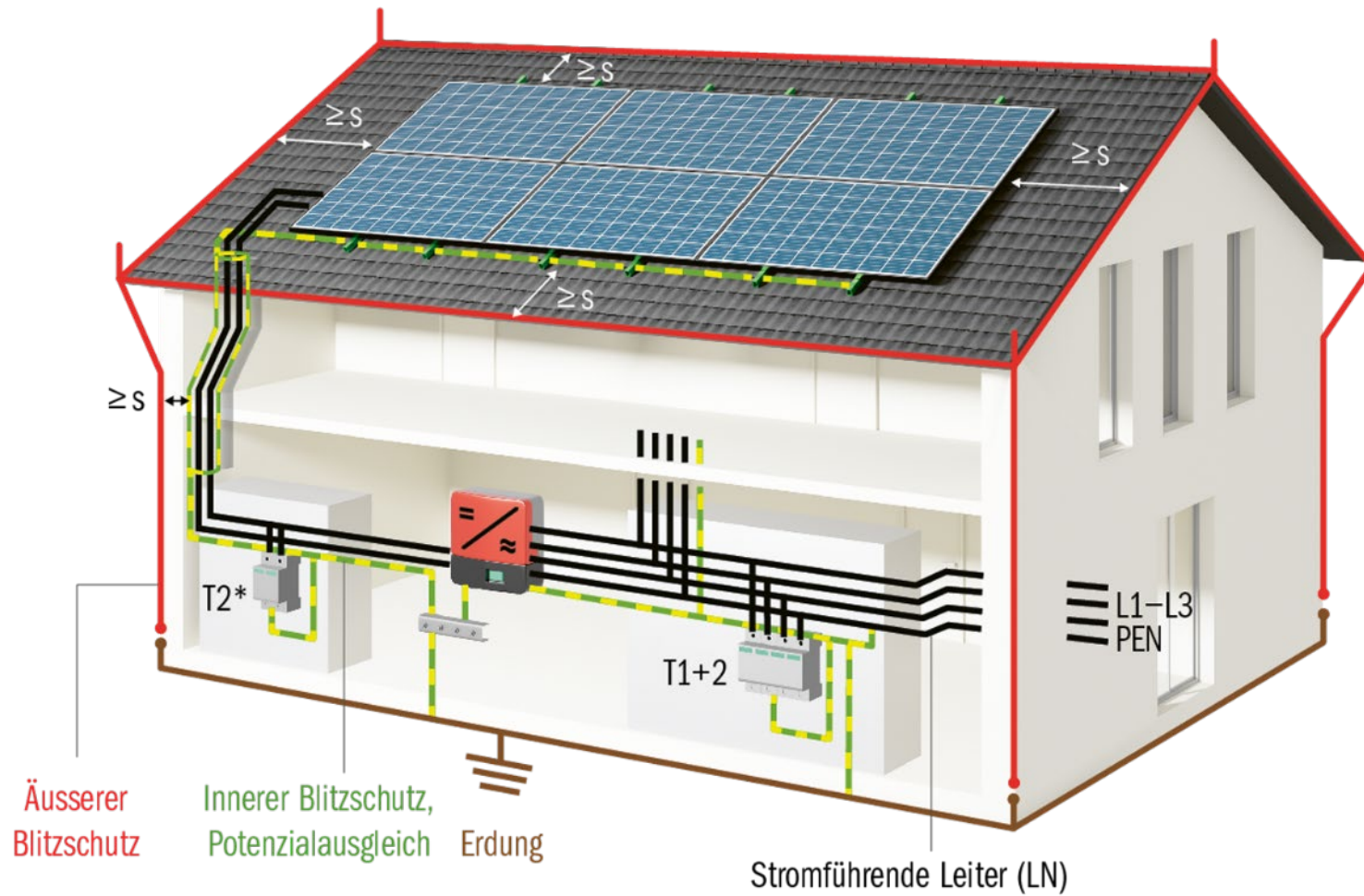

Quelle: Christof Bucher, Photovoltaikanlagen, Faktor Verlag 2021

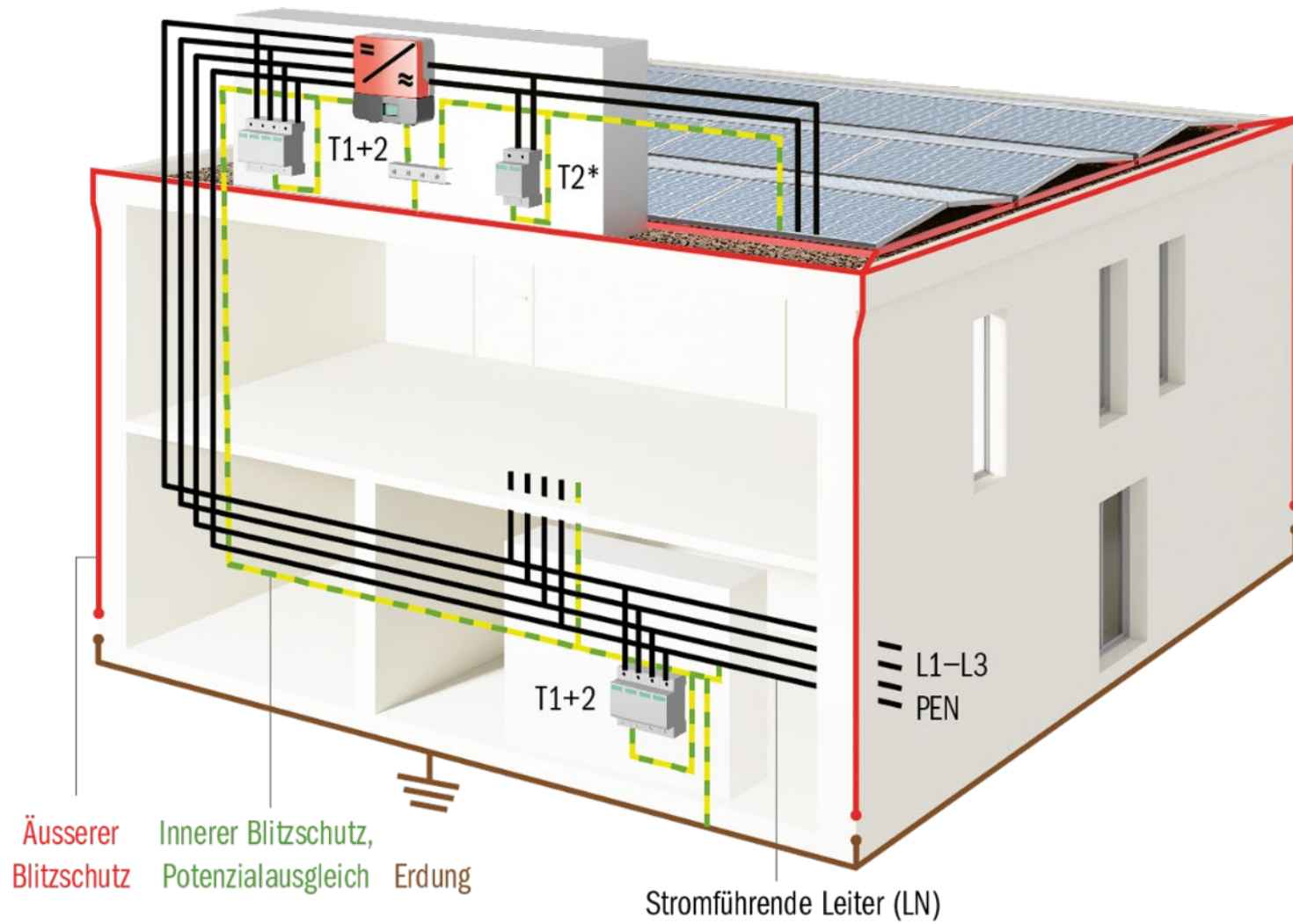

Quelle: Christof Bucher, Photovoltaikanlagen, Faktor Verlag 2021

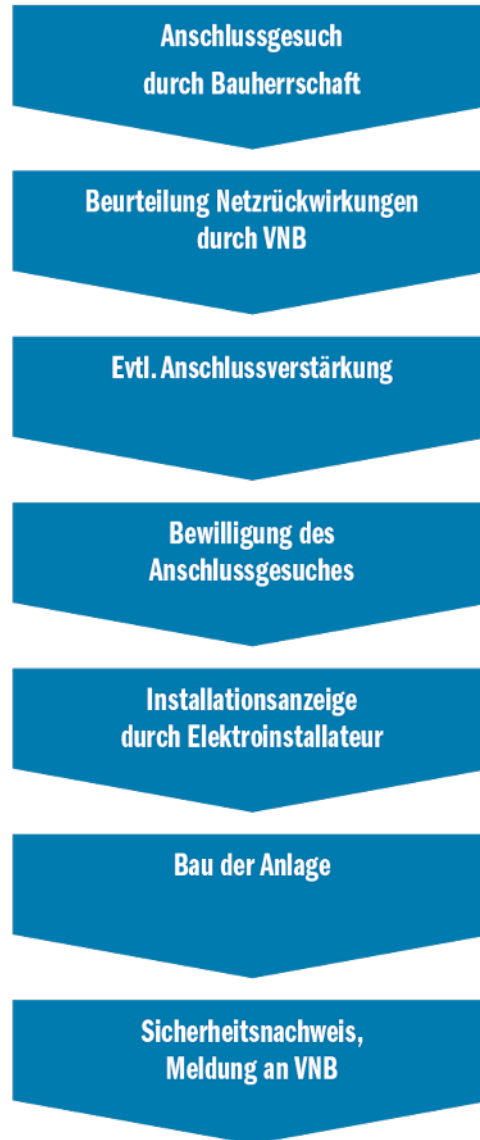

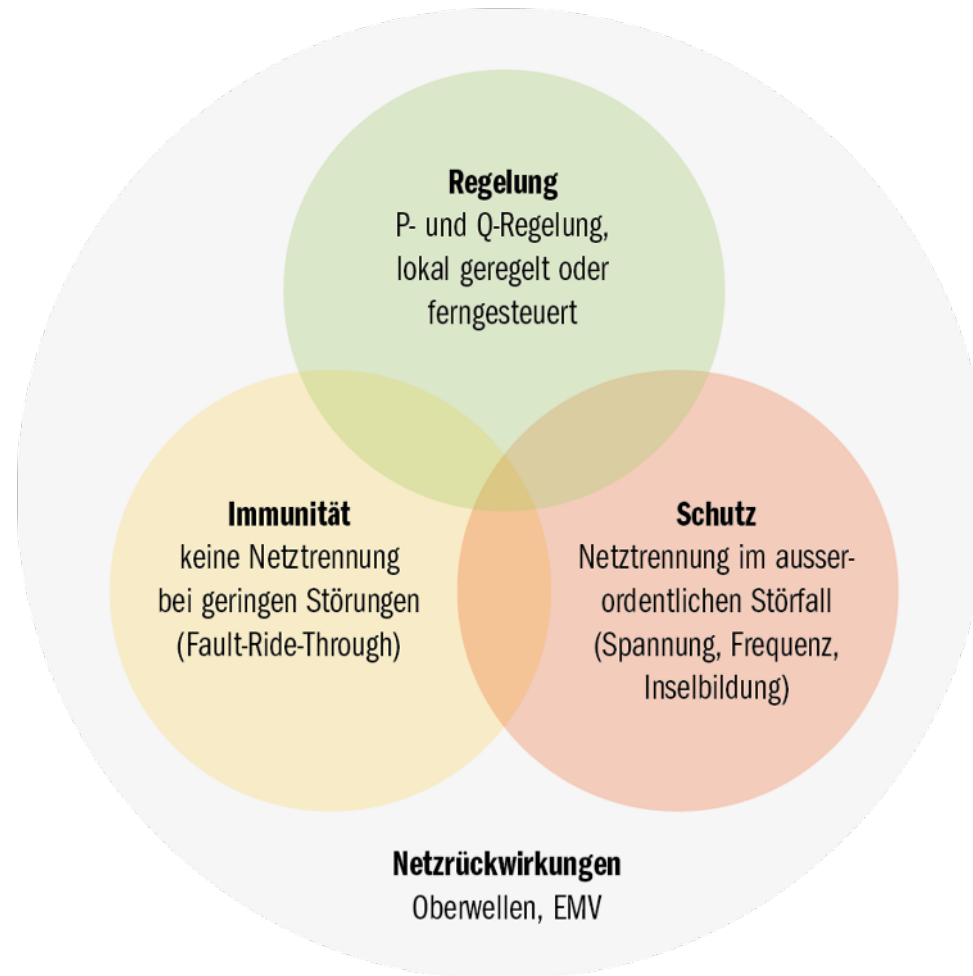

Quelle: Christof Bucher, Photovoltaikanlagen, Faktor Verlag 2021

Spannung U in V

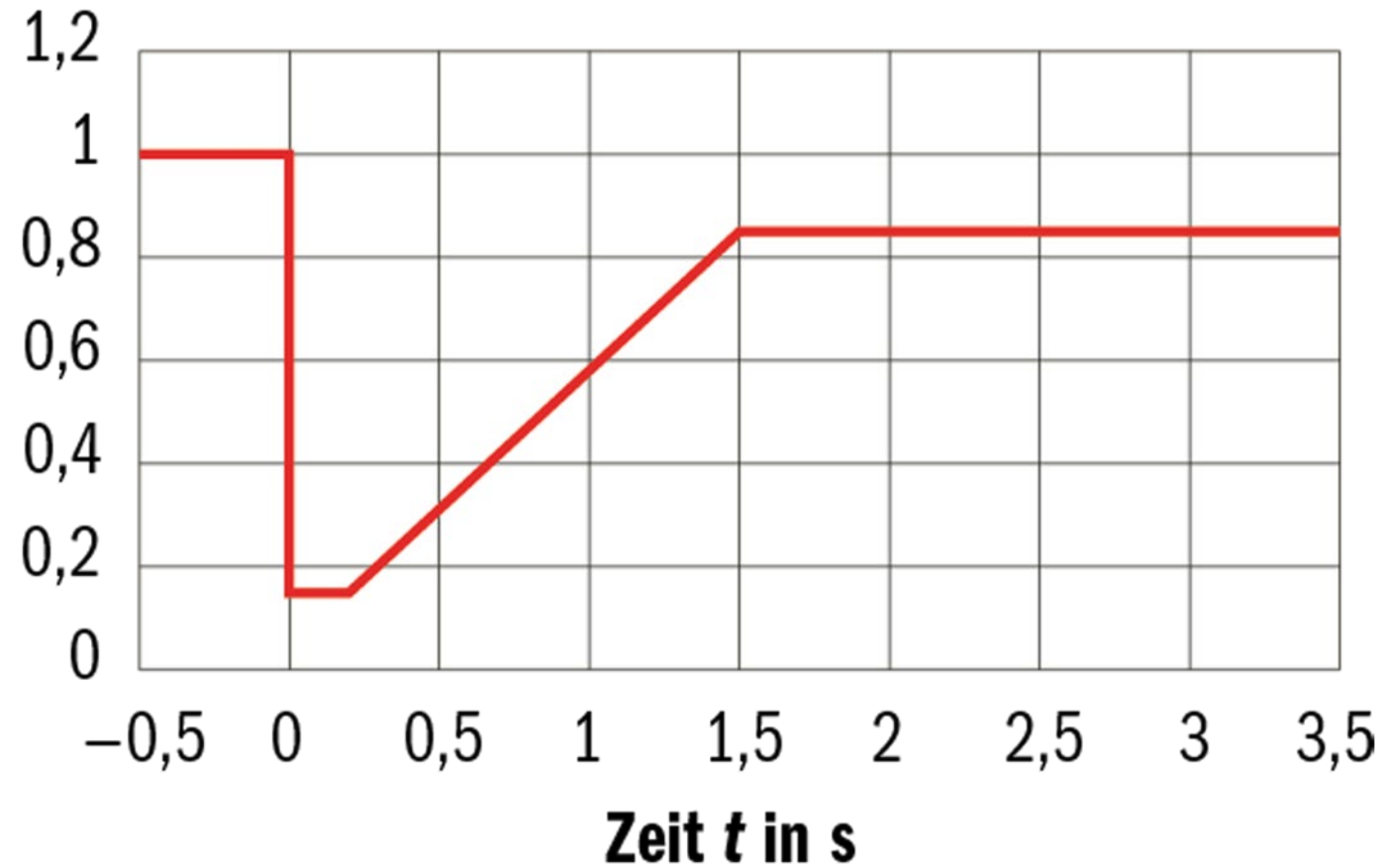

Quelle: Christof Bucher, Photovoltaikanlagen, Faktor Verlag 2021

Spannung U in V

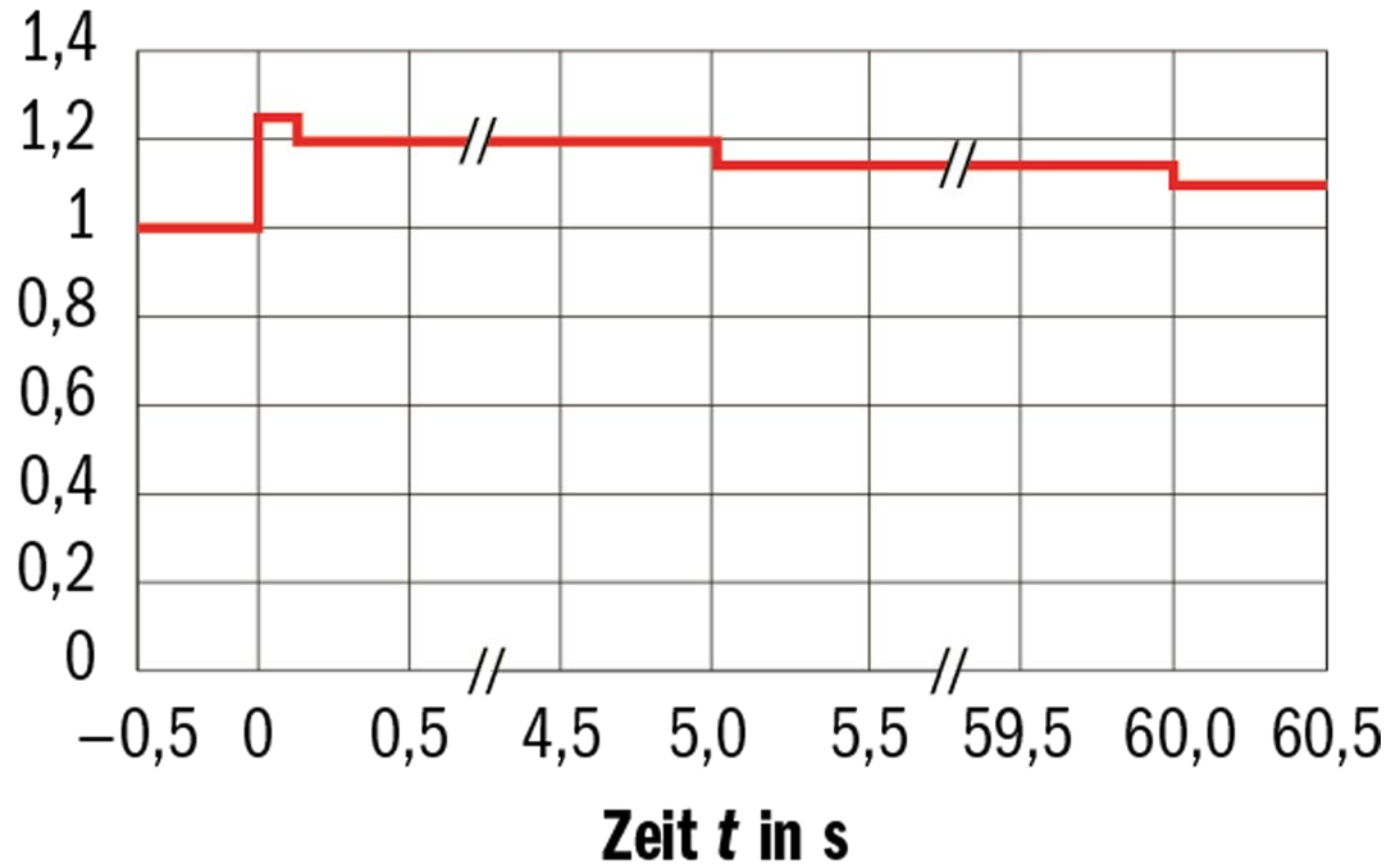

Quelle: Christof Bucher, Photovoltaikanlagen, Faktor Verlag 2021

Frequenz f in Hz

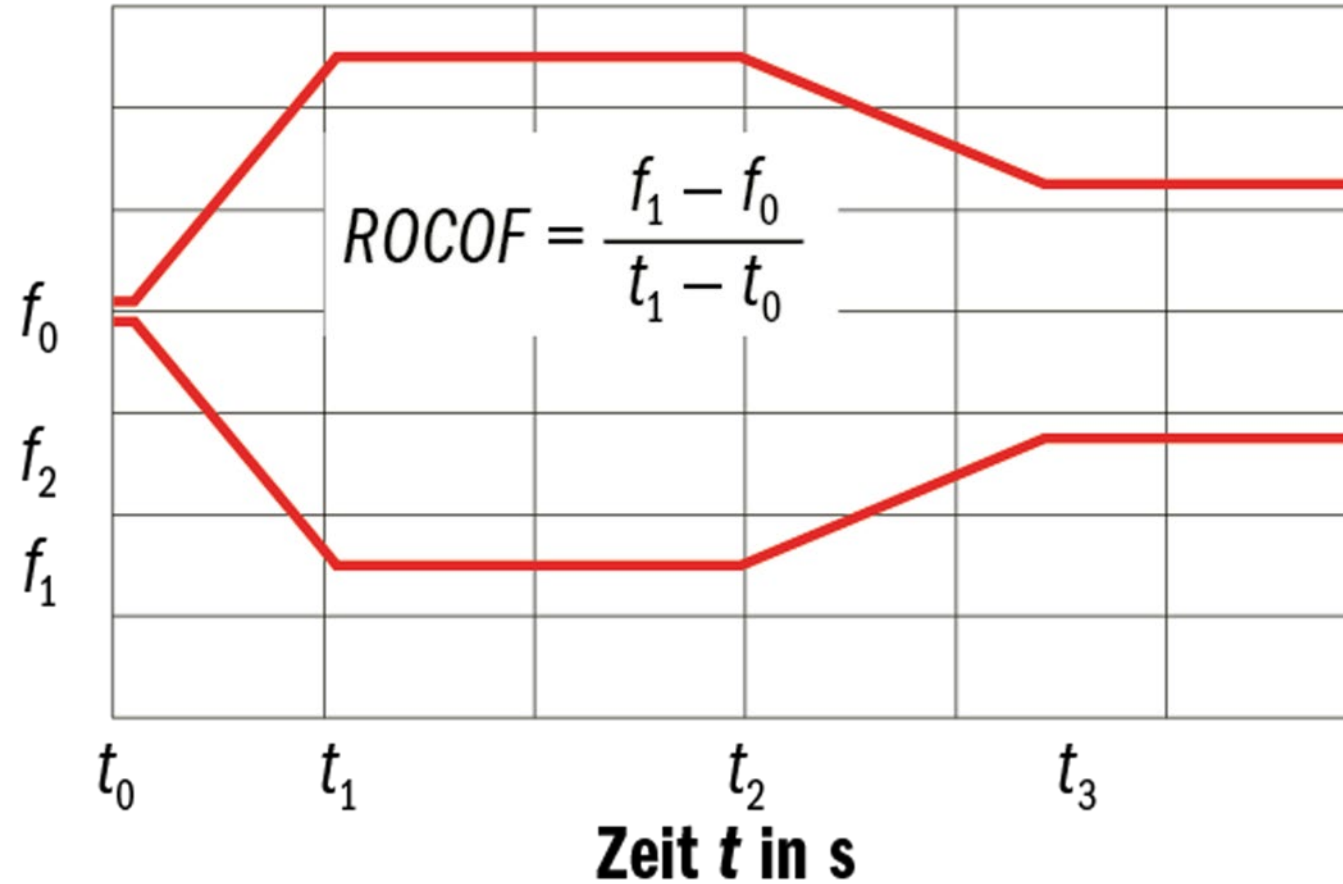

Quelle: Christof Bucher, Photovoltaikanlagen, Faktor Verlag 2021

Elektrisches Feld

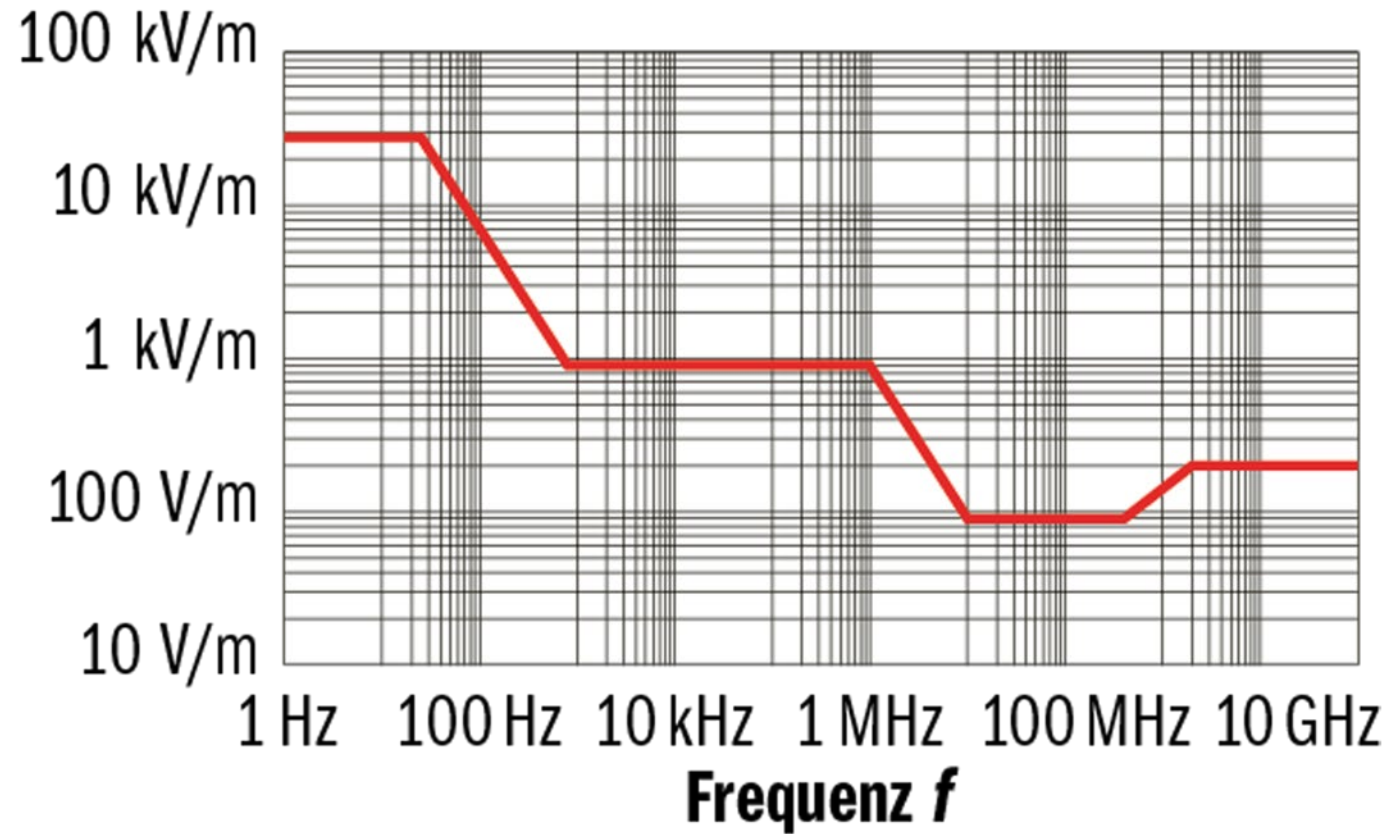

Quelle: Christof Bucher, Photovoltaikanlagen, Faktor Verlag 2021

Relative Wirkleistung P in %

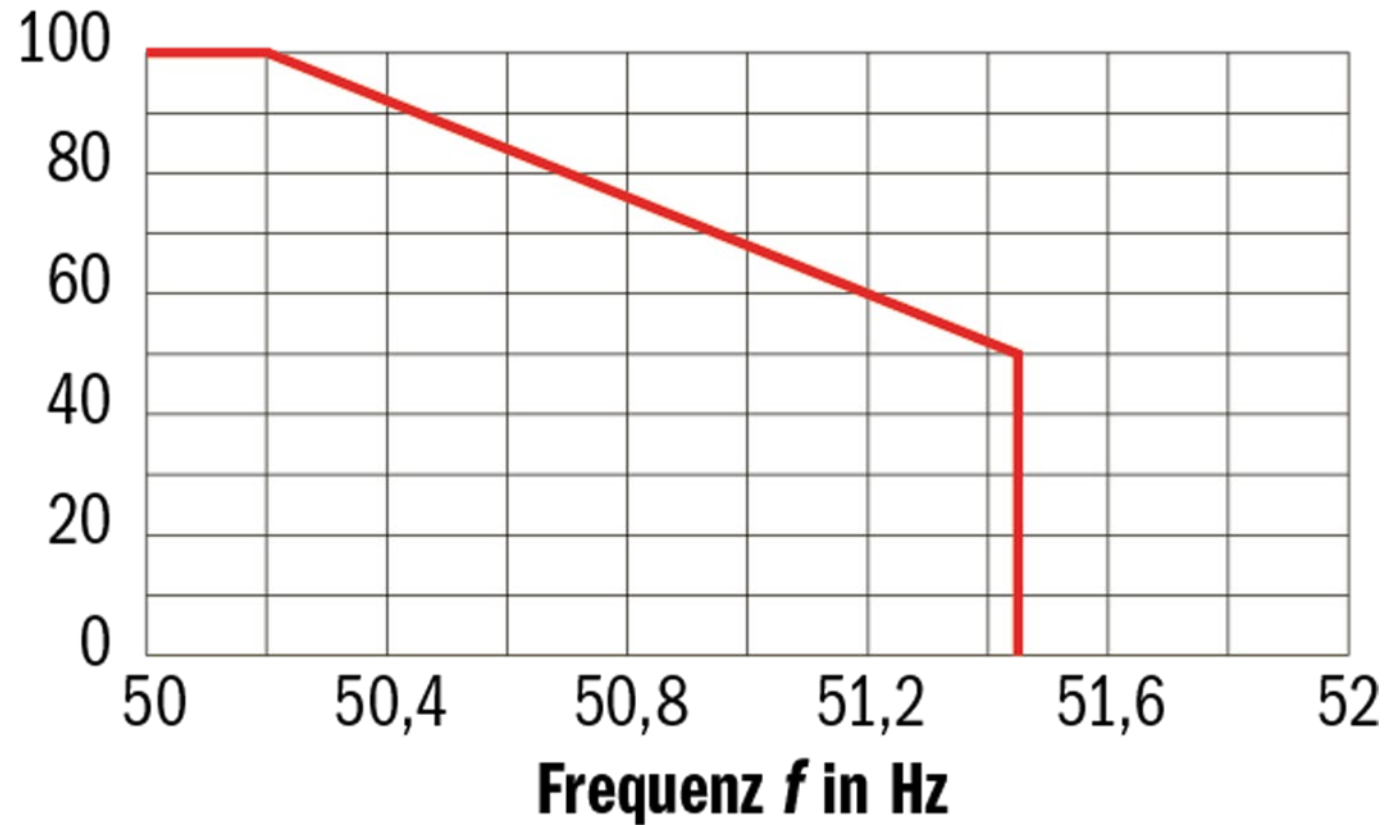

Quelle: Christof Bucher, Photovoltaikanlagen, Faktor Verlag 2021

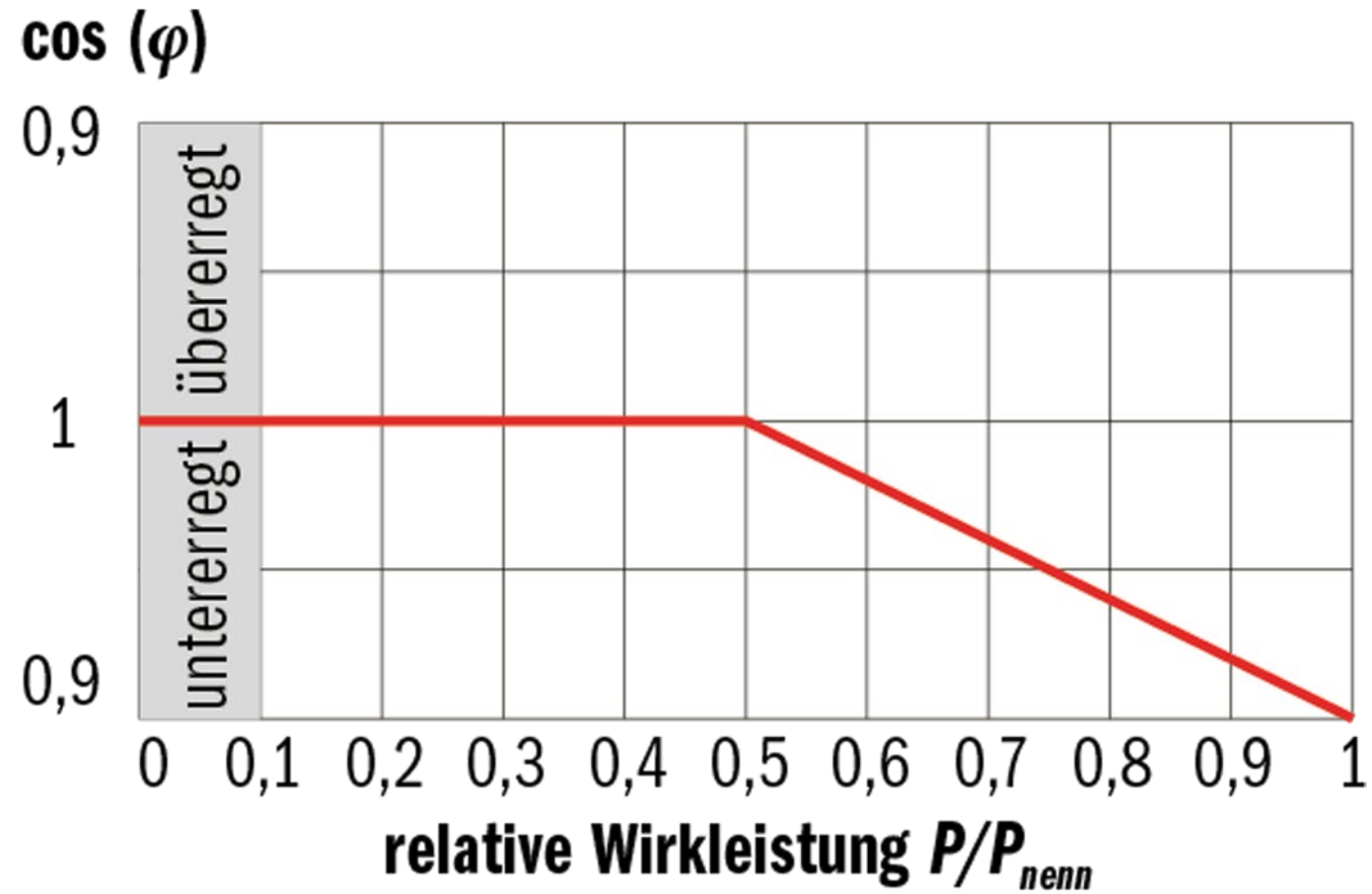

Quelle: Christof Bucher, Photovoltaikanlagen, Faktor Verlag 2021

Blindleistung Q in kVar

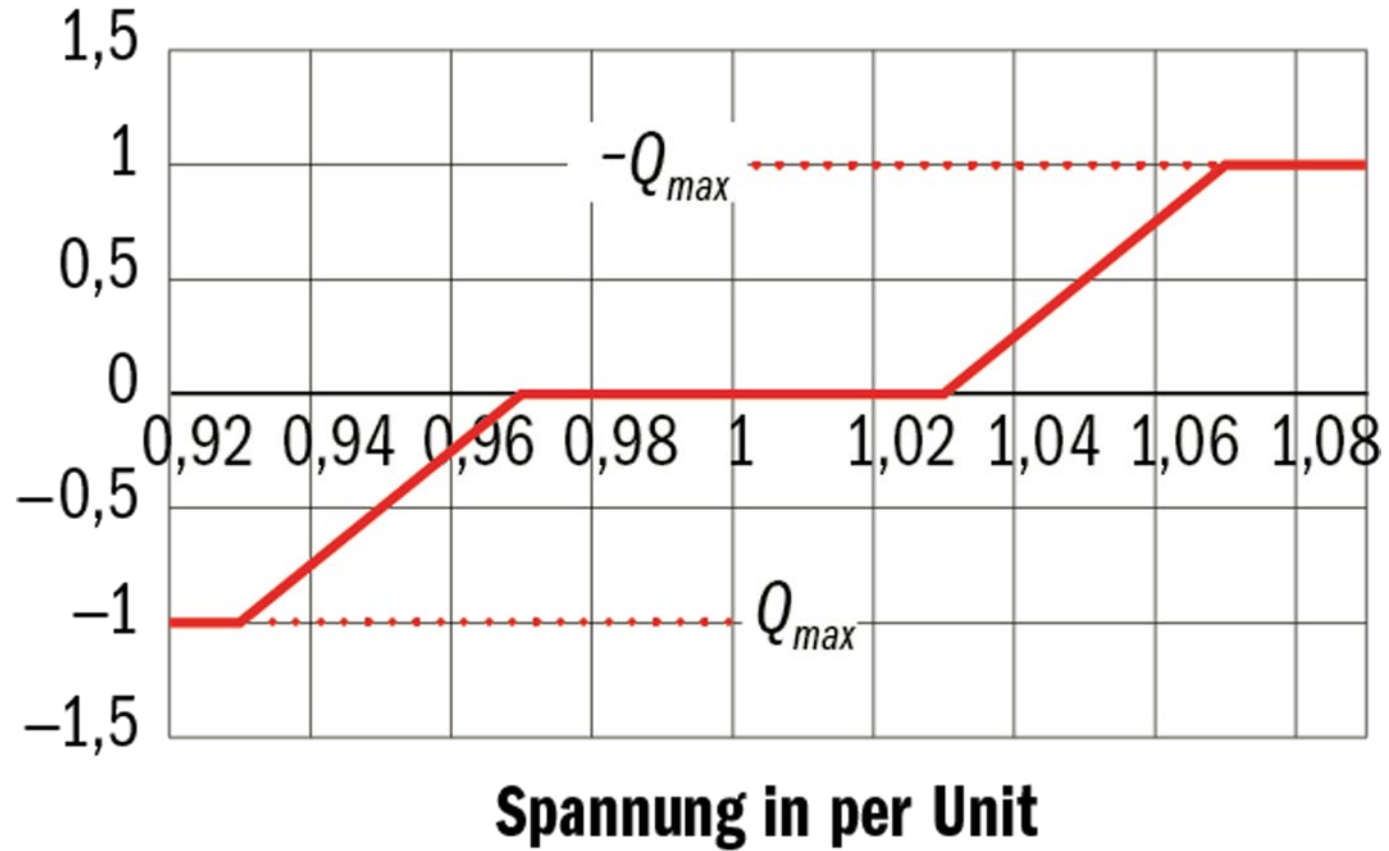

Quelle: Christof Bucher, Photovoltaikanlagen, Faktor Verlag 2021

Relative Wirkleistung P in %

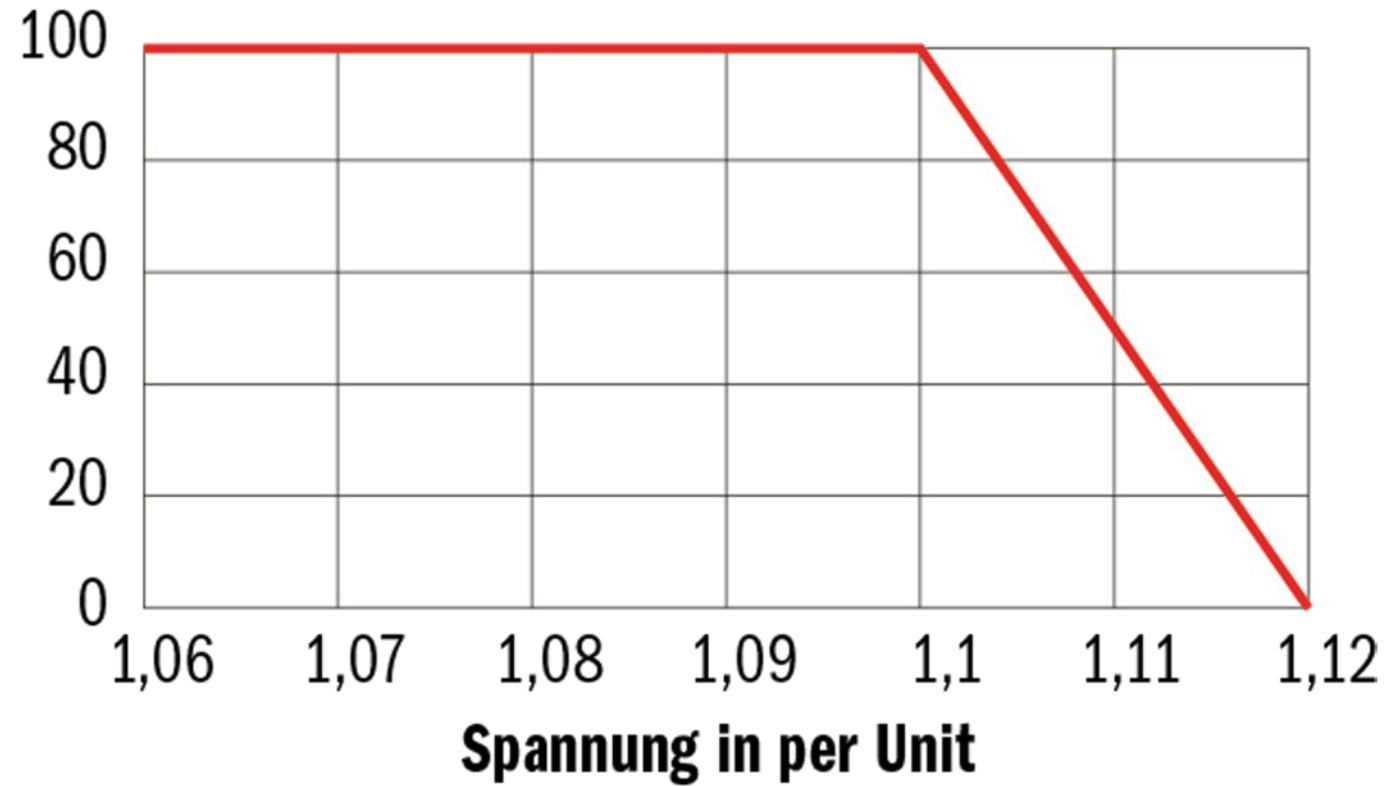

Quelle: Christof Bucher, Photovoltaikanlagen, Faktor Verlag 2021

Relative Wirkleistung P in %

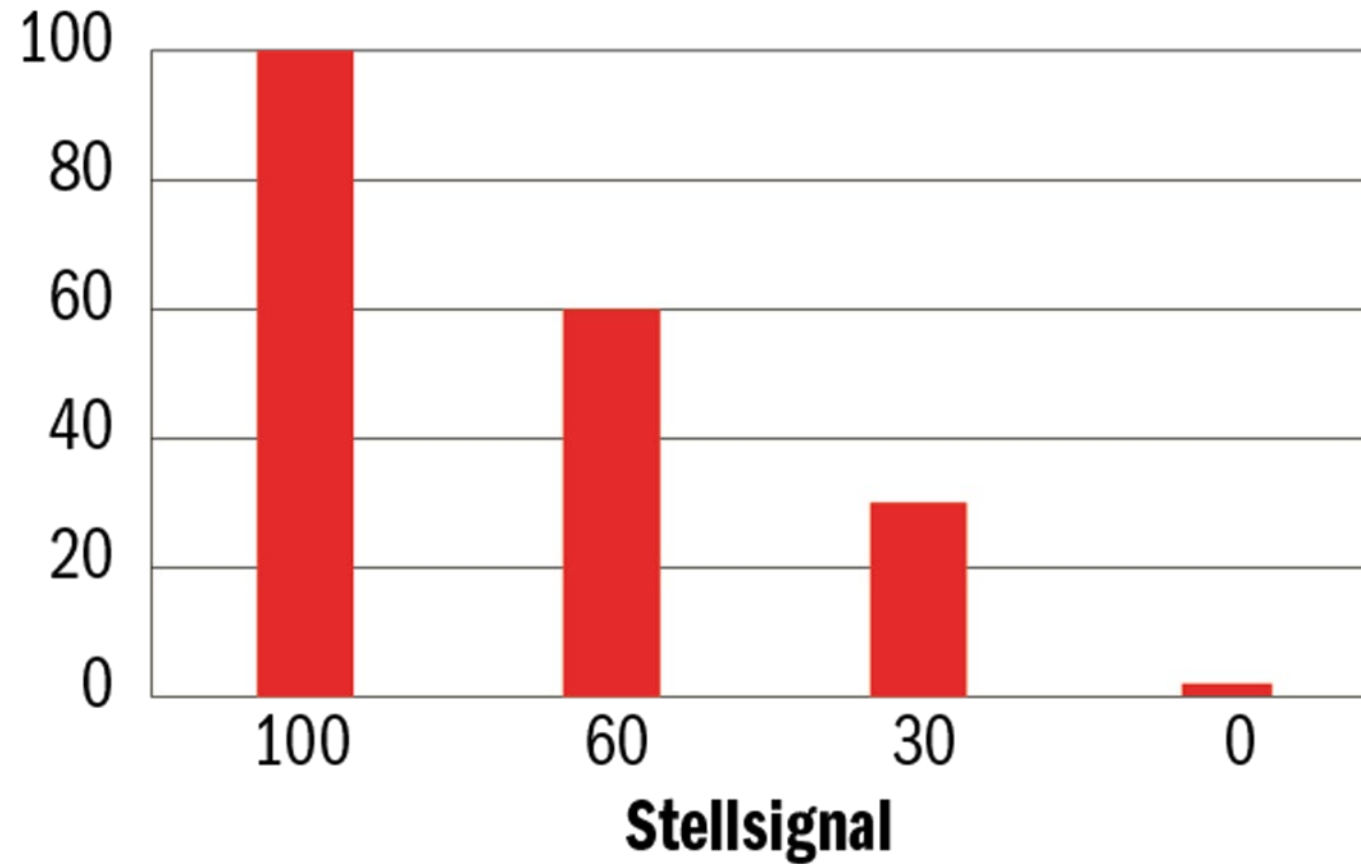

Quelle: Christof Bucher, Photovoltaikanlagen, Faktor Verlag 2021

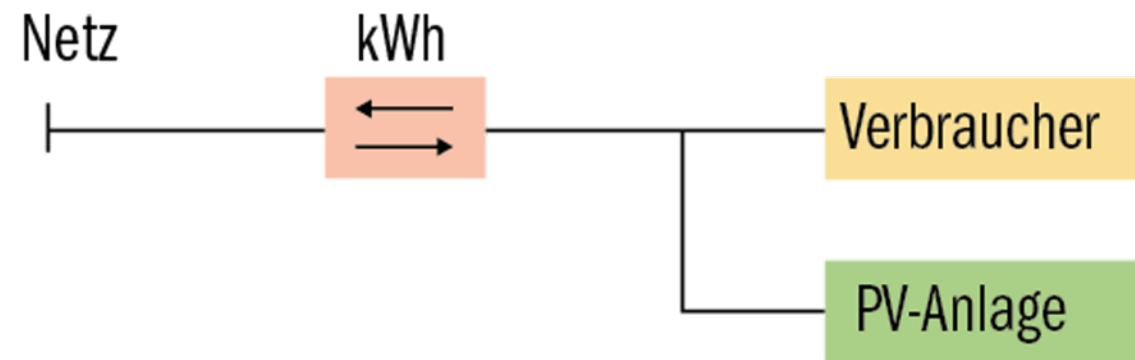

Quelle: Christof Bucher, Photovoltaikanlagen, Faktor Verlag 2021

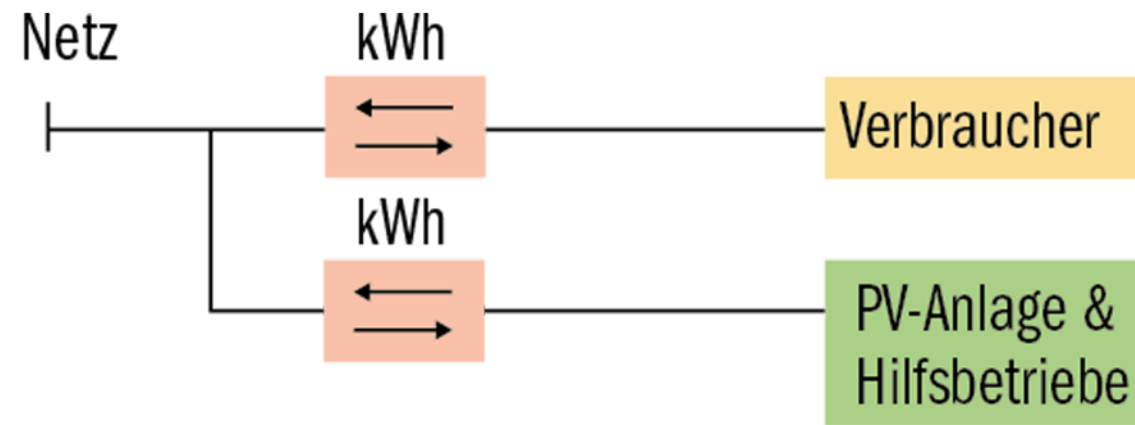

Quelle: Christof Bucher, Photovoltaikanlagen, Faktor Verlag 2021

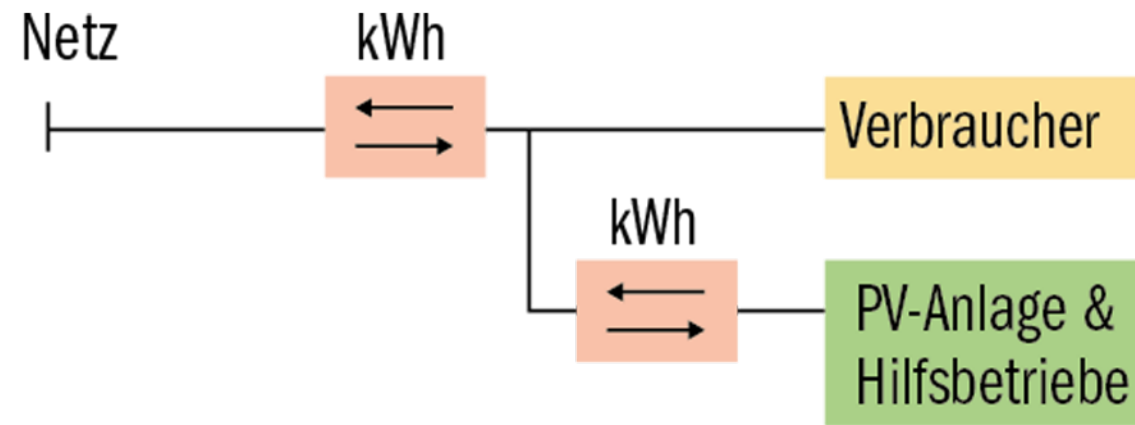

Quelle: Christof Bucher, Photovoltaikanlagen, Faktor Verlag 2021

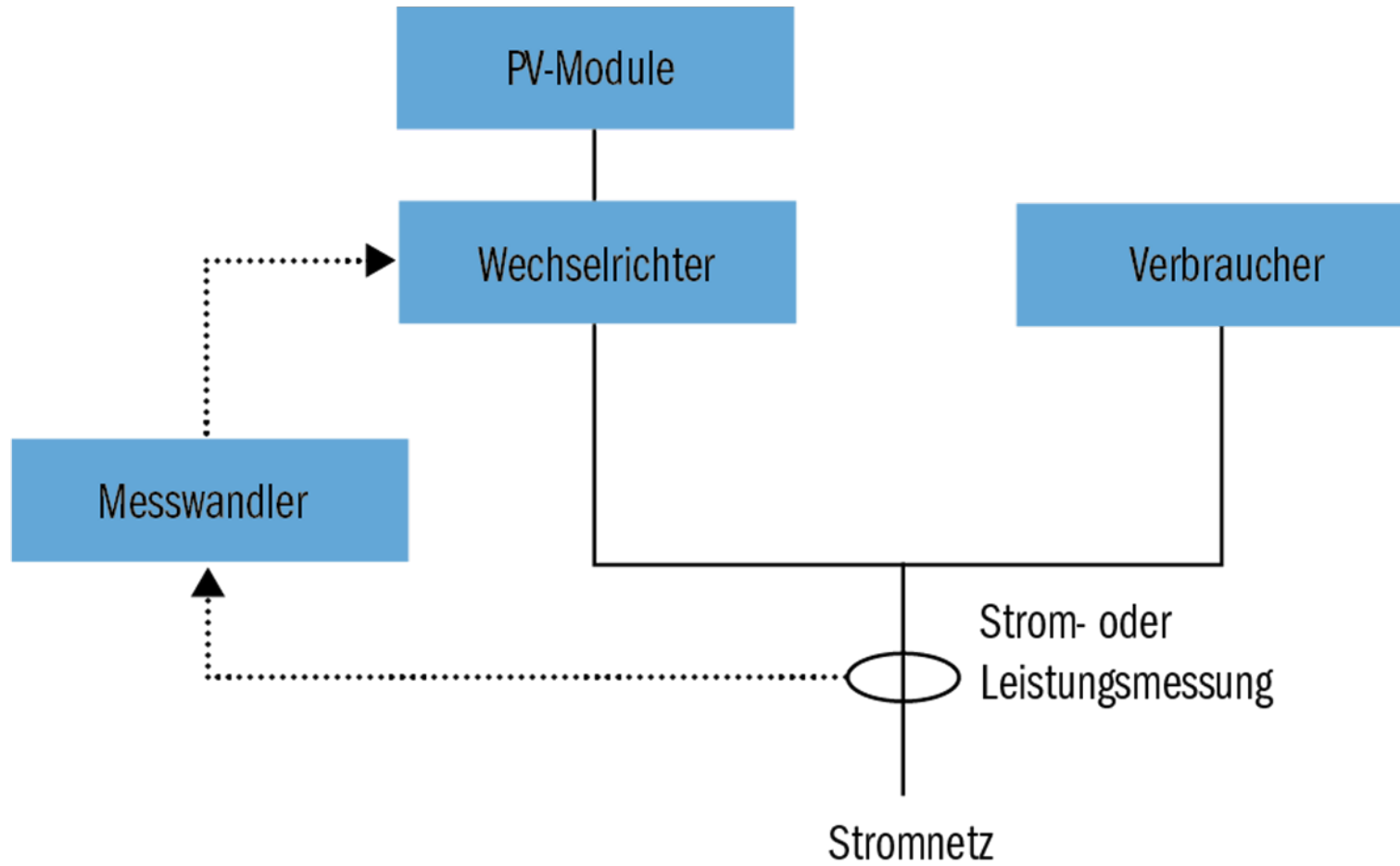

Quelle: Christof Bucher, Photovoltaikanlagen, Faktor Verlag 2021

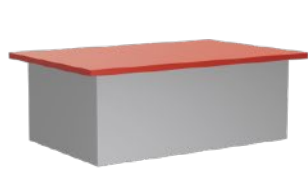

Flachdach

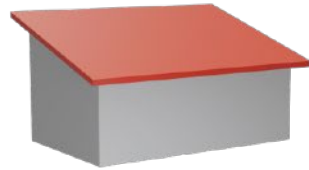

Pulldach

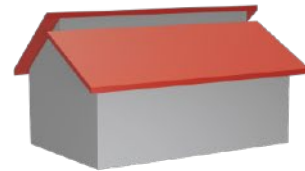

Versetztes Pulldach

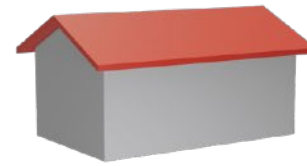

Satteldach

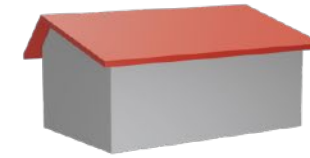

Frackdach

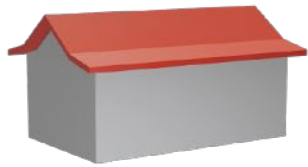

Knickdach

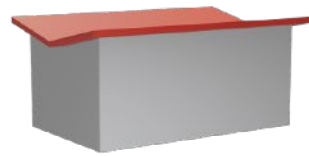

Schmetterlingsdach

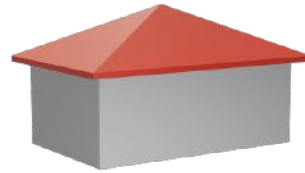

Zeltdach

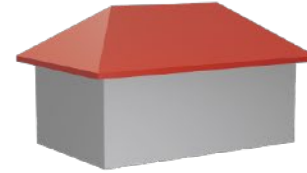

Walmdach

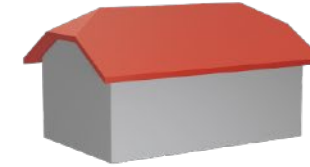

Krüppelwalmdach



Mansardengiebel

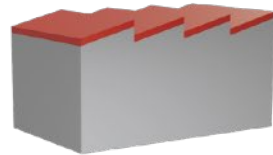

Sheddach

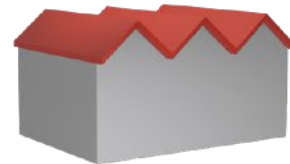

Paralleldach

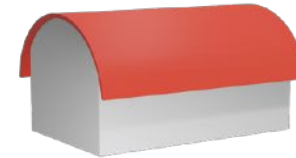

Tonnendach

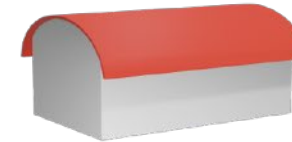

Bogendach

Quelle: Christof Bucher, Photovoltaikanlagen, Faktor Verlag 2021

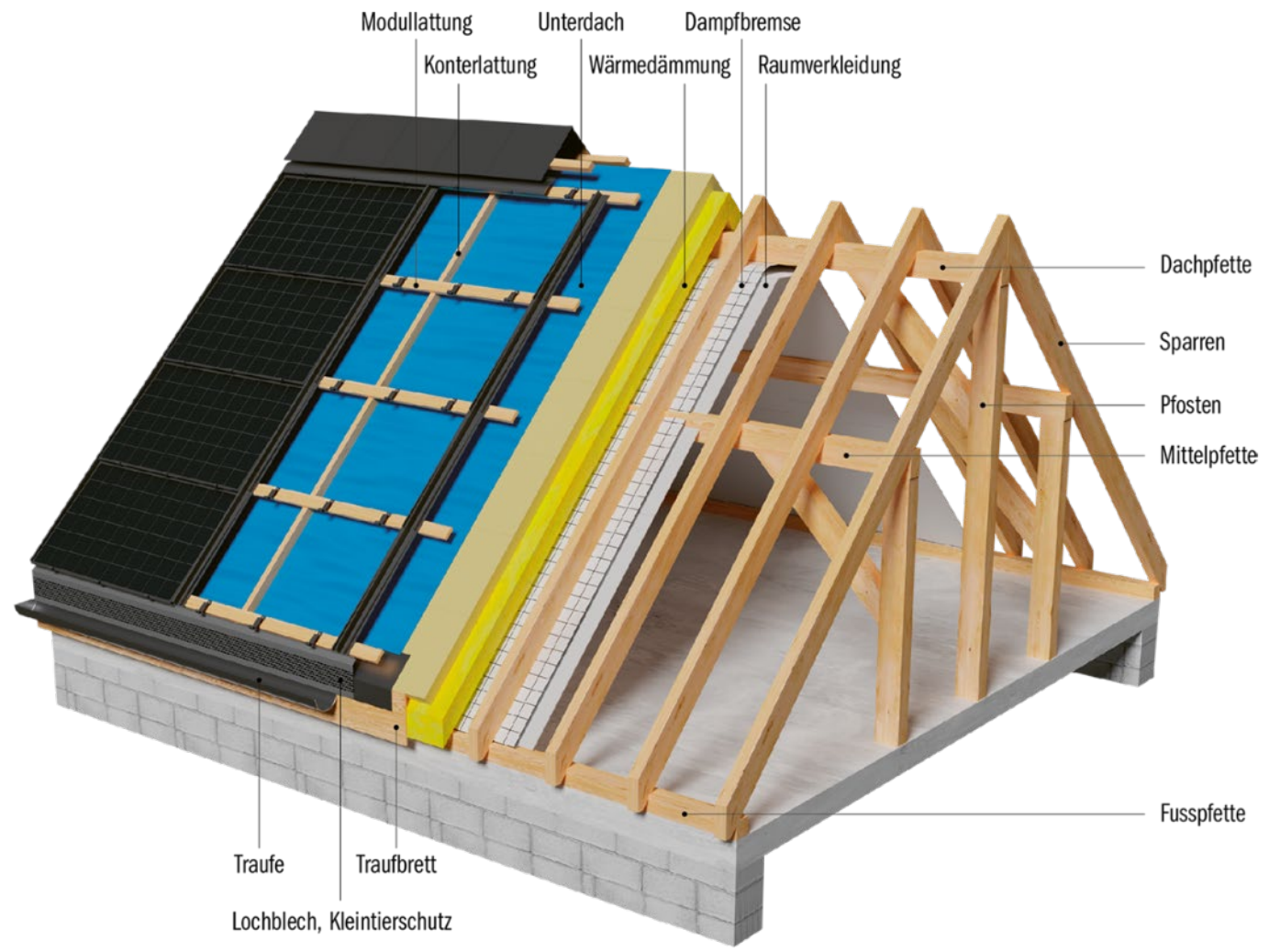

Quelle: Christof Bucher, Photovoltaikanlagen, Faktor Verlag 2021



Quelle: Christof Bucher, Photovoltaikanlagen, Faktor Verlag 2021



Quelle: Christof Bucher, Photovoltaikanlagen, Faktor Verlag 2021



Quelle: Christof Bucher, Photovoltaikanlagen, Faktor Verlag 2021



Quelle: Christof Bucher, Photovoltaikanlagen, Faktor Verlag 2021



Quelle: Christof Bucher, Photovoltaikanlagen, Faktor Verlag 2021



Quelle: Christof Bucher, Photovoltaikanlagen, Faktor Verlag 2021



Quelle: Christof Bucher, Photovoltaikanlagen, Faktor Verlag 2021



Quelle: Christof Bucher, Photovoltaikanlagen, Faktor Verlag 2021



Quelle: Christof Bucher, Photovoltaikanlagen, Faktor Verlag 2021

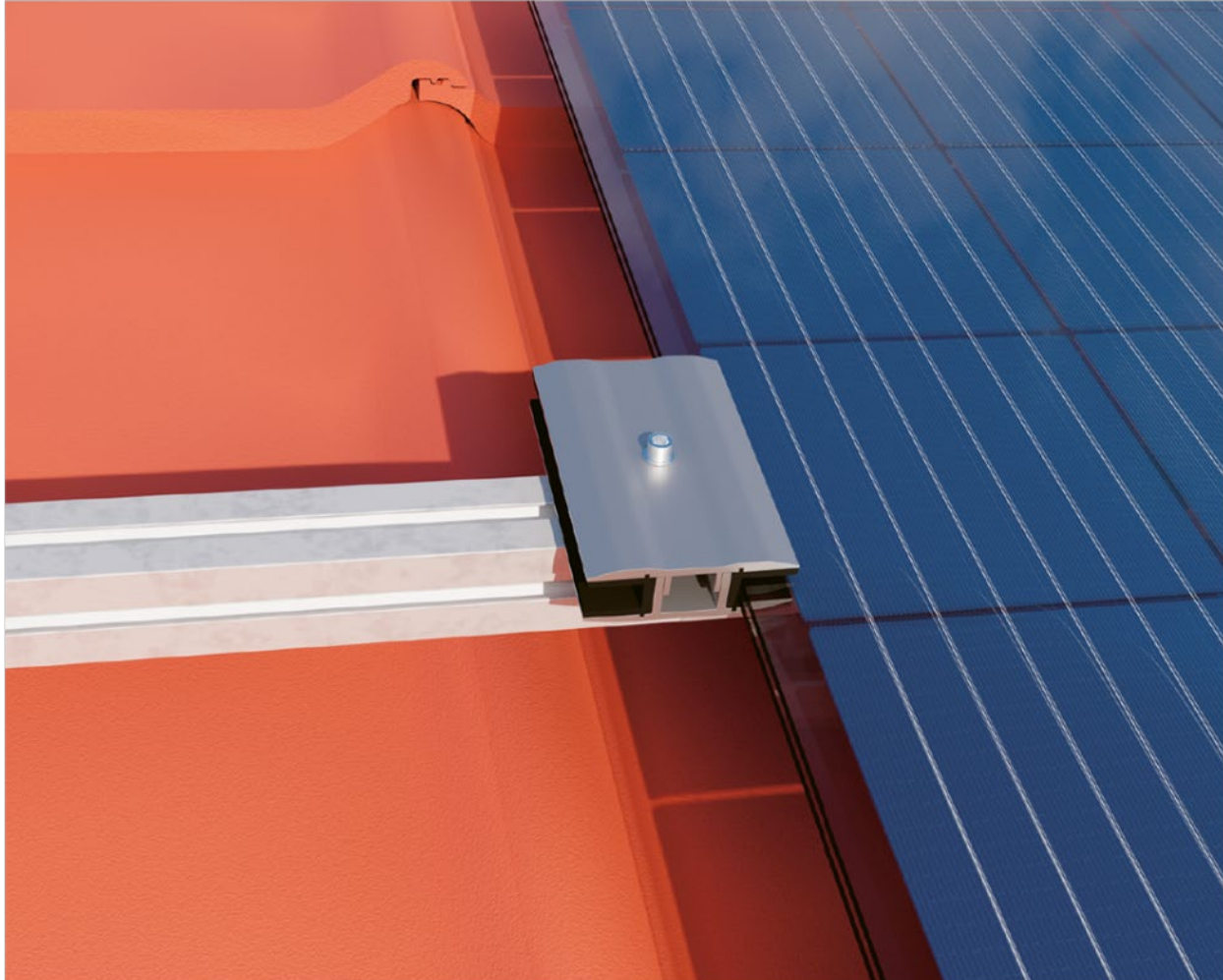

Quelle: Christof Bucher, Photovoltaikanlagen, Faktor Verlag 2021



Quelle: Christof Bucher, Photovoltaikanlagen, Faktor Verlag 2021

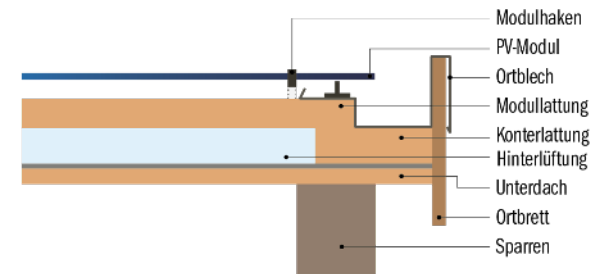
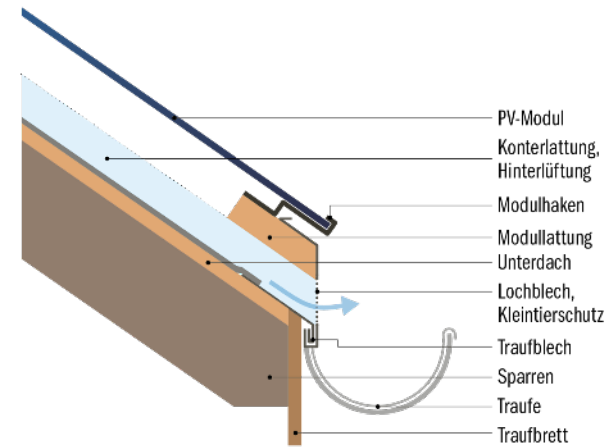
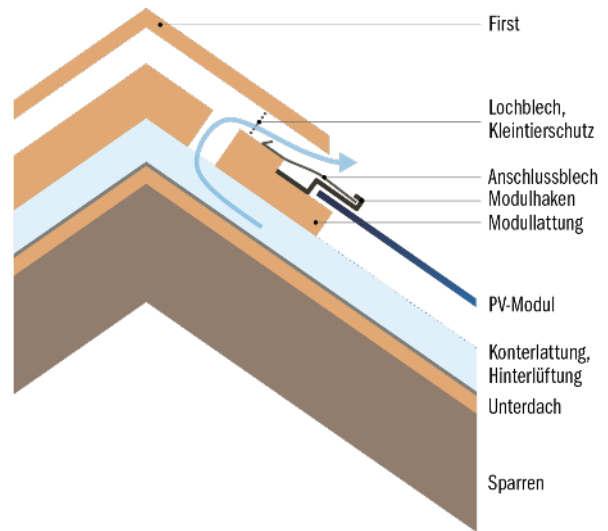

Quelle: Christof Bucher, Photovoltaikanlagen, Faktor Verlag 2021

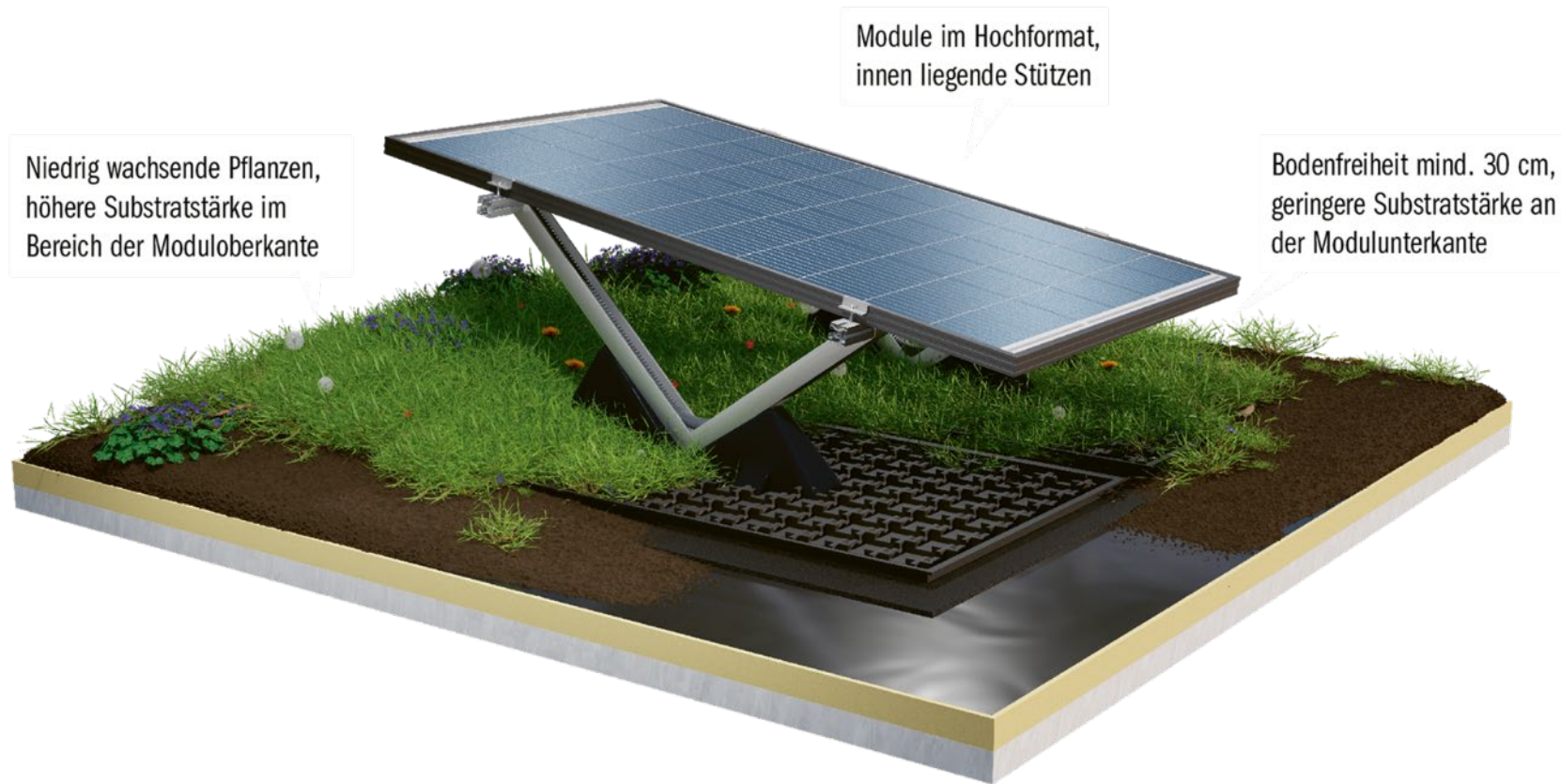

Quelle: Christof Bucher, Photovoltaikanlagen, Faktor Verlag 2021



Quelle: Christof Bucher, Photovoltaikanlagen, Faktor Verlag 2021

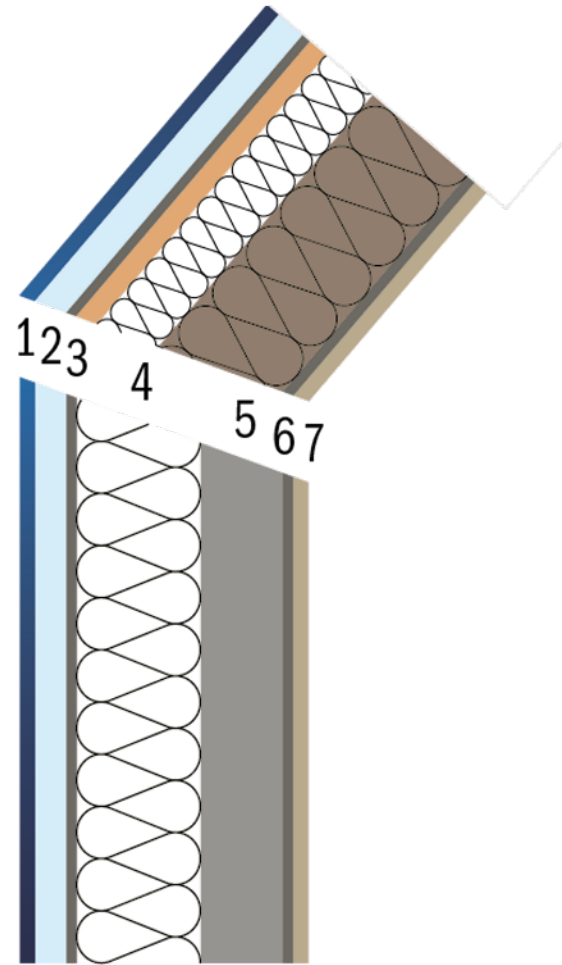

Quelle: Christof Bucher, Photovoltaikanlagen, Faktor Verlag 2021

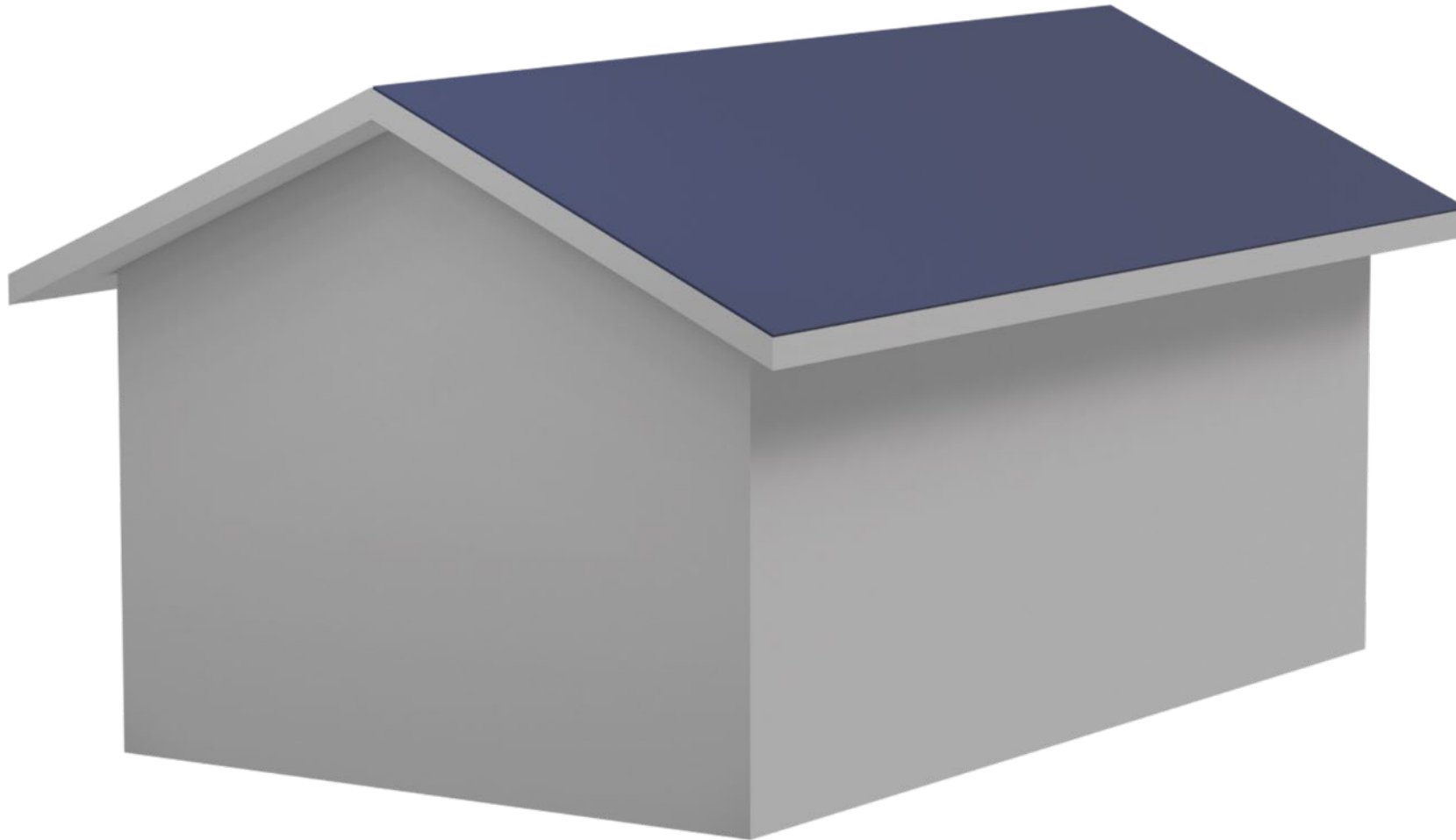

Quelle: Christof Bucher, Photovoltaikanlagen, Faktor Verlag 2021

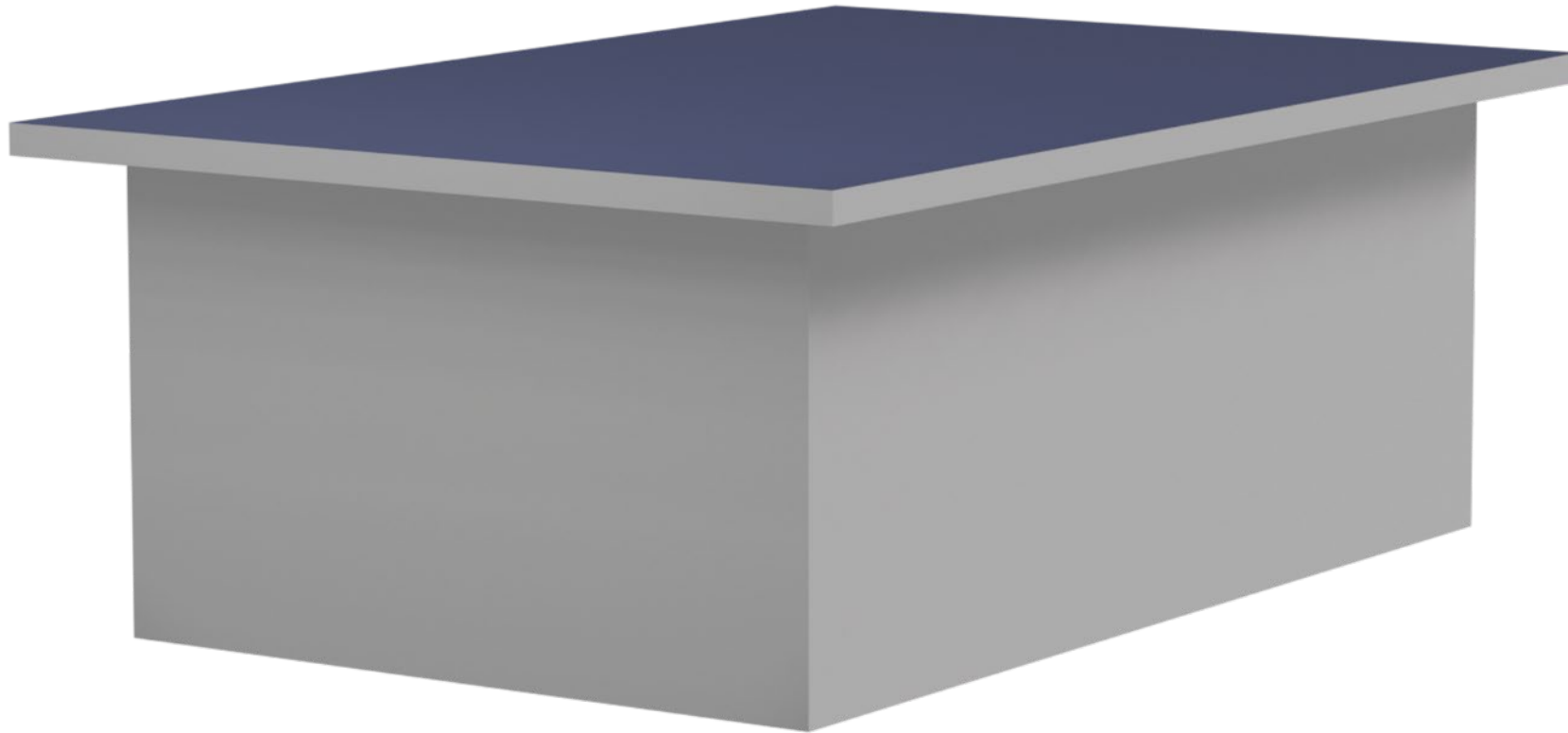

Quelle: Christof Bucher, Photovoltaikanlagen, Faktor Verlag 2021

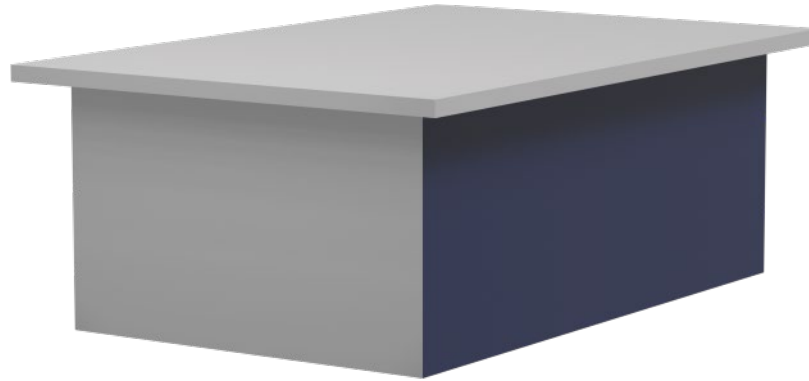

Quelle: Christof Bucher, Photovoltaikanlagen, Faktor Verlag 2021

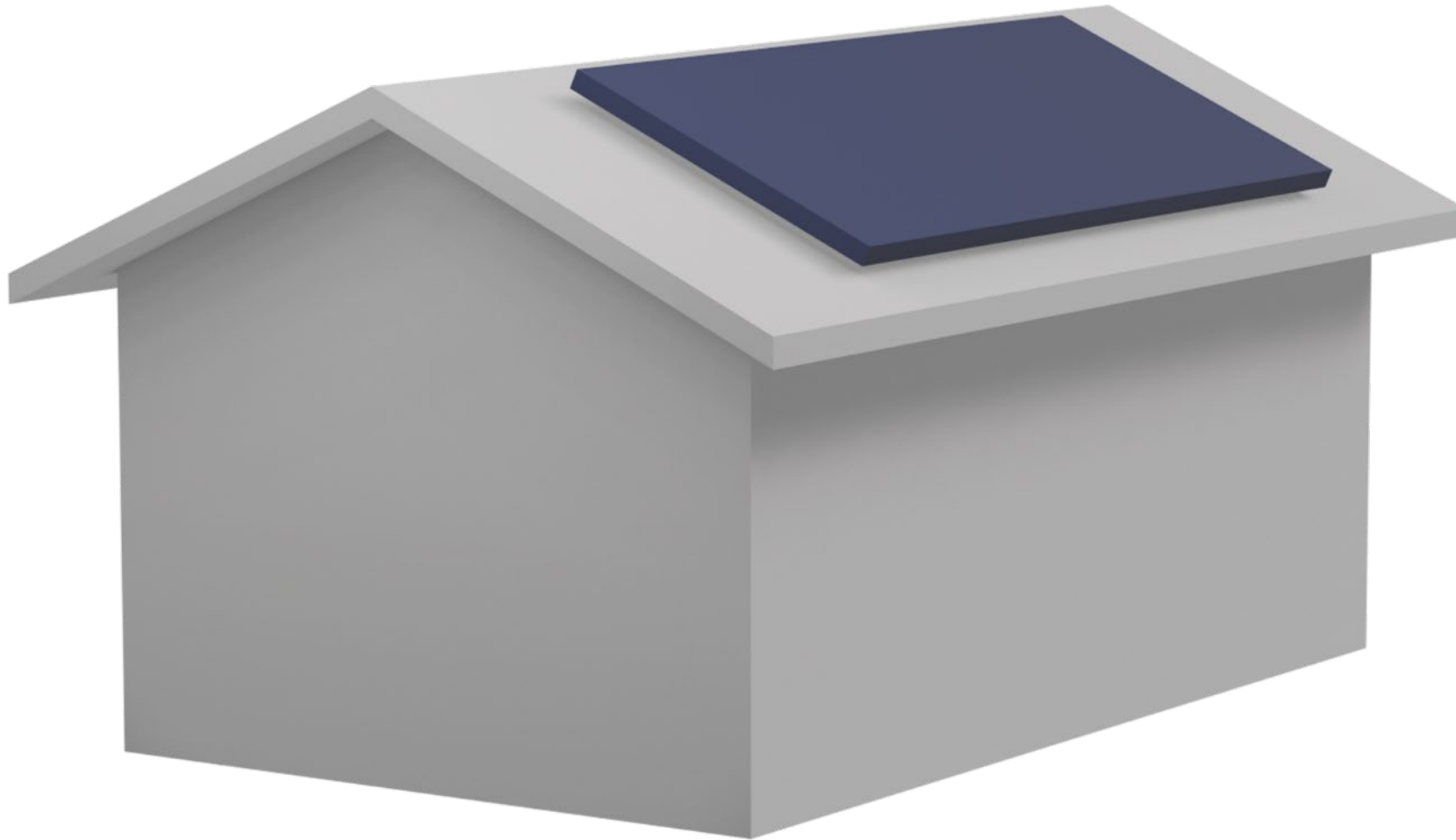

Quelle: Christof Bucher, Photovoltaikanlagen, Faktor Verlag 2021



Quelle: Christof Bucher, Photovoltaikanlagen, Faktor Verlag 2021

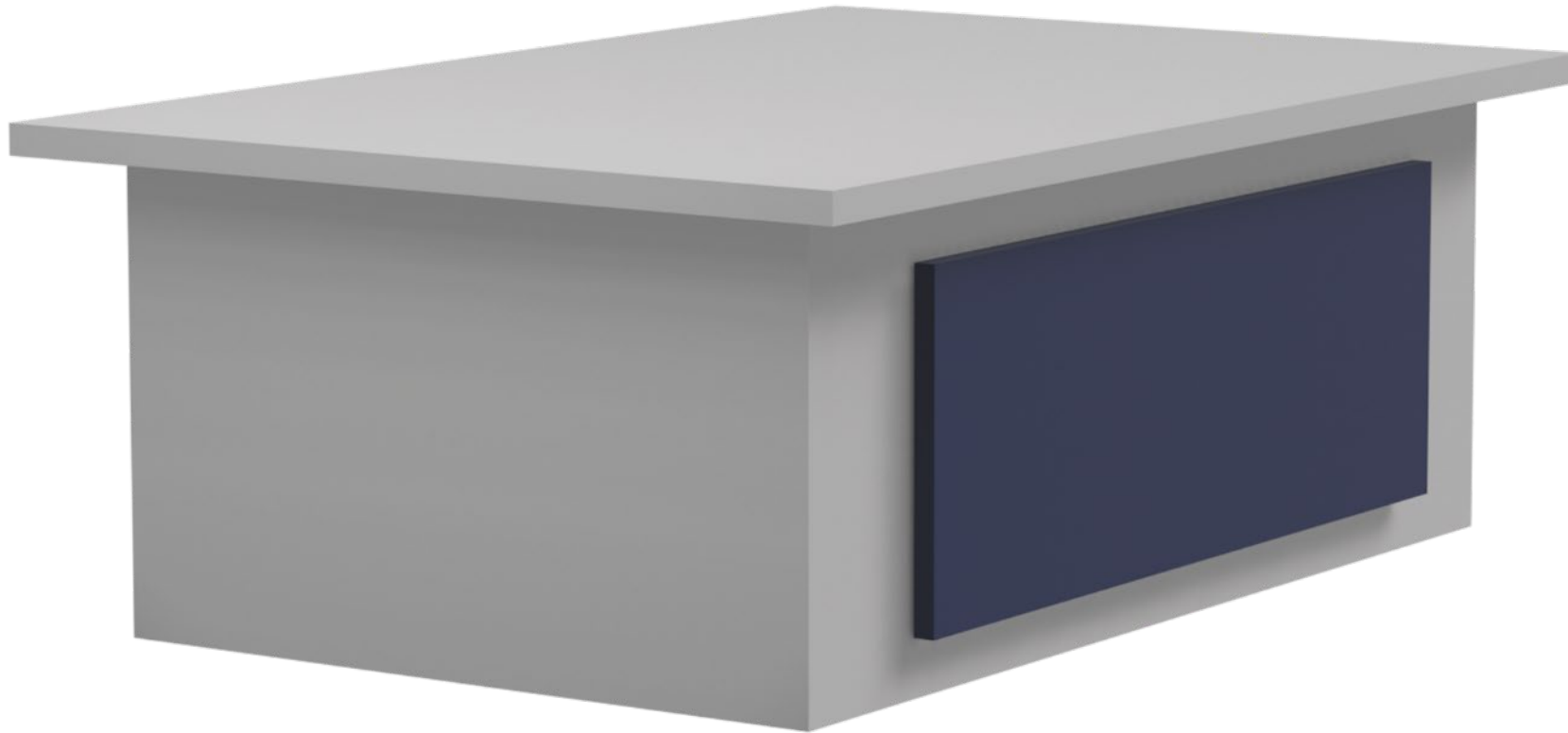

Quelle: Christof Bucher, Photovoltaikanlagen, Faktor Verlag 2021



Quelle: Christof Bucher, Photovoltaikanlagen, Faktor Verlag 2021

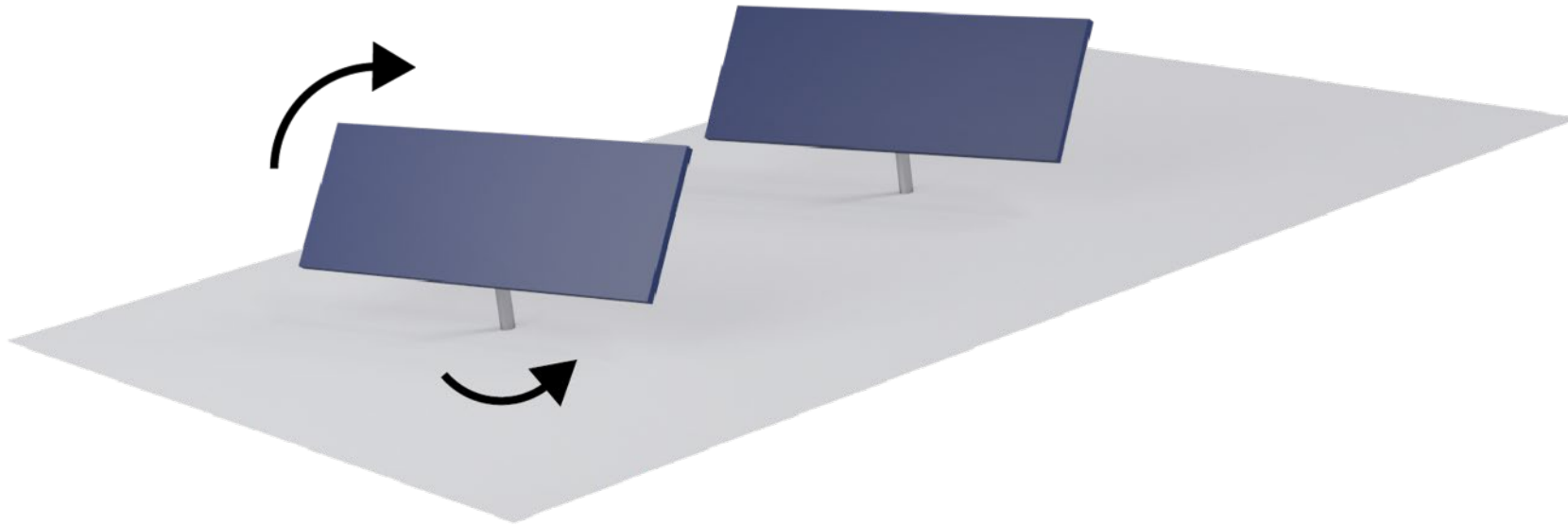

Quelle: Christof Bucher, Photovoltaikanlagen, Faktor Verlag 2021

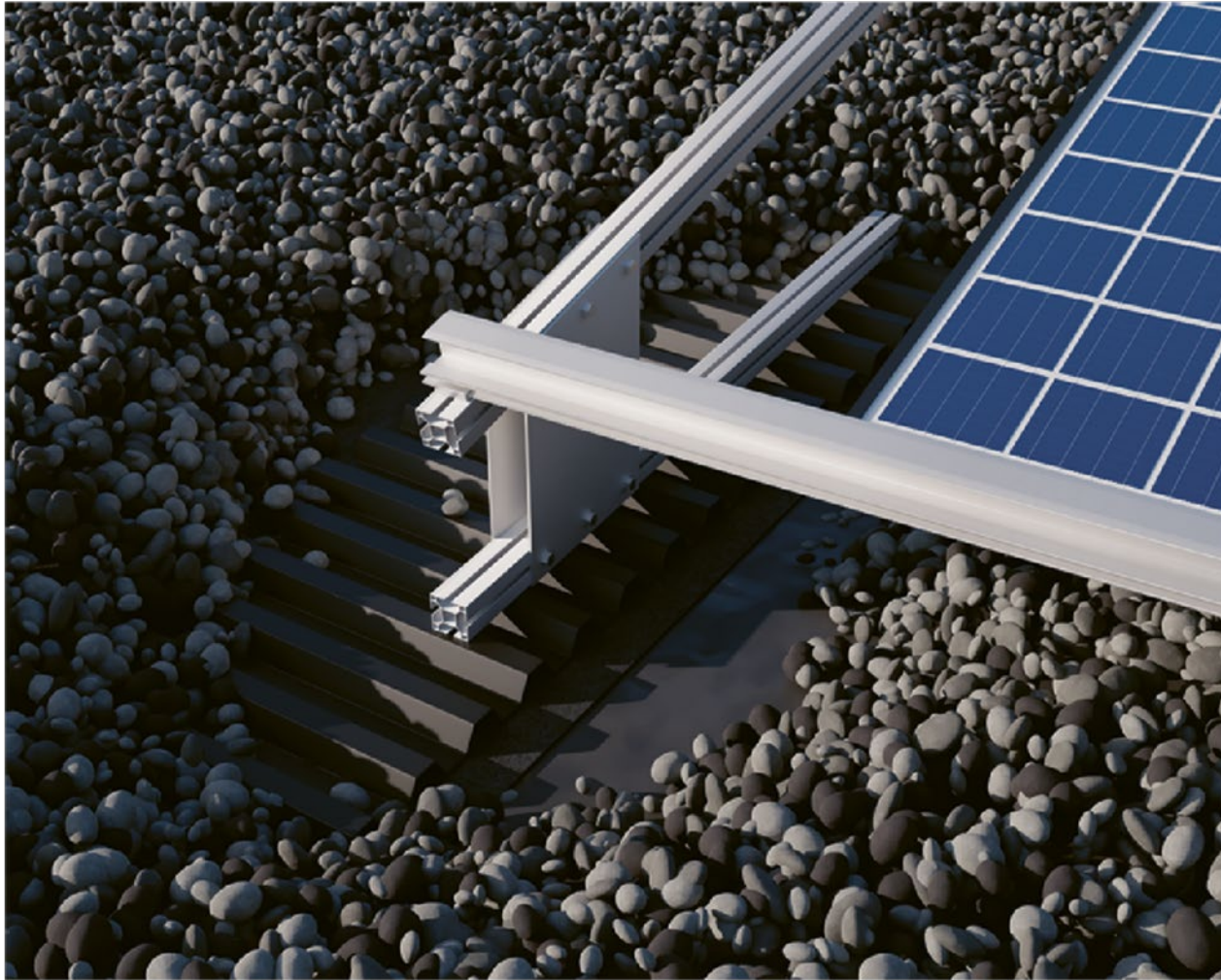

Quelle: Christof Bucher, Photovoltaikanlagen, Faktor Verlag 2021

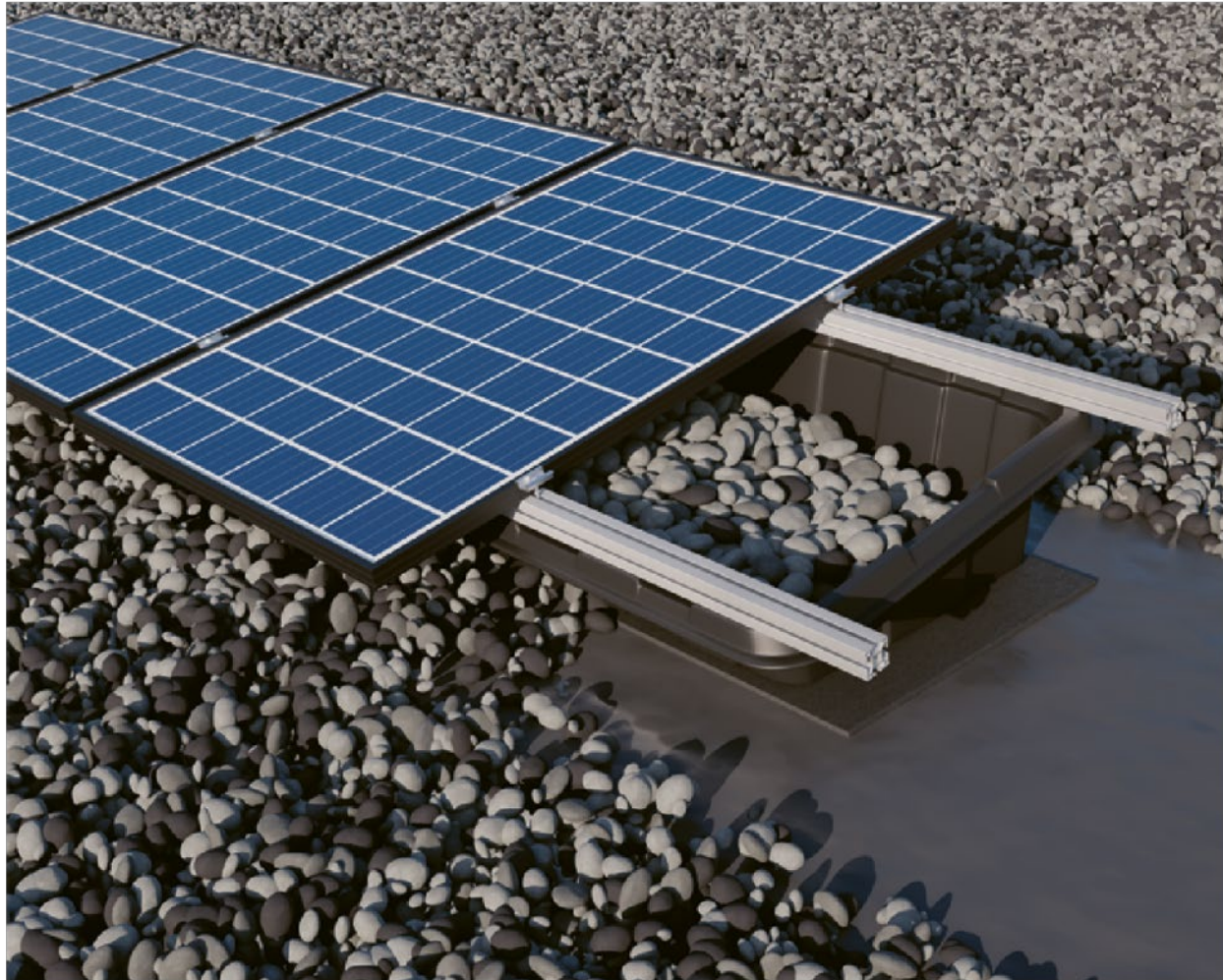

Quelle: Christof Bucher, Photovoltaikanlagen, Faktor Verlag 2021

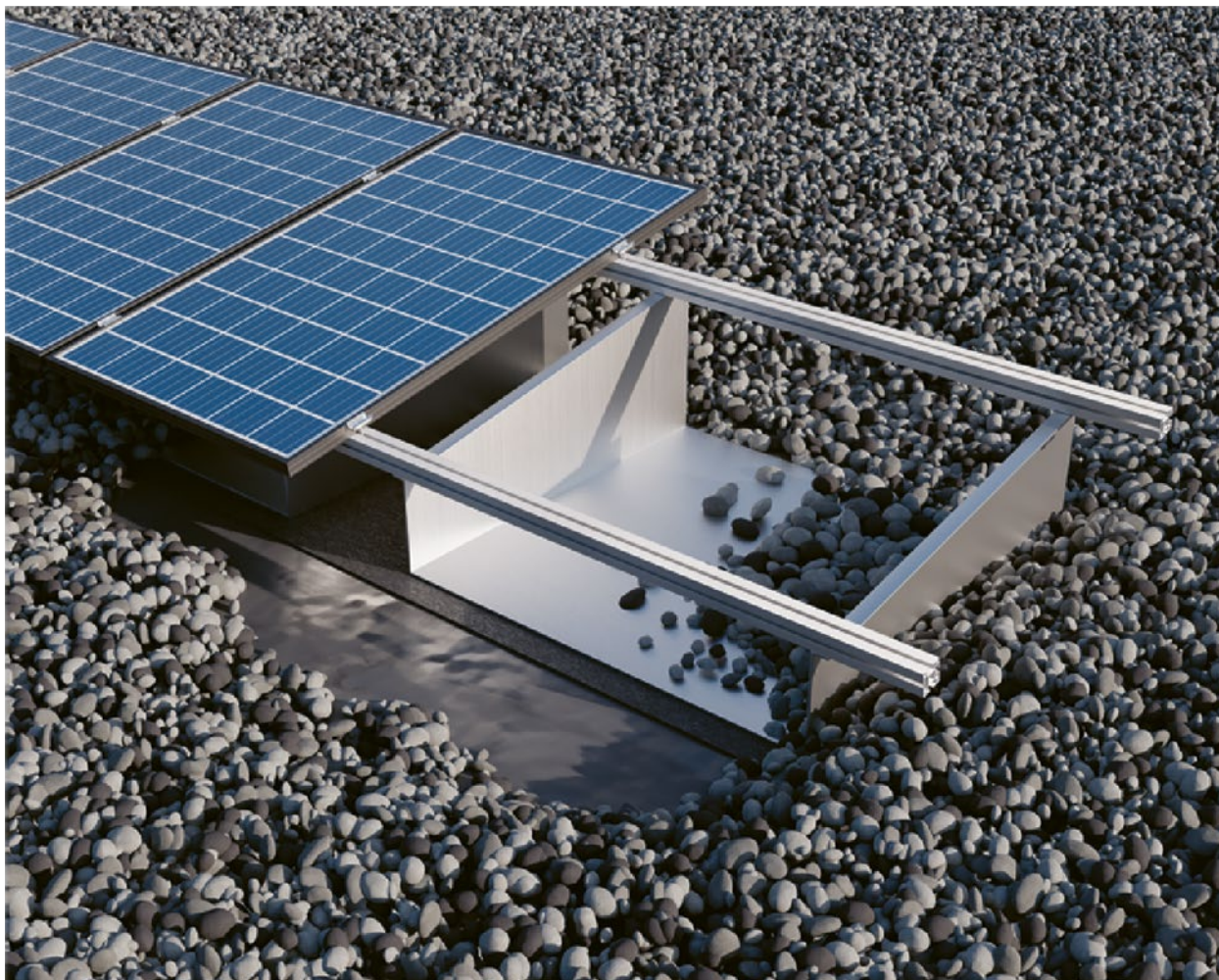

Quelle: Christof Bucher, Photovoltaikanlagen, Faktor Verlag 2021

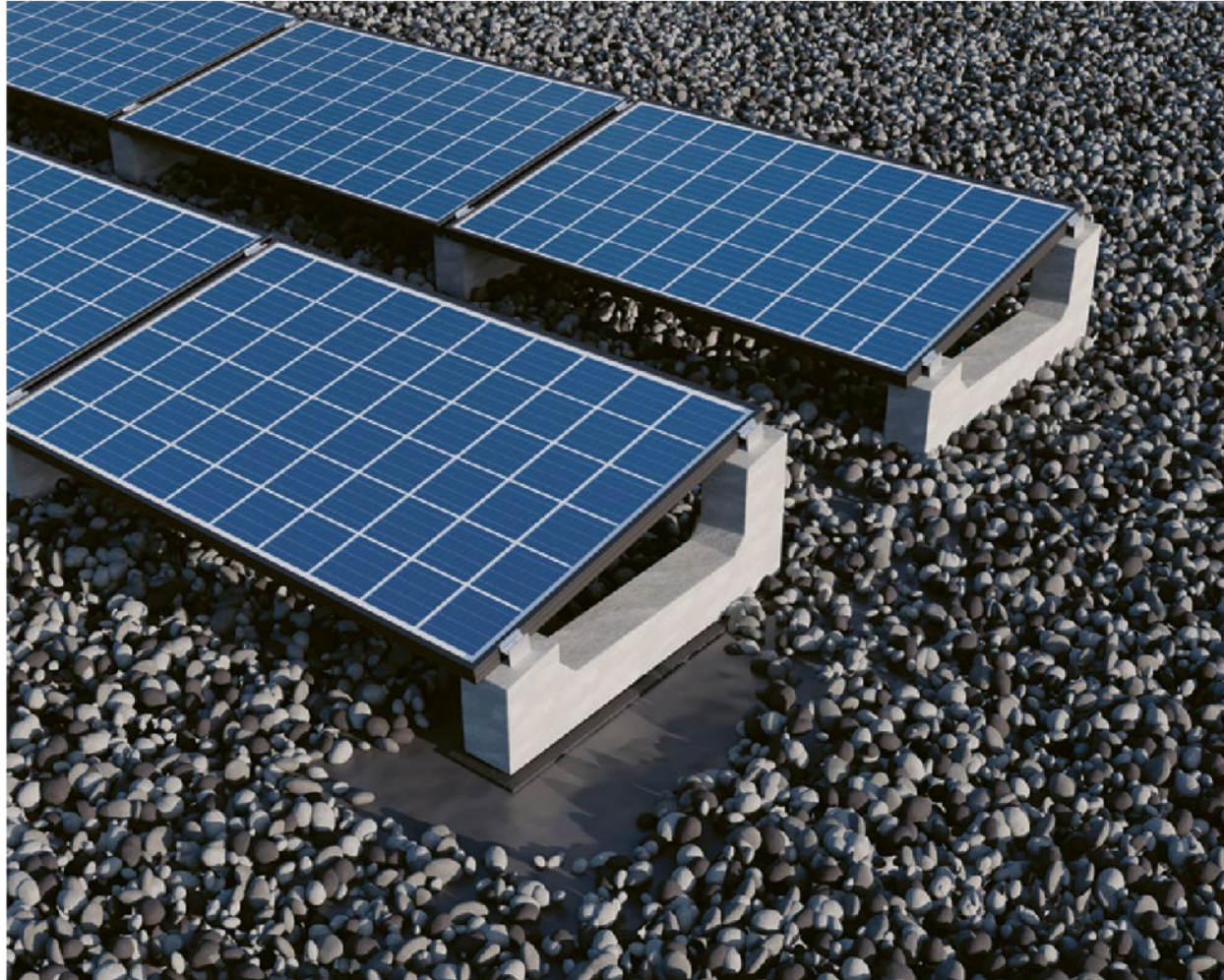

Quelle: Christof Bucher, Photovoltaikanlagen, Faktor Verlag 2021

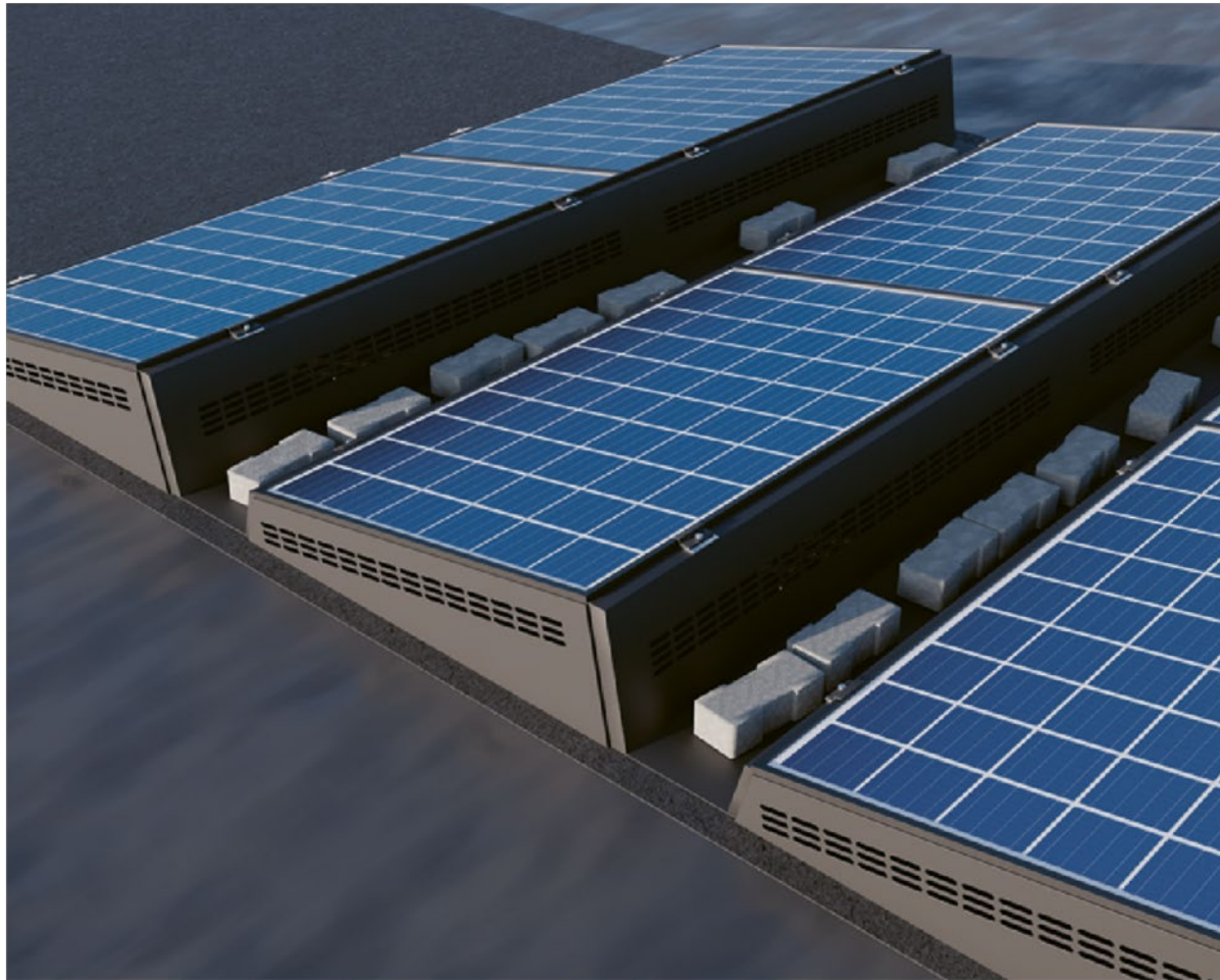

Quelle: Christof Bucher, Photovoltaikanlagen, Faktor Verlag 2021



Quelle: Christof Bucher, Photovoltaikanlagen, Faktor Verlag 2021

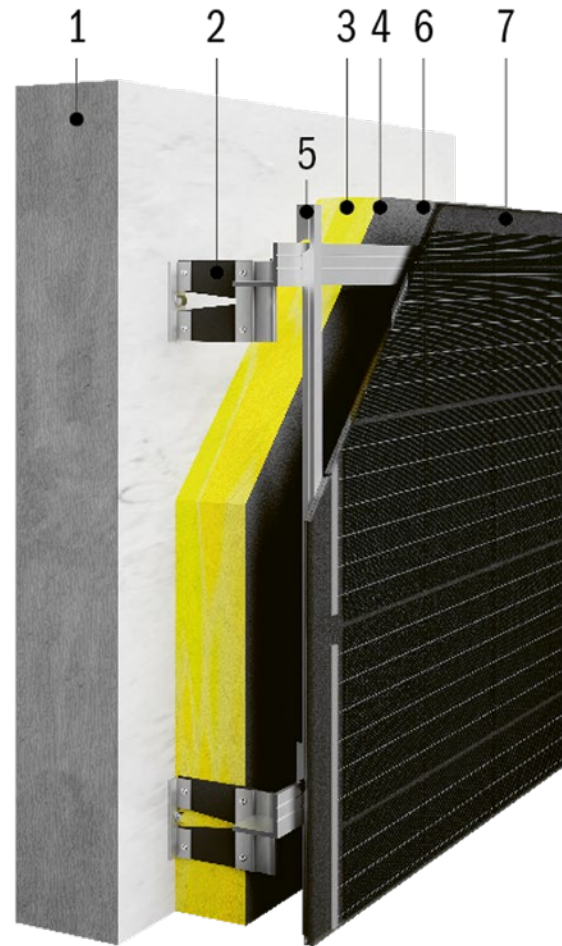

Quelle: Christof Bucher, Photovoltaikanlagen, Faktor Verlag 2021



Quelle: Christof Bucher, Photovoltaikanlagen, Faktor Verlag 2021



Quelle: Christof Bucher, Photovoltaikanlagen, Faktor Verlag 2021



Quelle: Christof Bucher, Photovoltaikanlagen, Faktor Verlag 2021



Quelle: Christof Bucher, Photovoltaikanlagen, Faktor Verlag 2021



Quelle: Christof Bucher, Photovoltaikanlagen, Faktor Verlag 2021



Quelle: Christof Bucher, Photovoltaikanlagen, Faktor Verlag 2021

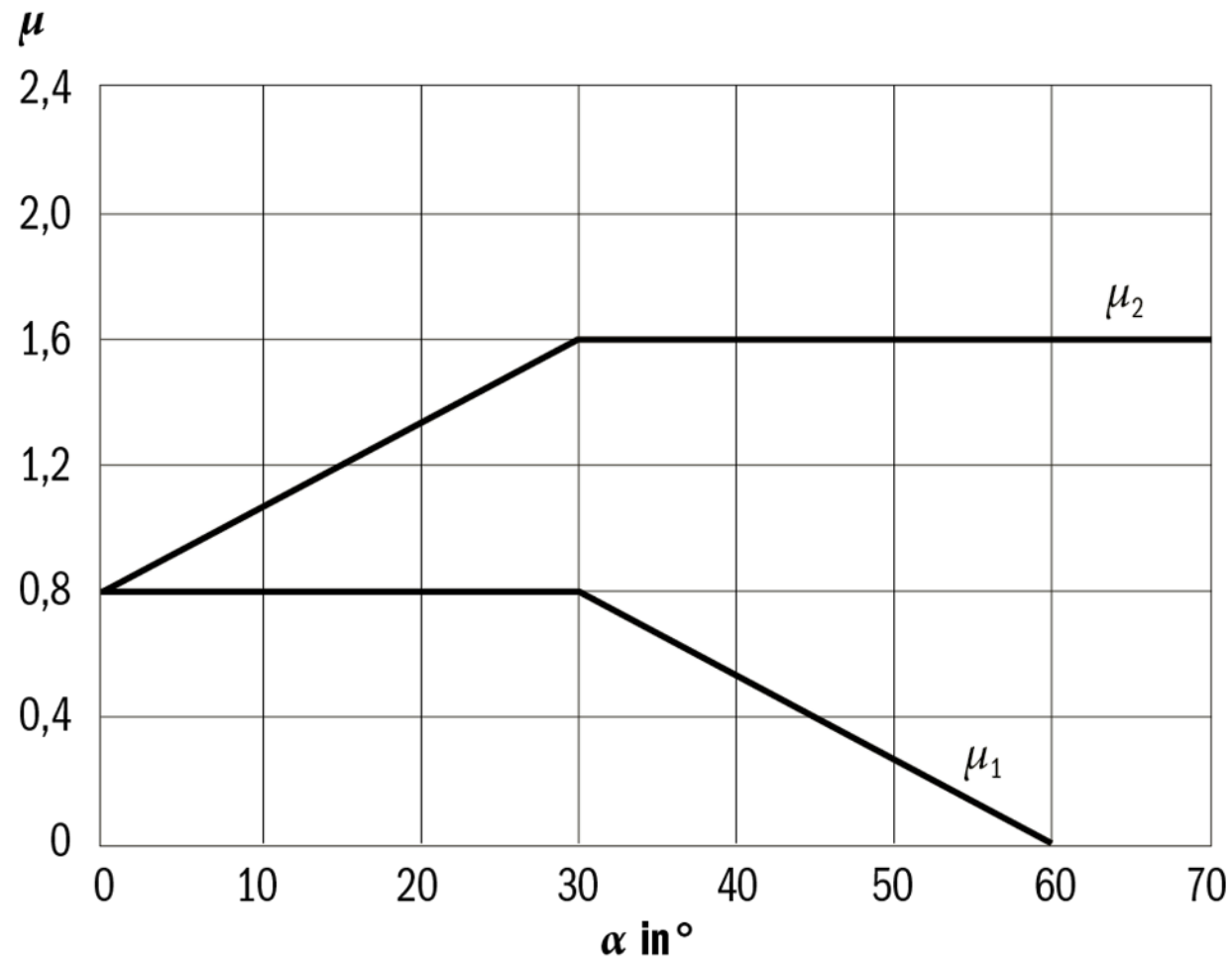

Quelle: Christof Bucher, Photovoltaikanlagen, Faktor Verlag 2021

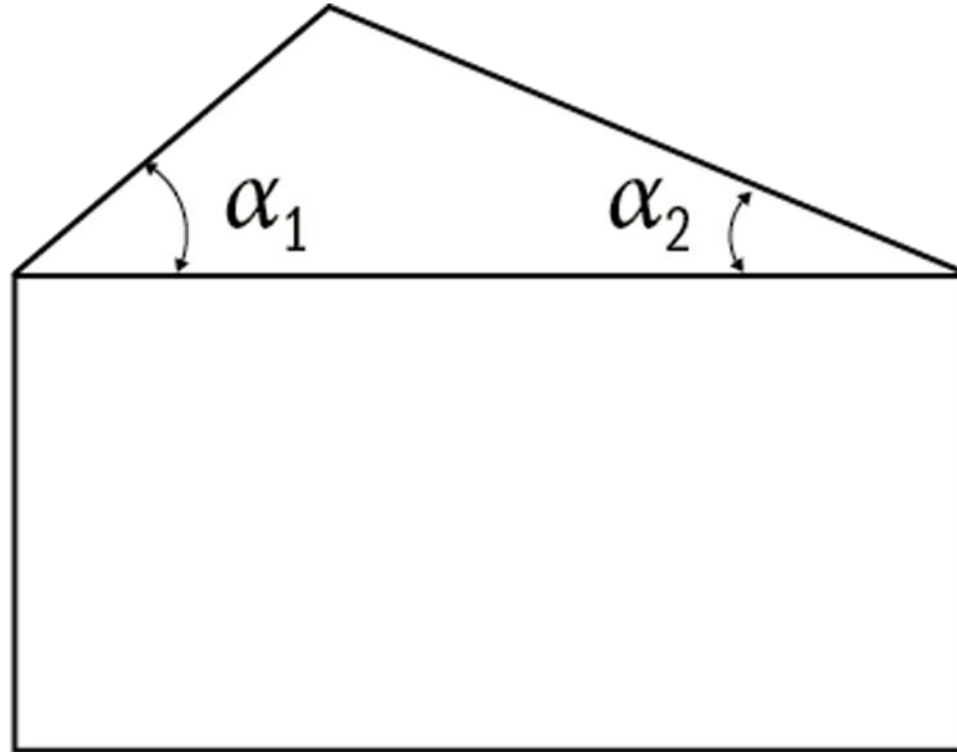

Quelle: Christof Bucher, Photovoltaikanlagen, Faktor Verlag 2021

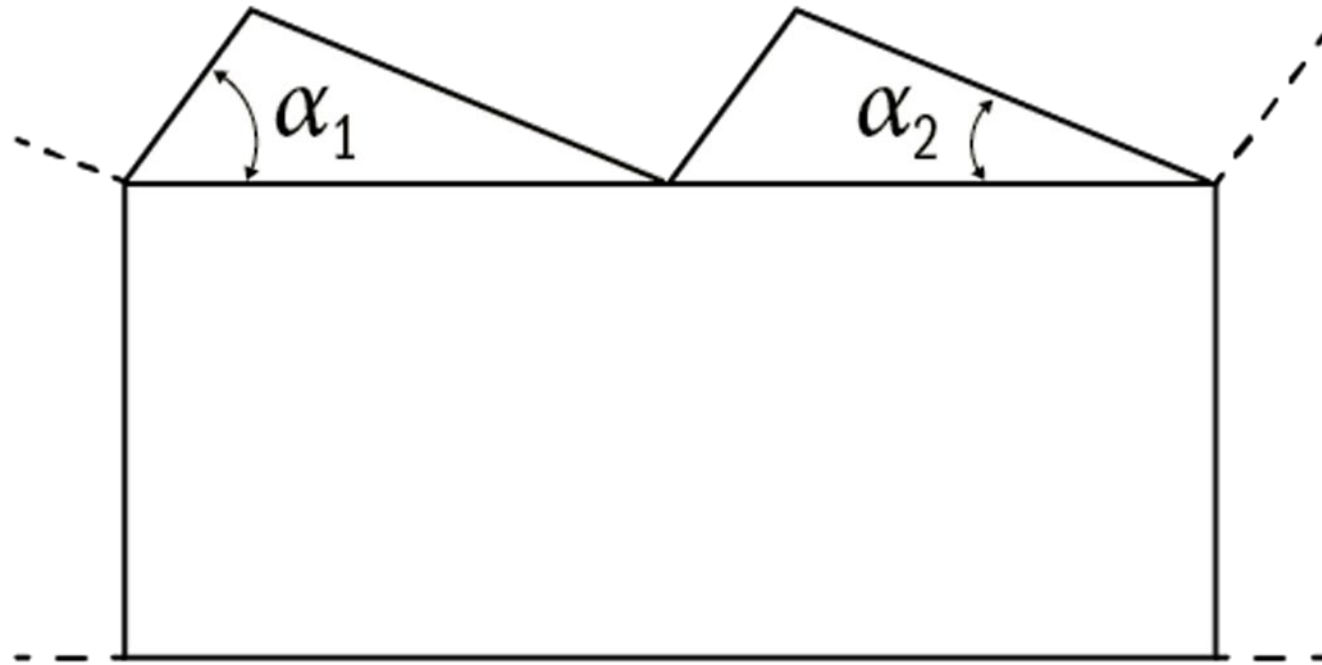

Quelle: Christof Bucher, Photovoltaikanlagen, Faktor Verlag 2021

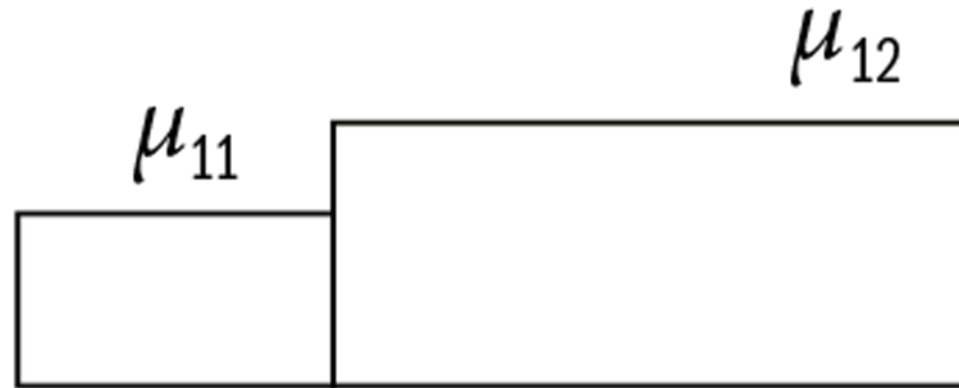

Quelle: Christof Bucher, Photovoltaikanlagen, Faktor Verlag 2021

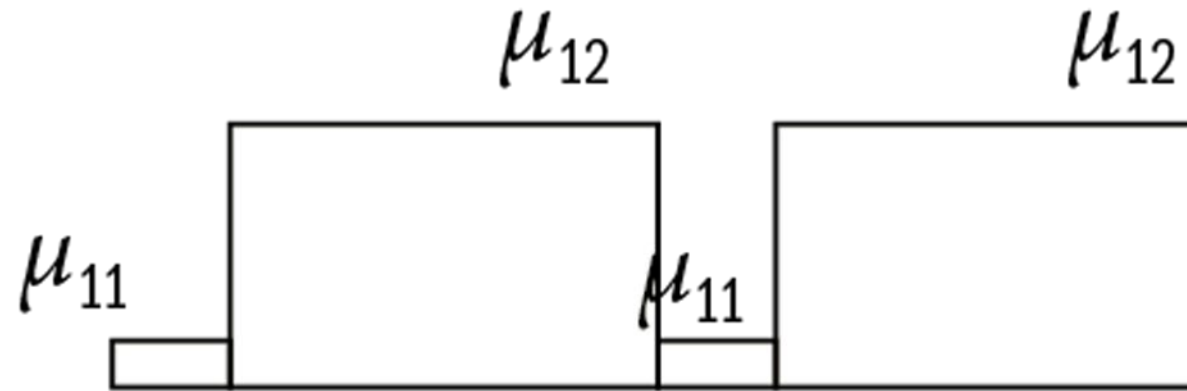

Quelle: Christof Bucher, Photovoltaikanlagen, Faktor Verlag 2021

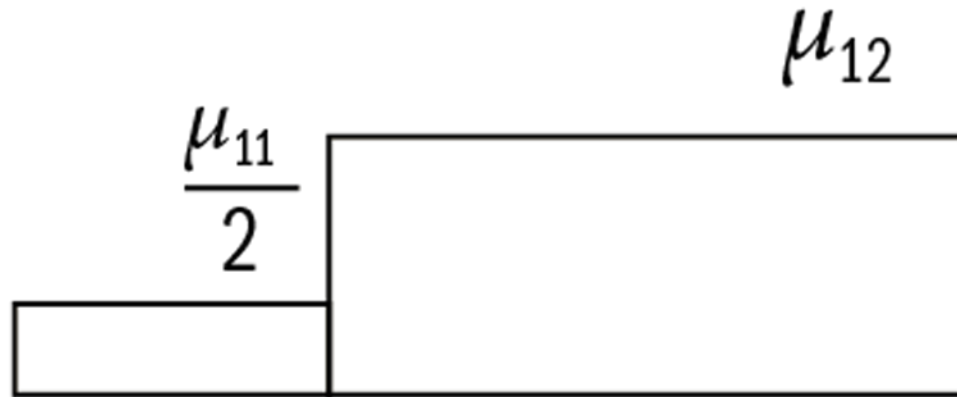

Quelle: Christof Bucher, Photovoltaikanlagen, Faktor Verlag 2021

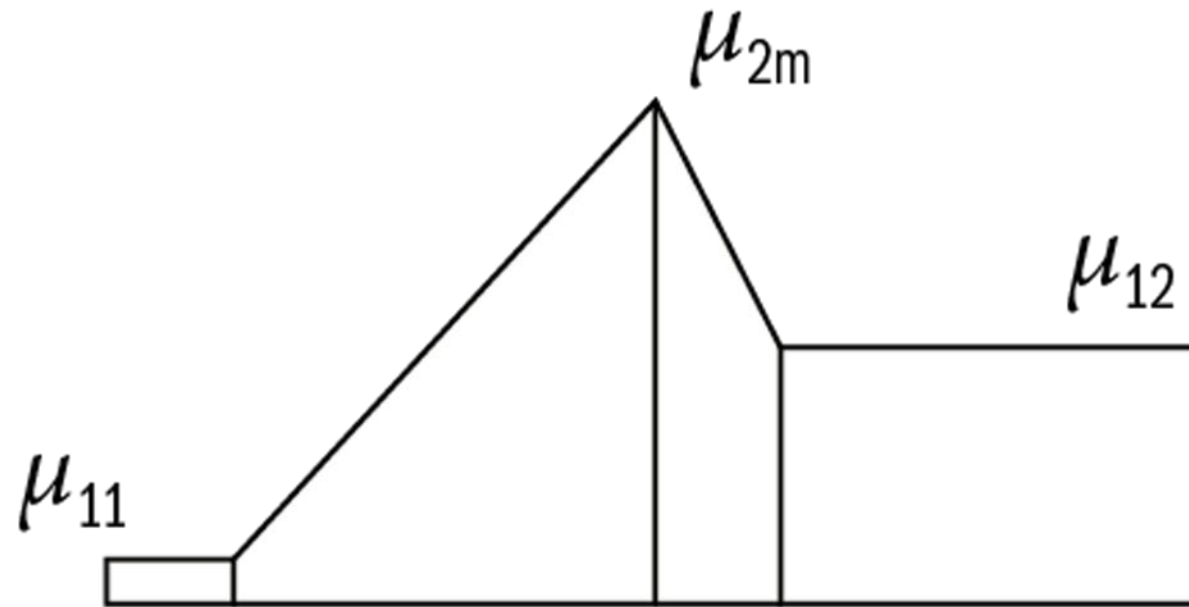

Quelle: Christof Bucher, Photovoltaikanlagen, Faktor Verlag 2021



Quelle: Christof Bucher, Photovoltaikanlagen, Faktor Verlag 2021

$$\mu_{11} = \mu_1(\alpha_1) \quad \mu_{12} = \mu_1(\alpha_2)$$

Quelle: Christof Bucher, Photovoltaikanlagen, Faktor Verlag 2021

$$\mu_{2m} = \mu_2 \cdot \left(\frac{\alpha_1 + \alpha_2}{2} \right)$$

Quelle: Christof Bucher, Photovoltaikanlagen, Faktor Verlag 2021

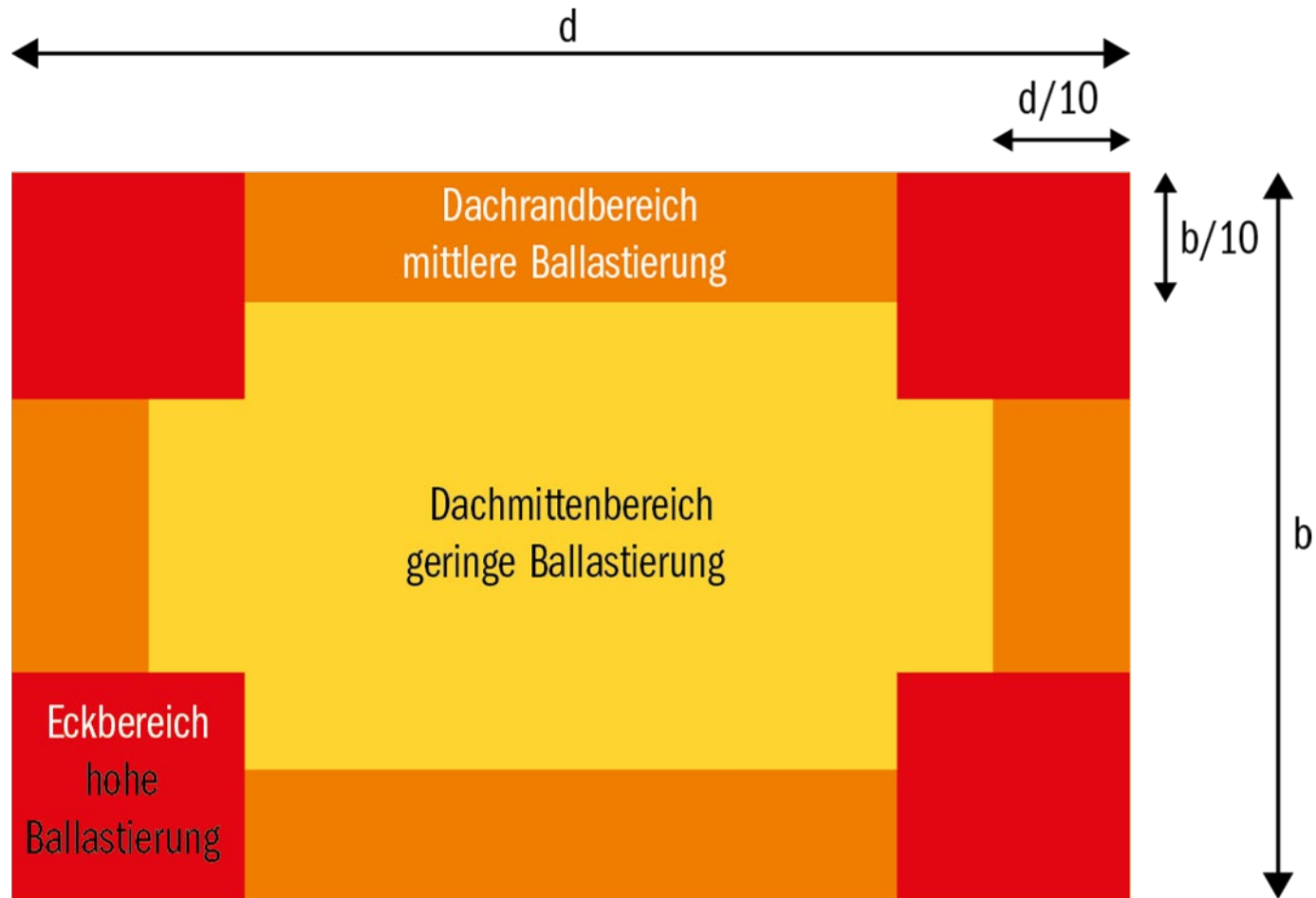

Quelle: Christof Bucher, Photovoltaikanlagen, Faktor Verlag 2021

Gebäudehöhe z in m

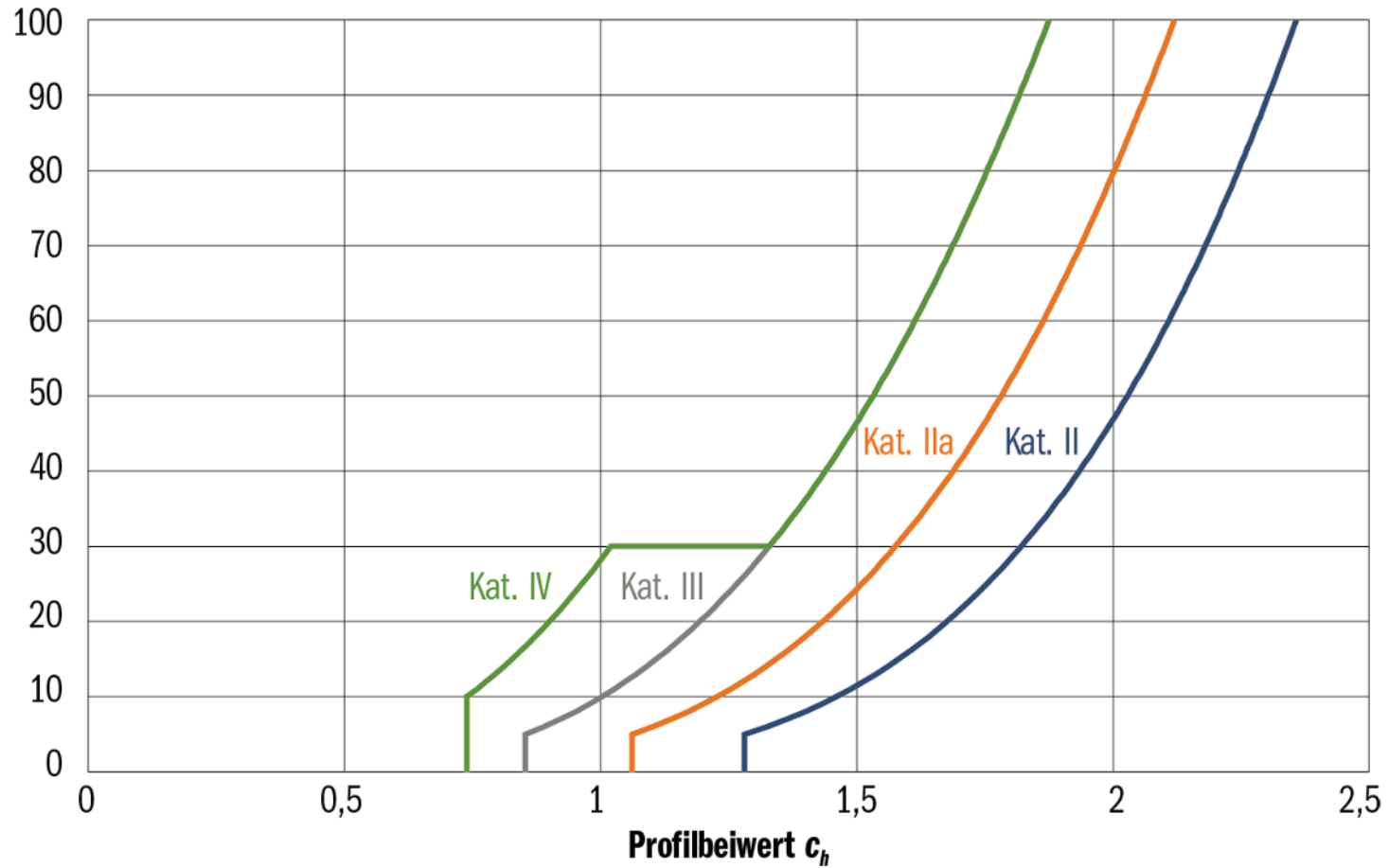

Quelle: Christof Bucher, Photovoltaikanlagen, Faktor Verlag 2021

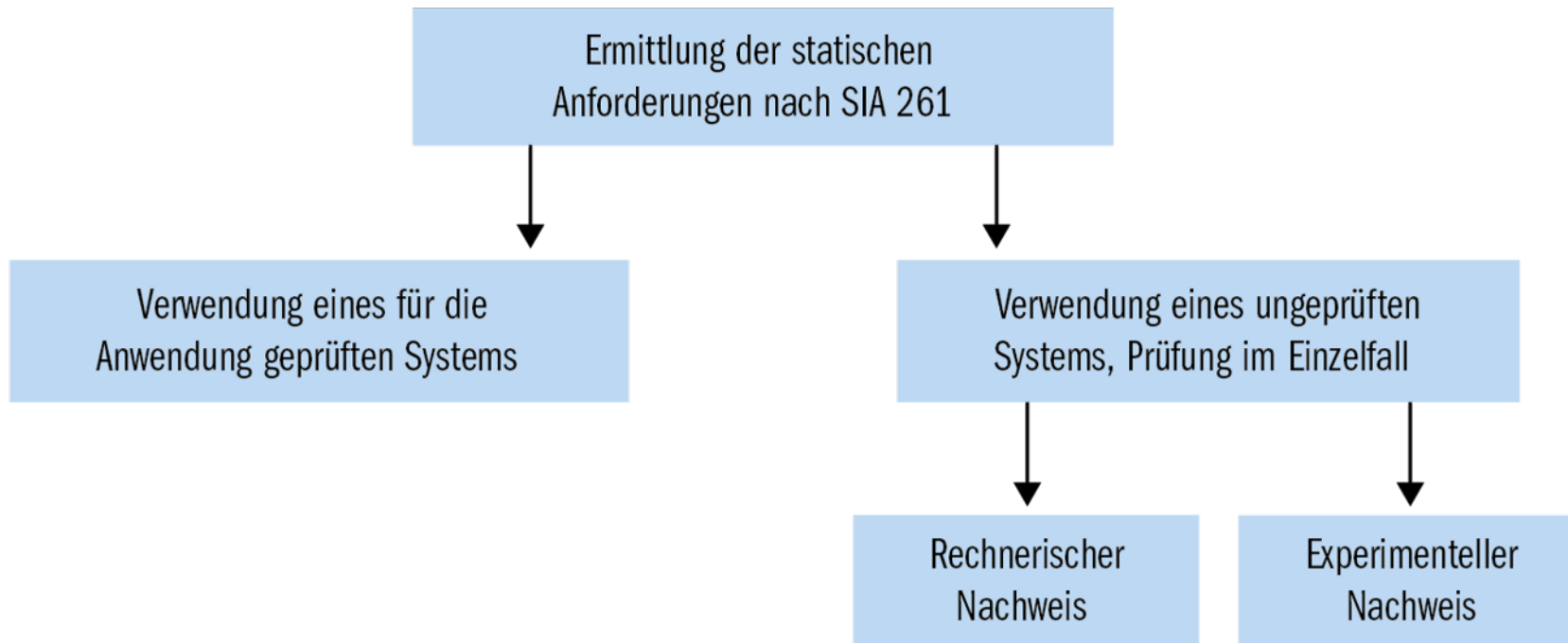

Quelle: Christof Bucher, Photovoltaikanlagen, Faktor Verlag 2021

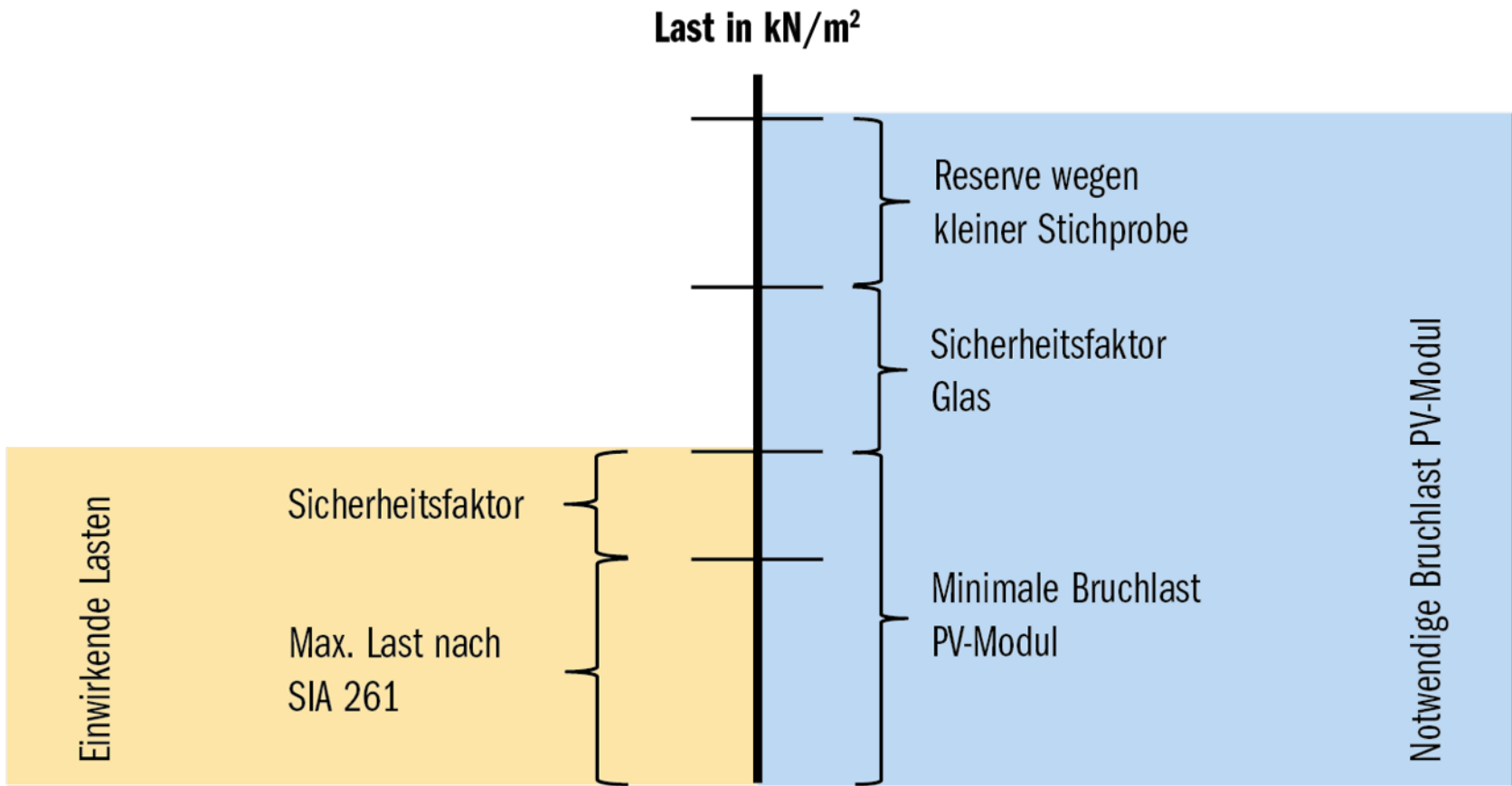

Quelle: Christof Bucher, Photovoltaikanlagen, Faktor Verlag 2021



Quelle: Christof Bucher, Photovoltaikanlagen, Faktor Verlag 2021



Quelle: Christof Bucher, Photovoltaikanlagen, Faktor Verlag 2021

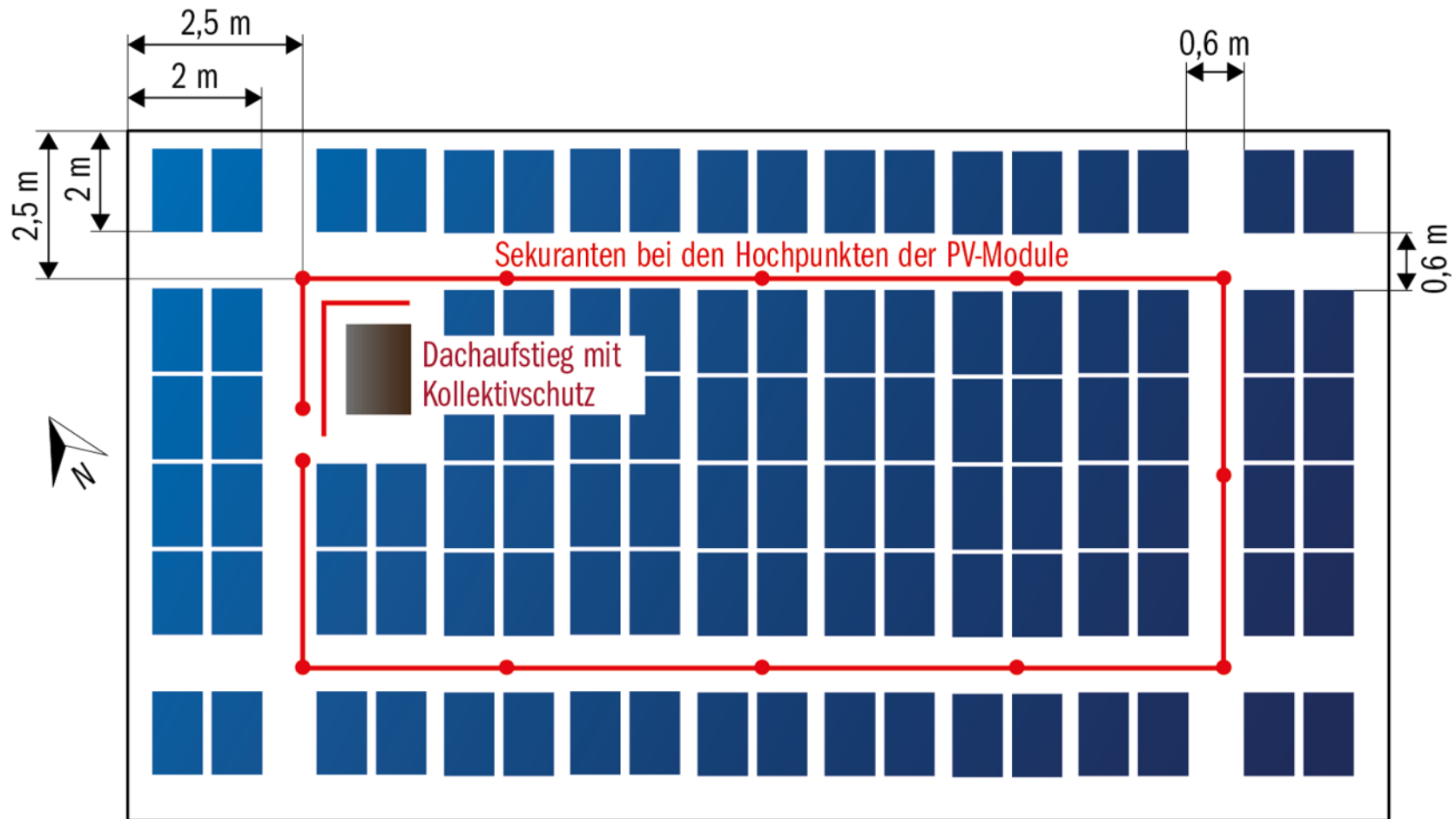

Quelle: Christof Bucher, Photovoltaikanlagen, Faktor Verlag 2021

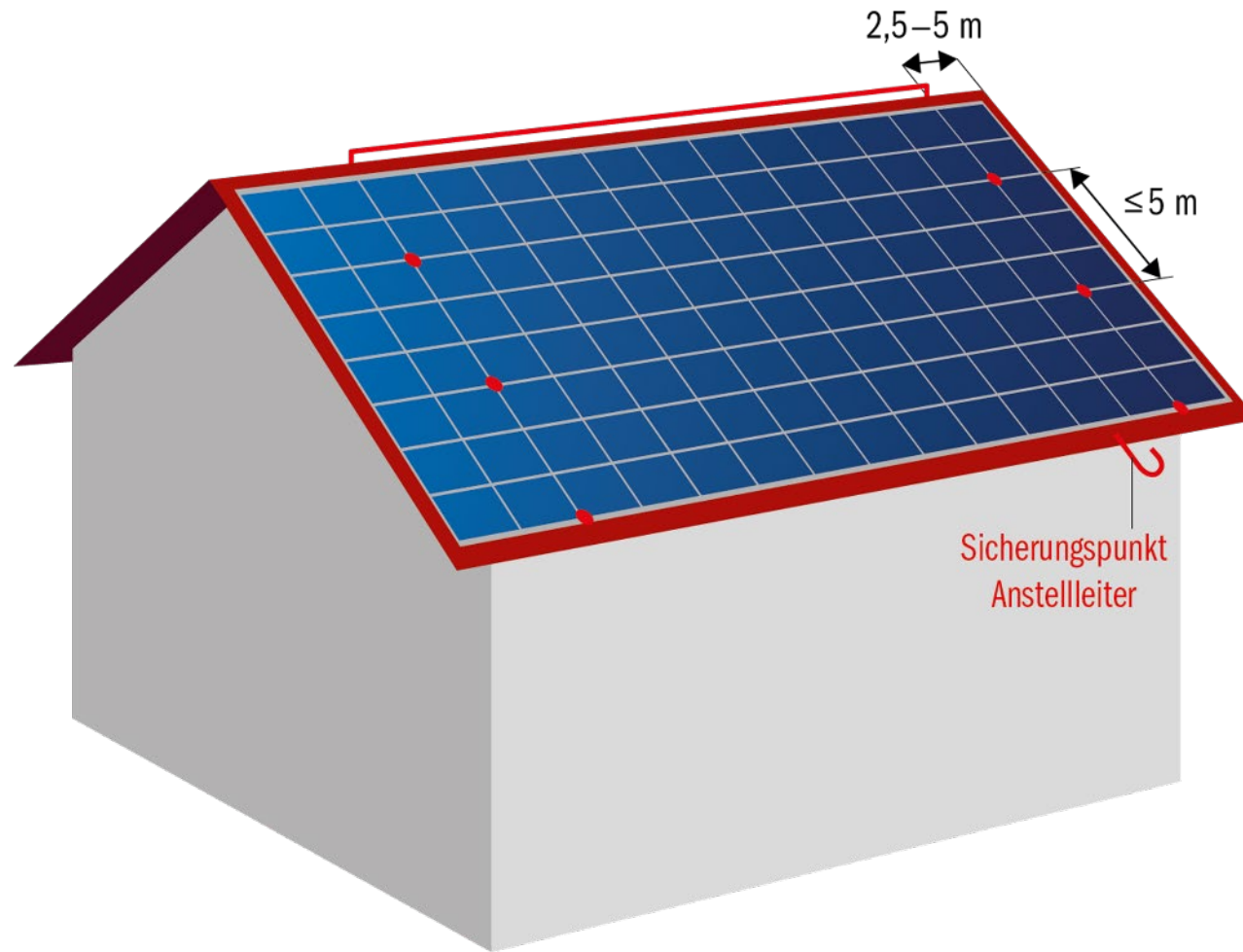

Quelle: Christof Bucher, Photovoltaikanlagen, Faktor Verlag 2021

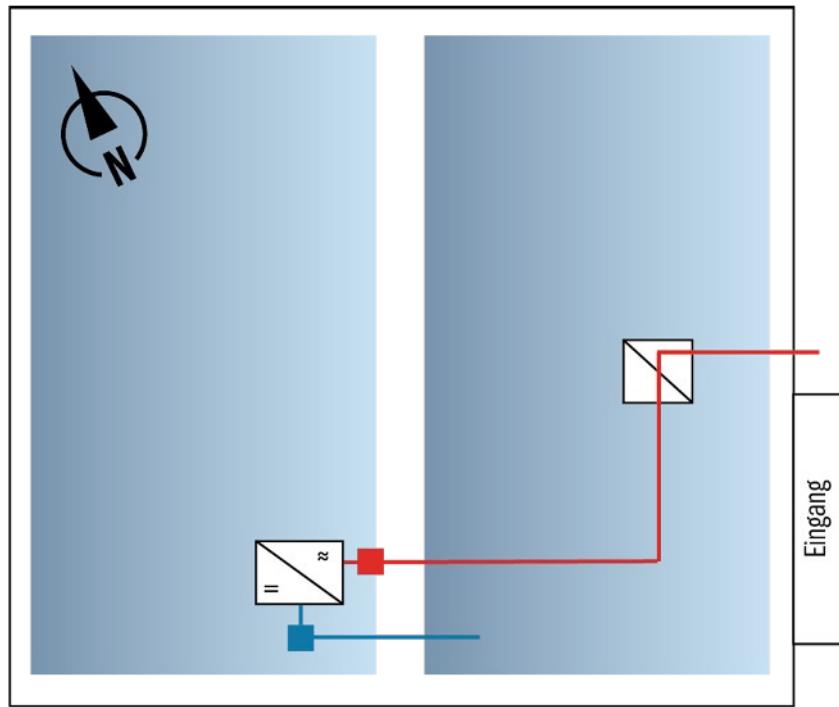

Grundriss

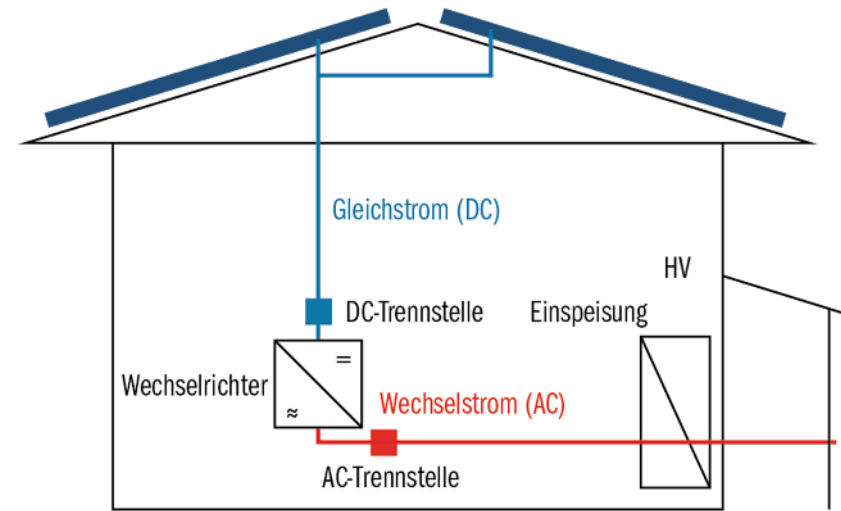

Ansicht Süd

Quelle: Christof Bucher, Photovoltaikanlagen, Faktor Verlag 2021

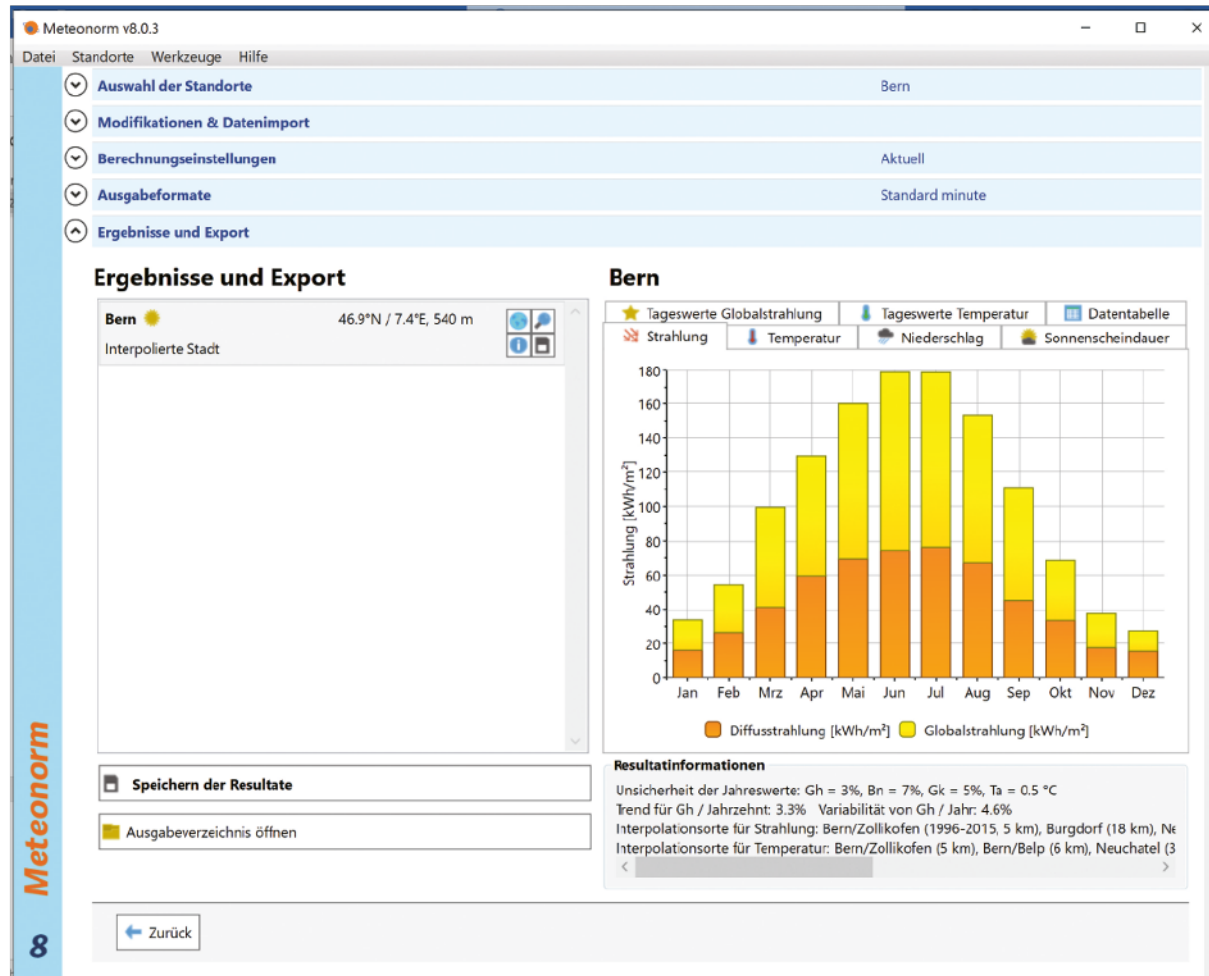

Quelle: Christof Bucher, Photovoltaikanlagen, Faktor Verlag 2021

Legal notice | Cookies | Contact | English (en)

PHOTOVOLTAIC GEOGRAPHICAL INFORMATION SYSTEM

European Commission

European Commission > EU Science Hub > PVGIS > Interactive tools

Home Tools Downloads Documentation Contact us

Cursor:
Selected: 46.952, 7.386
Elevation (m): 560

Use terrain shadows:
 Calculated horizon
 Upload horizon file

Download buttons: [csv](#) [json](#)
 Search: Keine Datei ausgewählt.

MONTHLY IRRADIATION DATA

Solar radiation database:

Start year: End year:

Irradiation:
 Global horizontal irradiation
 Direct Normal Irradiation
 Global irradiation optimum angle
 Global irradiation at angle:

Ratio:
 Diffuse/global ratio

Temperature:
 Average temperature

Buttons: [Visualize results](#) [csv](#) [json](#)

Address: [Go!](#) Lat/Lon: [Go!](#)

Quelle: Christof Bucher, Photovoltaikanlagen, Faktor Verlag 2021



Quelle: Christof Bucher, Photovoltaikanlagen, Faktor Verlag 2021

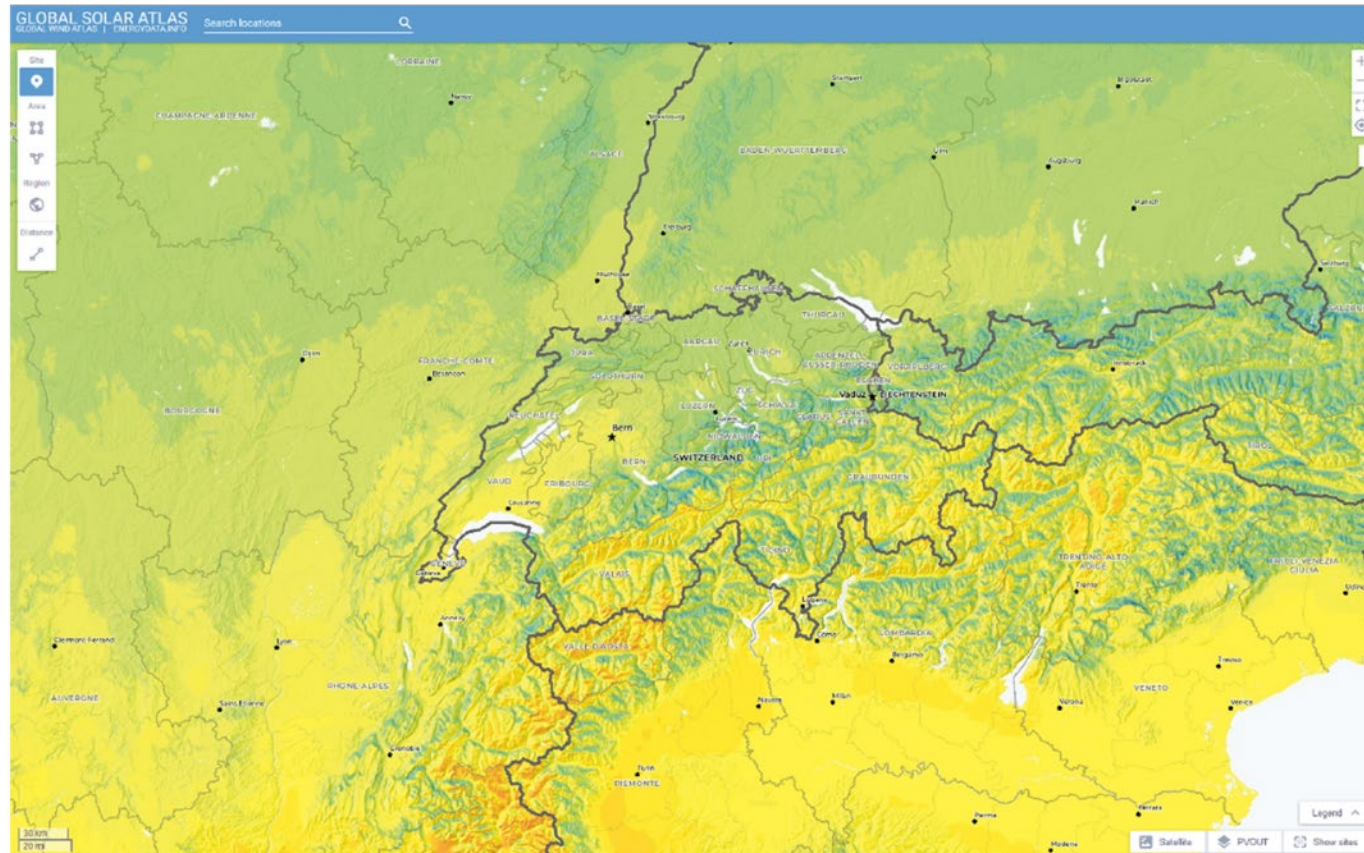

Quelle: Christof Bucher, Photovoltaikanlagen, Faktor Verlag 2021

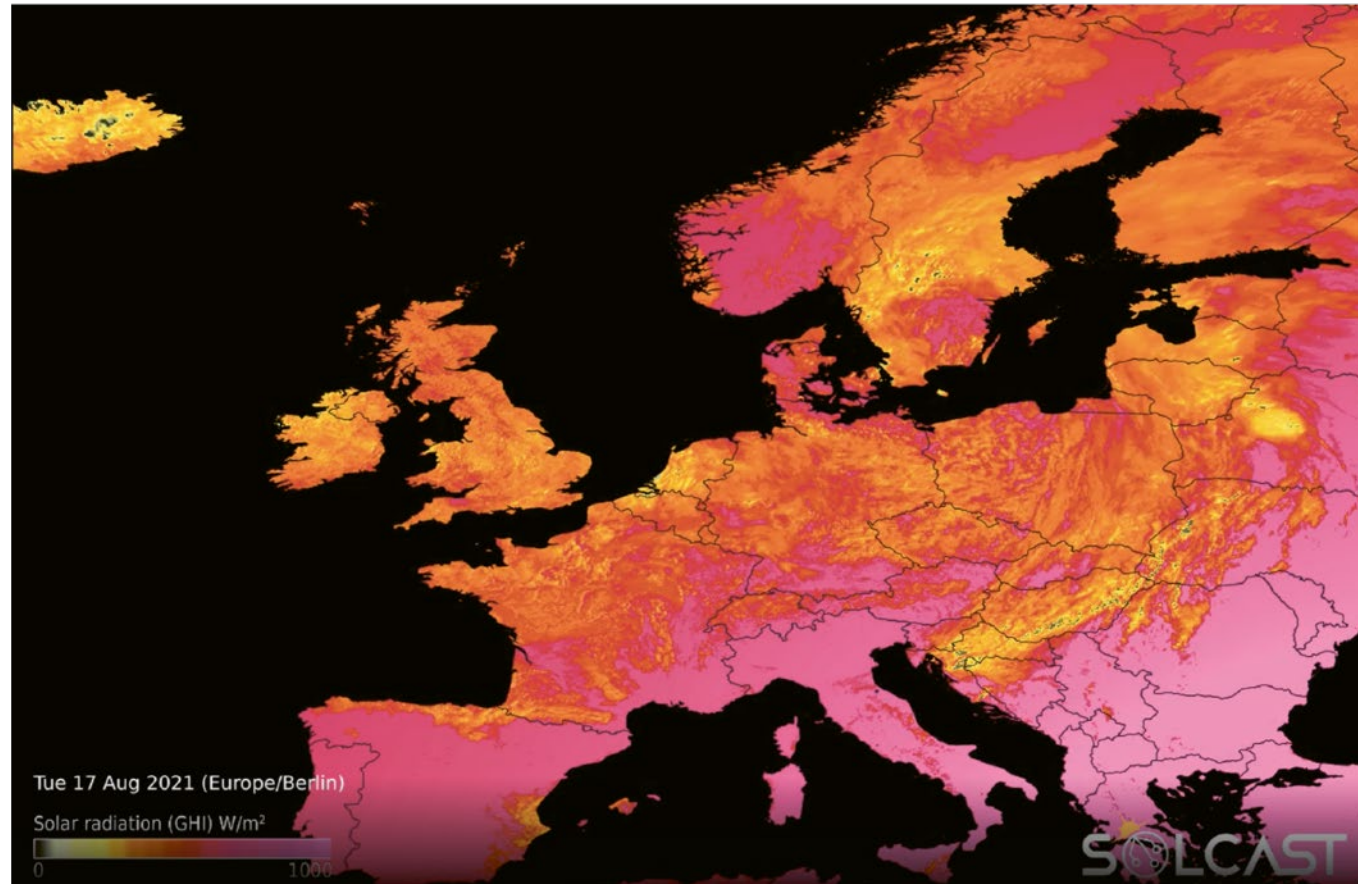

Quelle: Christof Bucher, Photovoltaikanlagen, Faktor Verlag 2021



Quelle: Christof Bucher, Photovoltaikanlagen, Faktor Verlag 2021

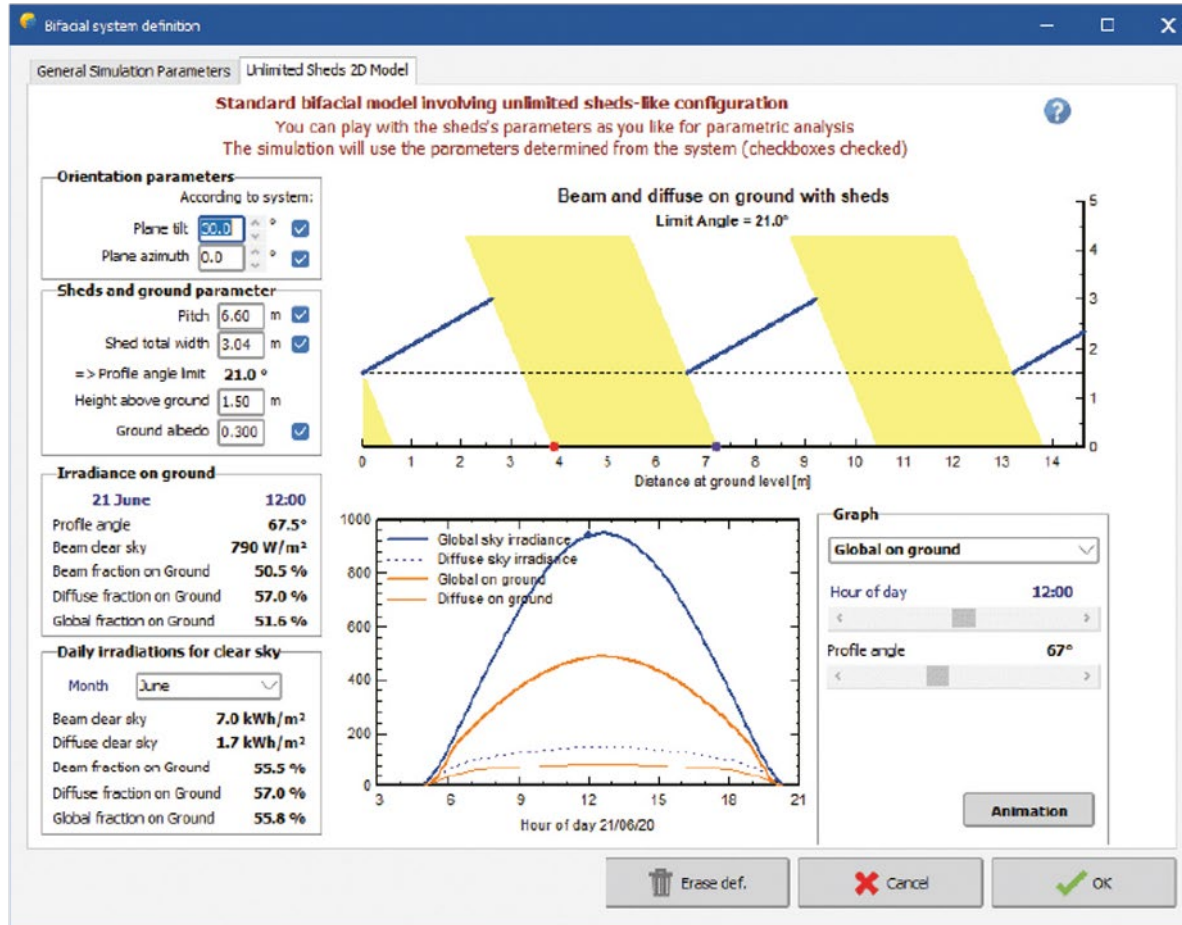

Quelle: Christof Bucher, Photovoltaikanlagen, Faktor Verlag 2021

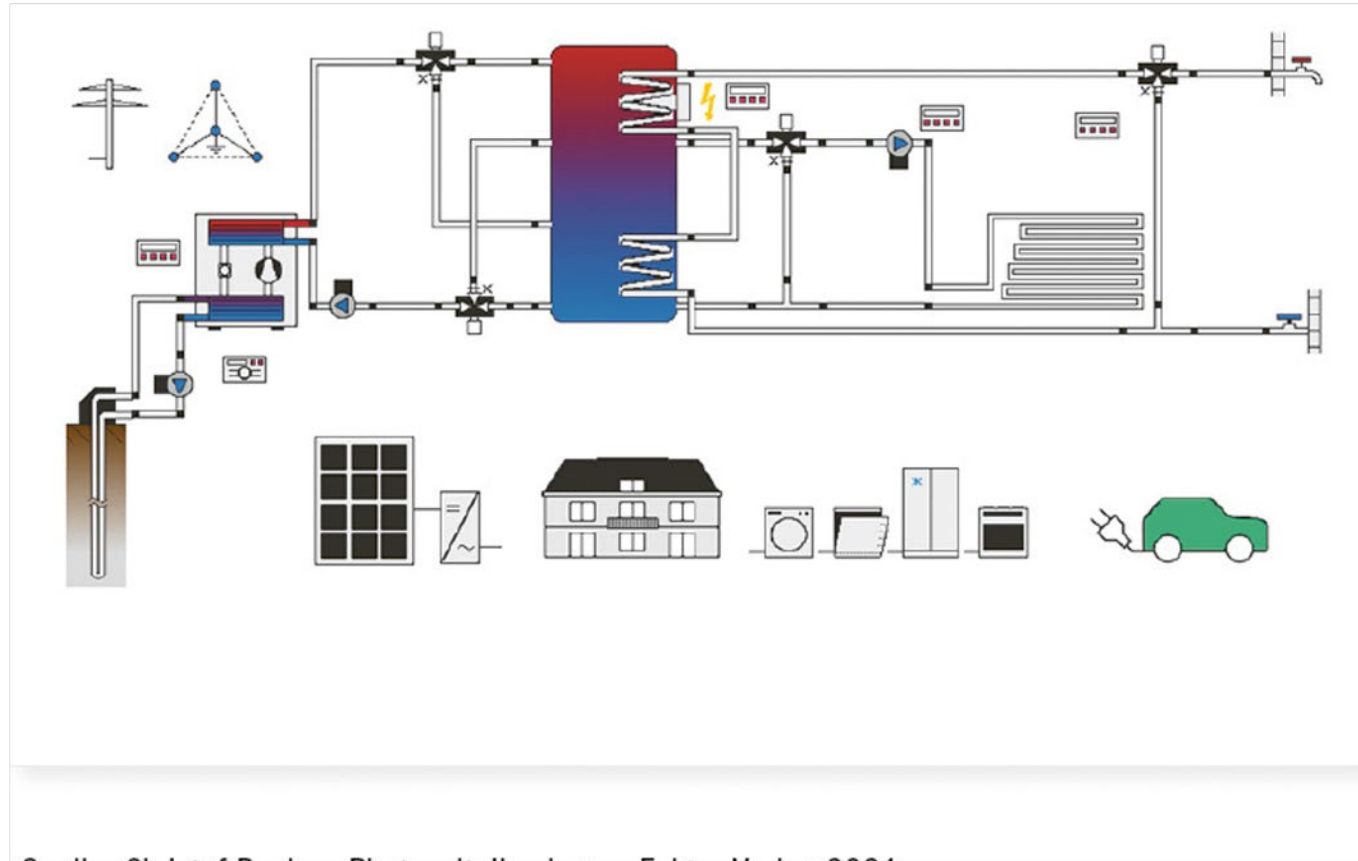

Quelle: Christof Bucher, Photovoltaikanlagen, Faktor Verlag 2021

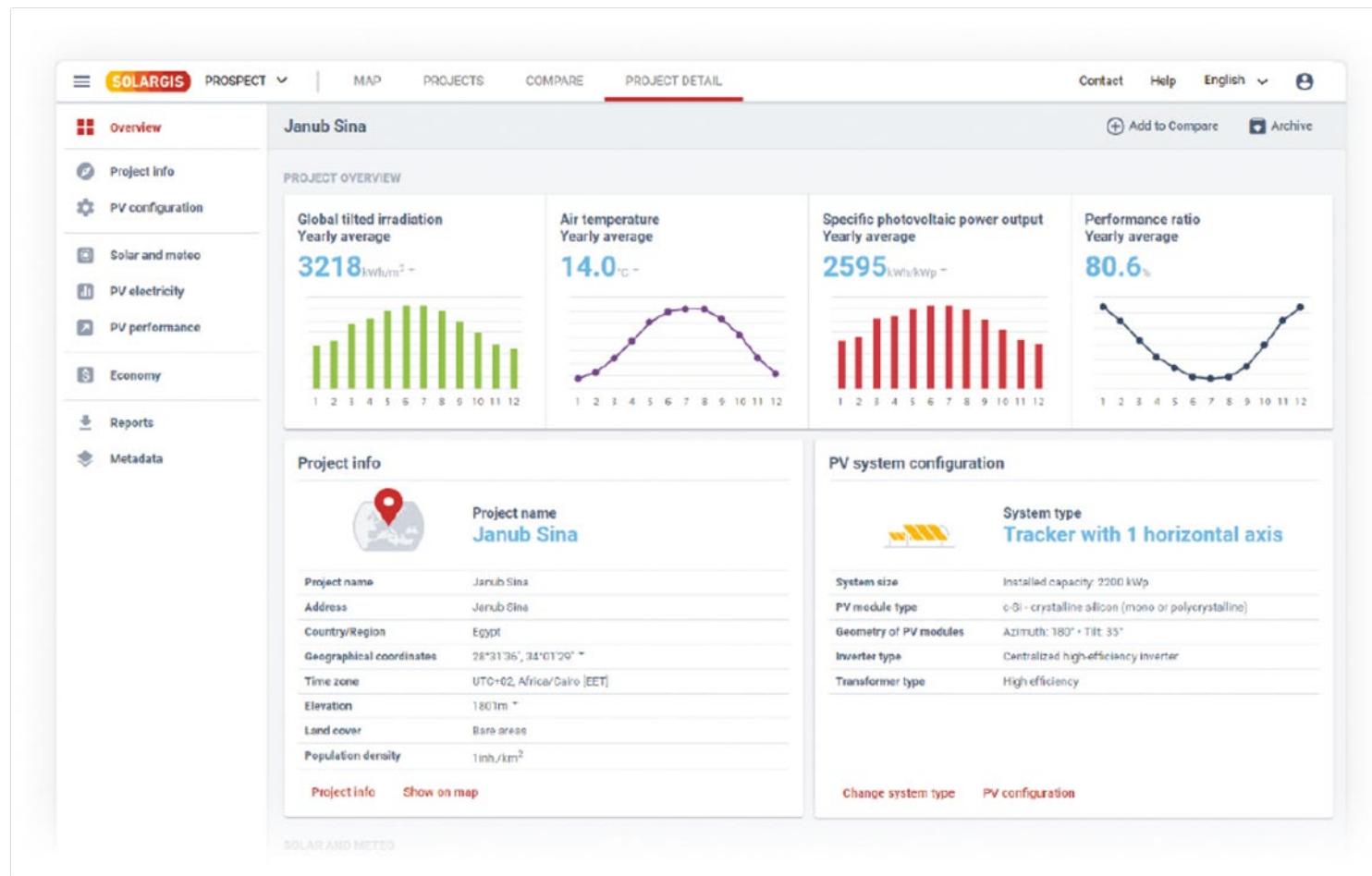

Quelle: Christof Bucher, Photovoltaikanlagen, Faktor Verlag 2021

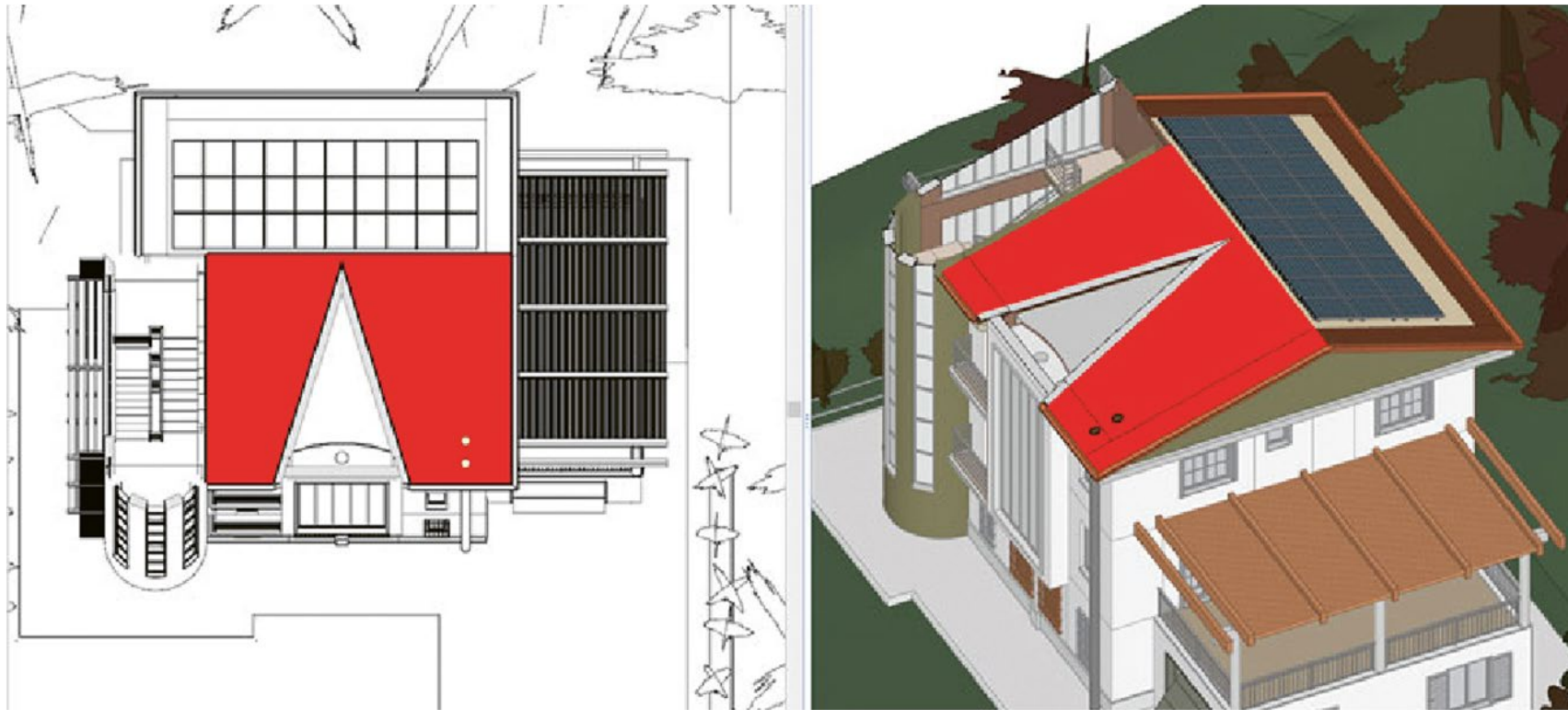

Quelle: Christof Bucher, Photovoltaikanlagen, Faktor Verlag 2021

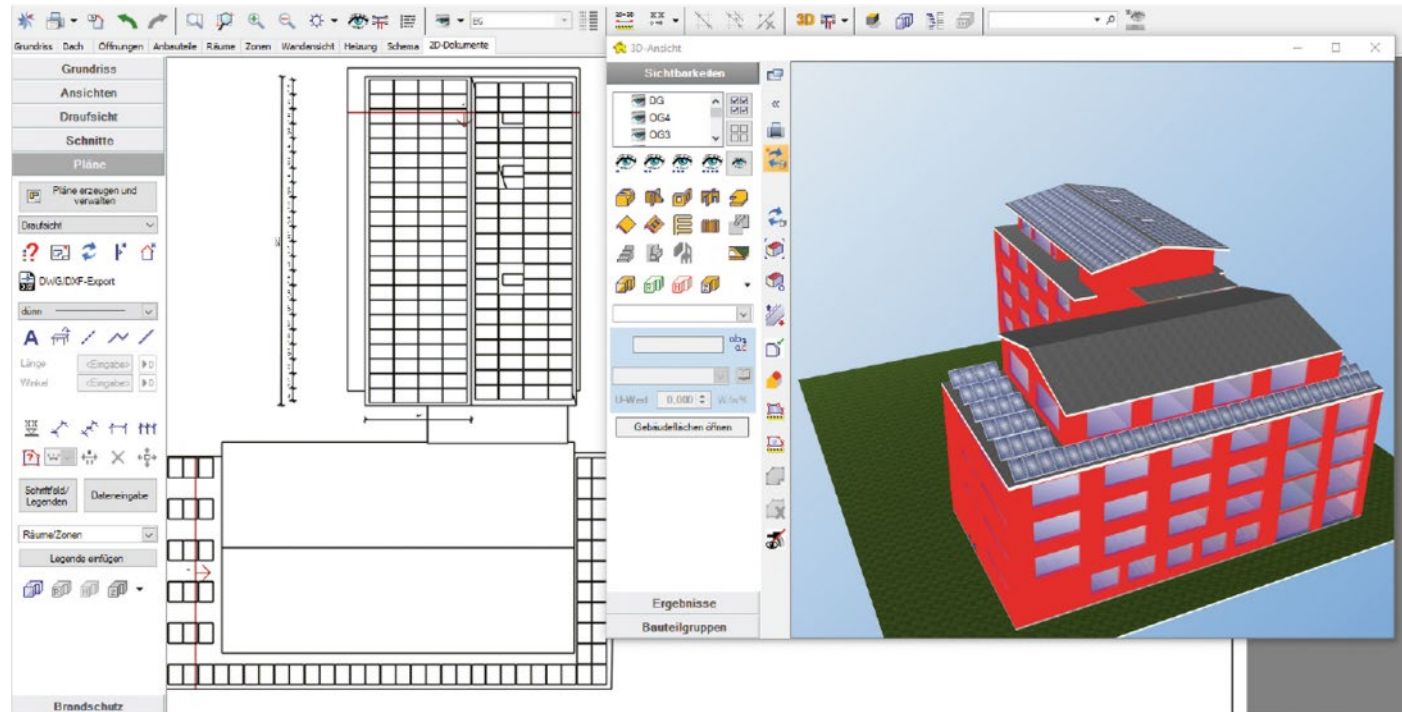

Quelle: Christof Bucher, Photovoltaikanlagen, Faktor Verlag 2021

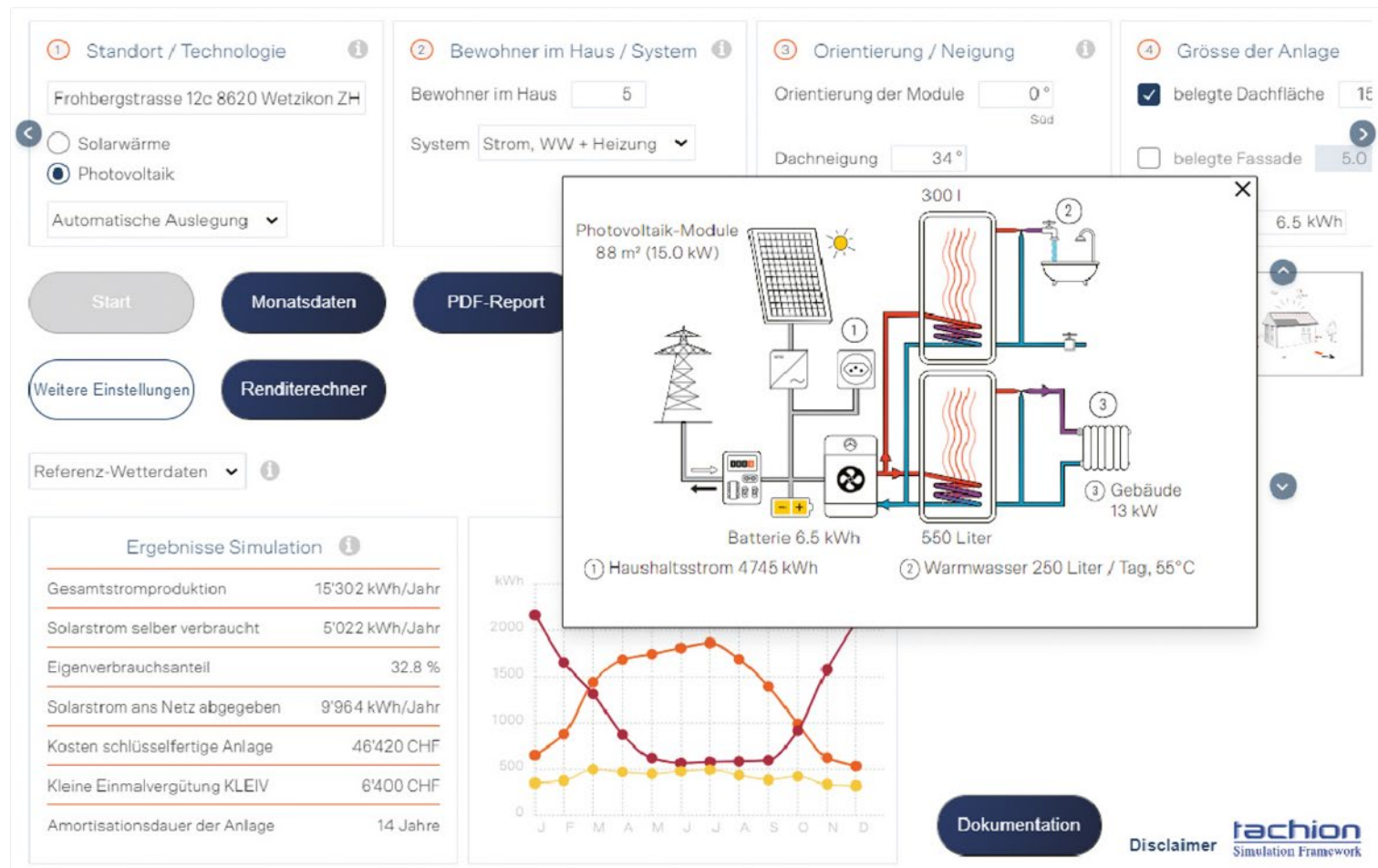

Quelle: Christof Bucher, Photovoltaikanlagen, Faktor Verlag 2021

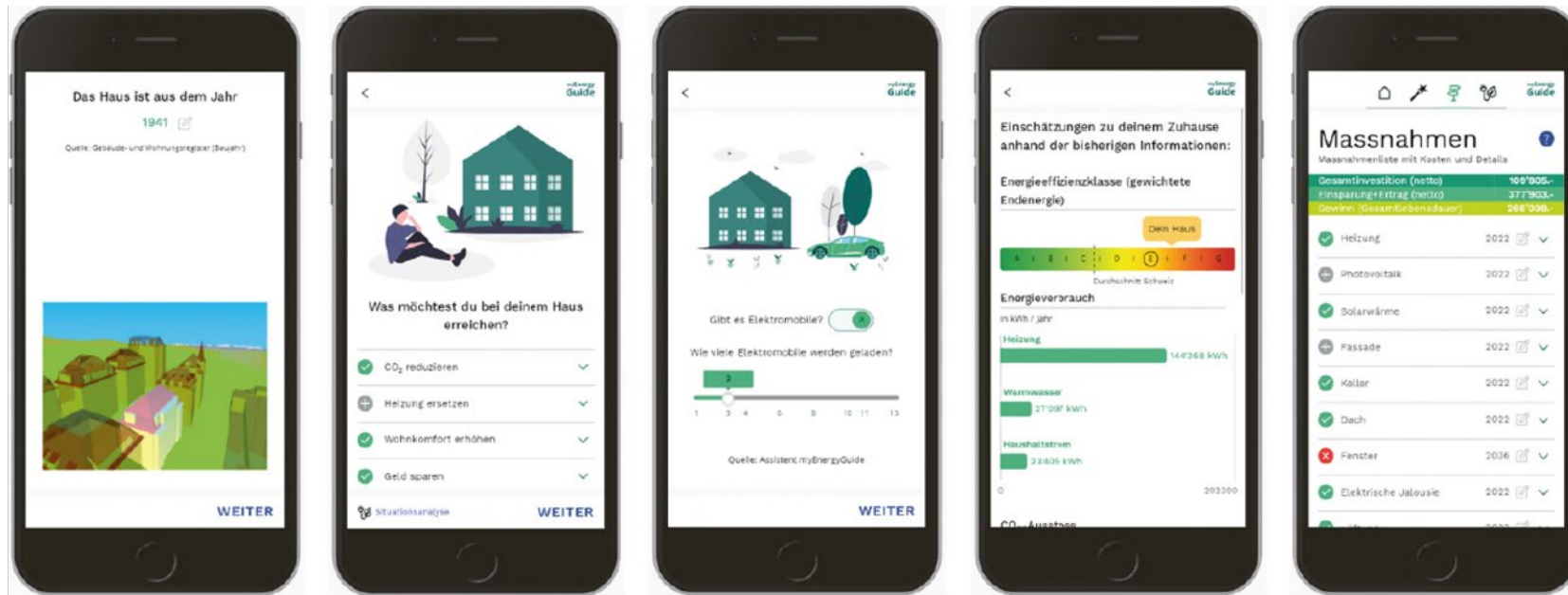

Quelle: Christof Bucher, Photovoltaikanlagen, Faktor Verlag 2021

Gebäudetechnik Rechner

https://stag.btc.suissetec.ch/de/form/1

WIR, DIE GEBÄUDETECHNIKER Deutsch

Gebäudetechnik Rechner

Reset 1 2 3 4 5 6 7 8 9

Auswahl PV PV & Solarthermie PV mit Wärmepumpe

Variantendefinition

- Warmwasser (WW)
- Gebäudetechnik/Heizung (GT)
- Sanierung der Gebäudehülle (GH)
- Photovoltaik (PV)
- Solarthermie (ST)
- Planer Modus aktivieren

Jahr	Jan	Feb	März	Apr.	Mai	Juni	Juli	Aug.	Sep.	Okt.	Nov.	Dez.
kWh	150	200	320	340	340	350	350	340	300	220	140	110

Schweizerisch-Liechtensteiner Gebäudetechnikverband (suissetec) suissetec

Quelle: Christof Bucher, Photovoltaikanlagen, Faktor Verlag 2021

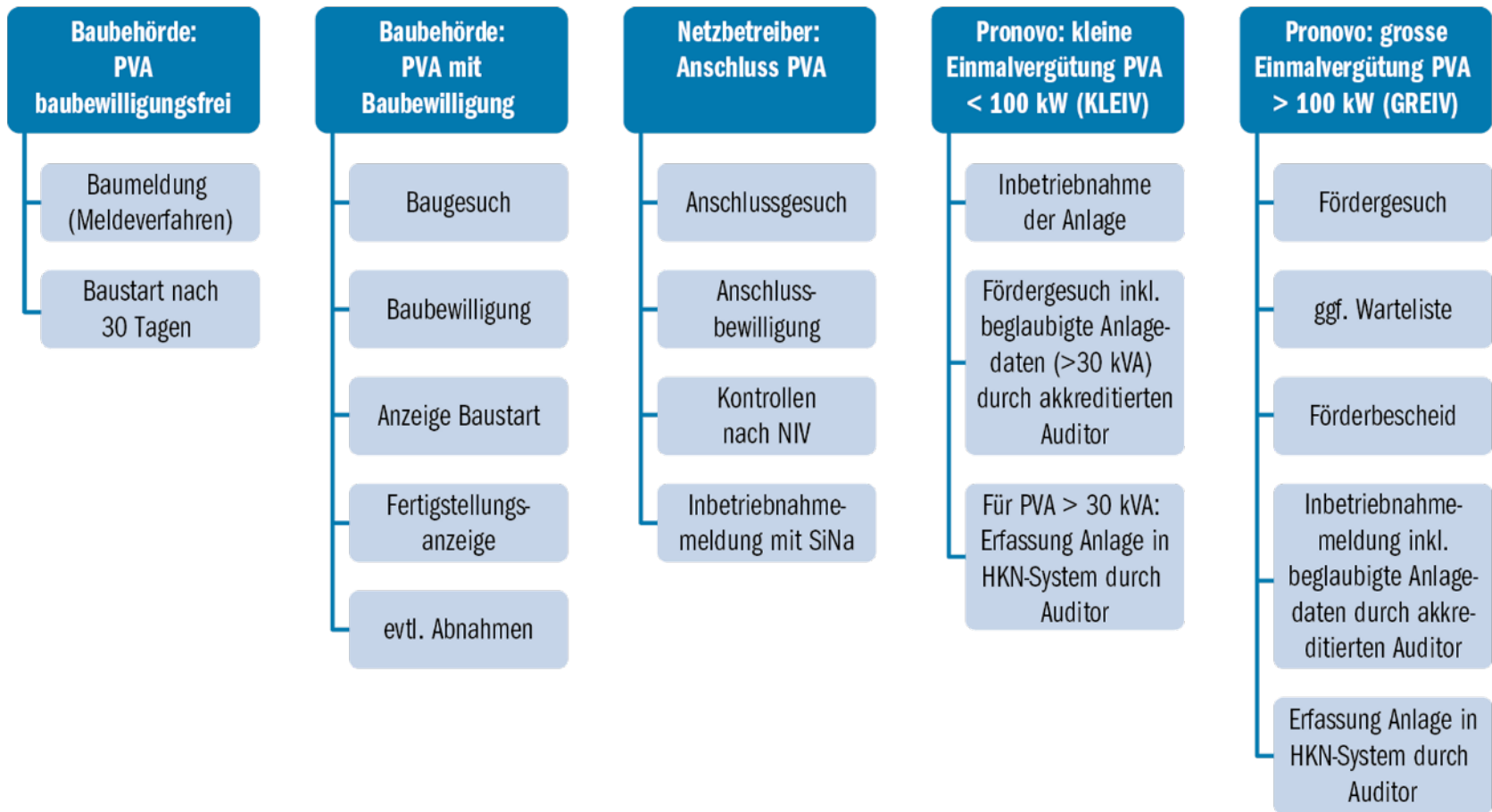

Quelle: Christof Bucher, Photovoltaikanlagen, Faktor Verlag 2021

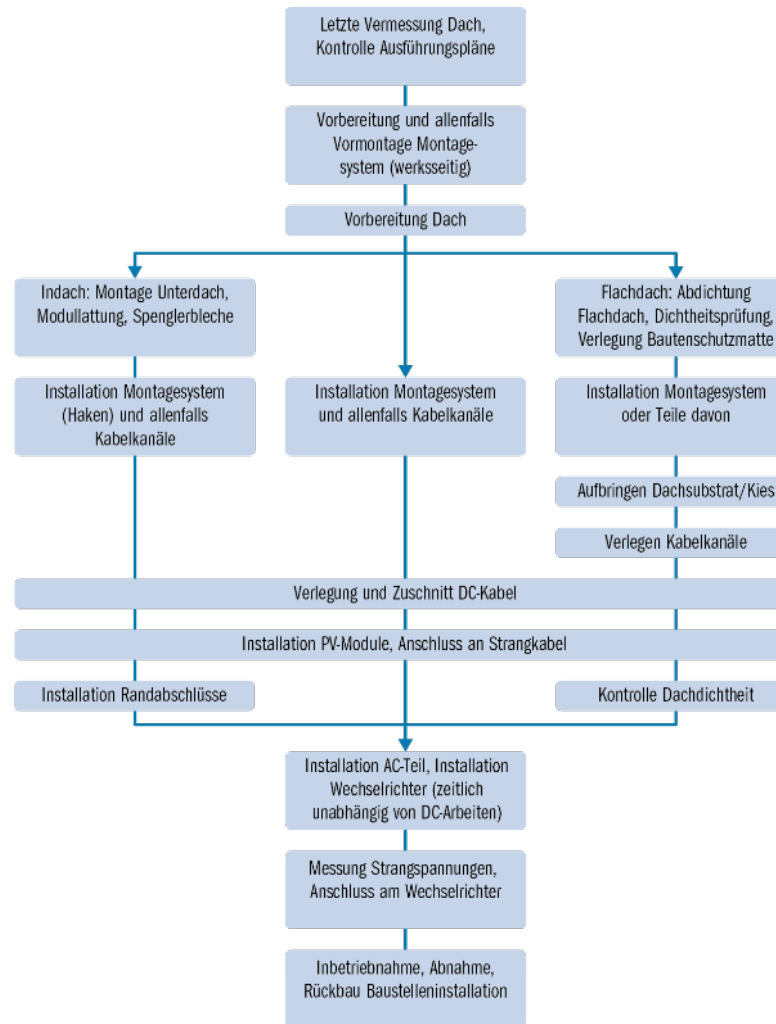

Quelle: Christof Bucher, Photovoltaikanlagen, Faktor Verlag 2021

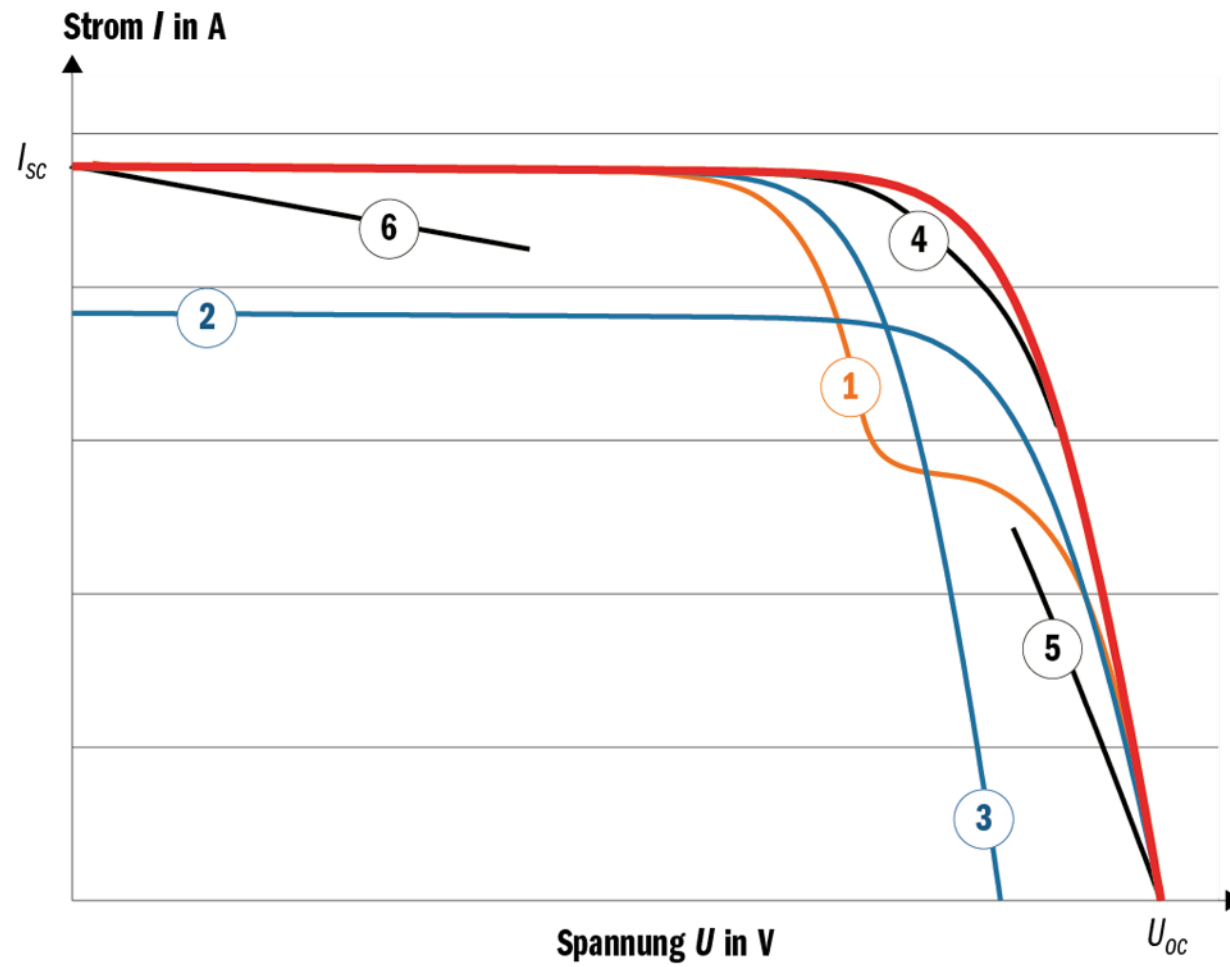

Quelle: Christof Bucher, Photovoltaikanlagen, Faktor Verlag 2021

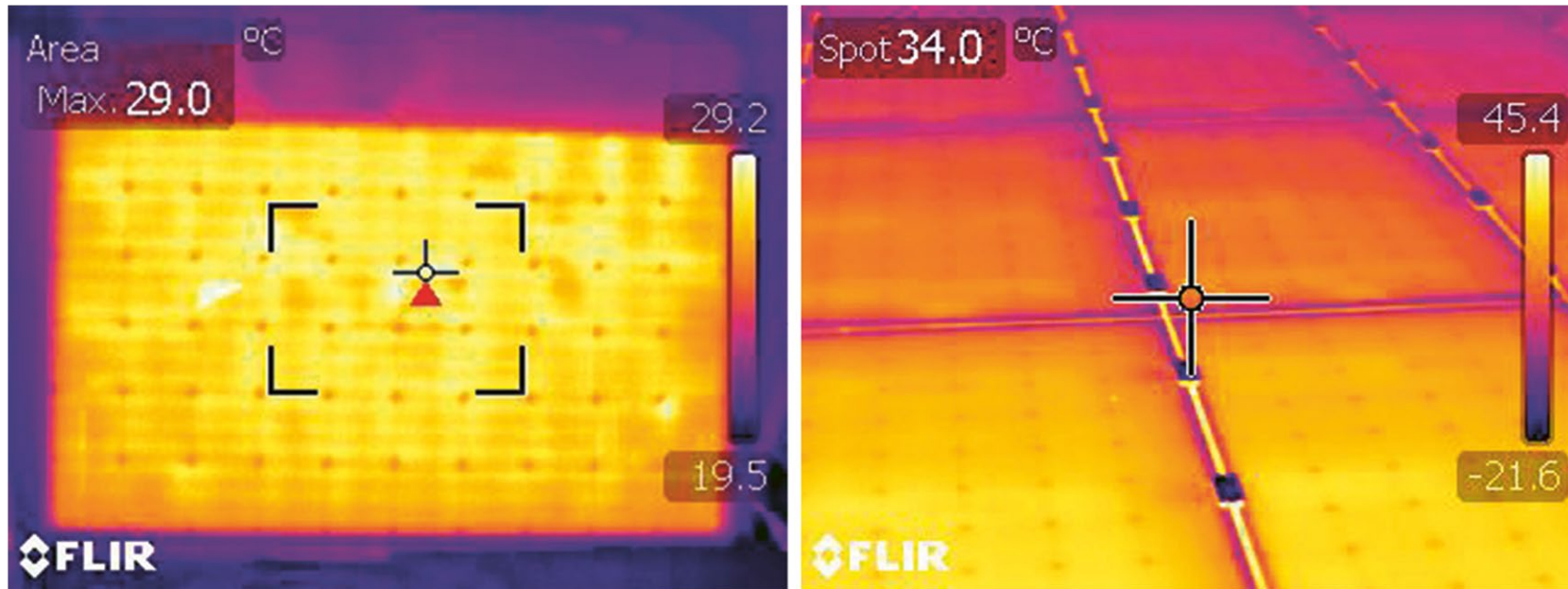

Quelle: Christof Bucher, Photovoltaikanlagen, Faktor Verlag 2021

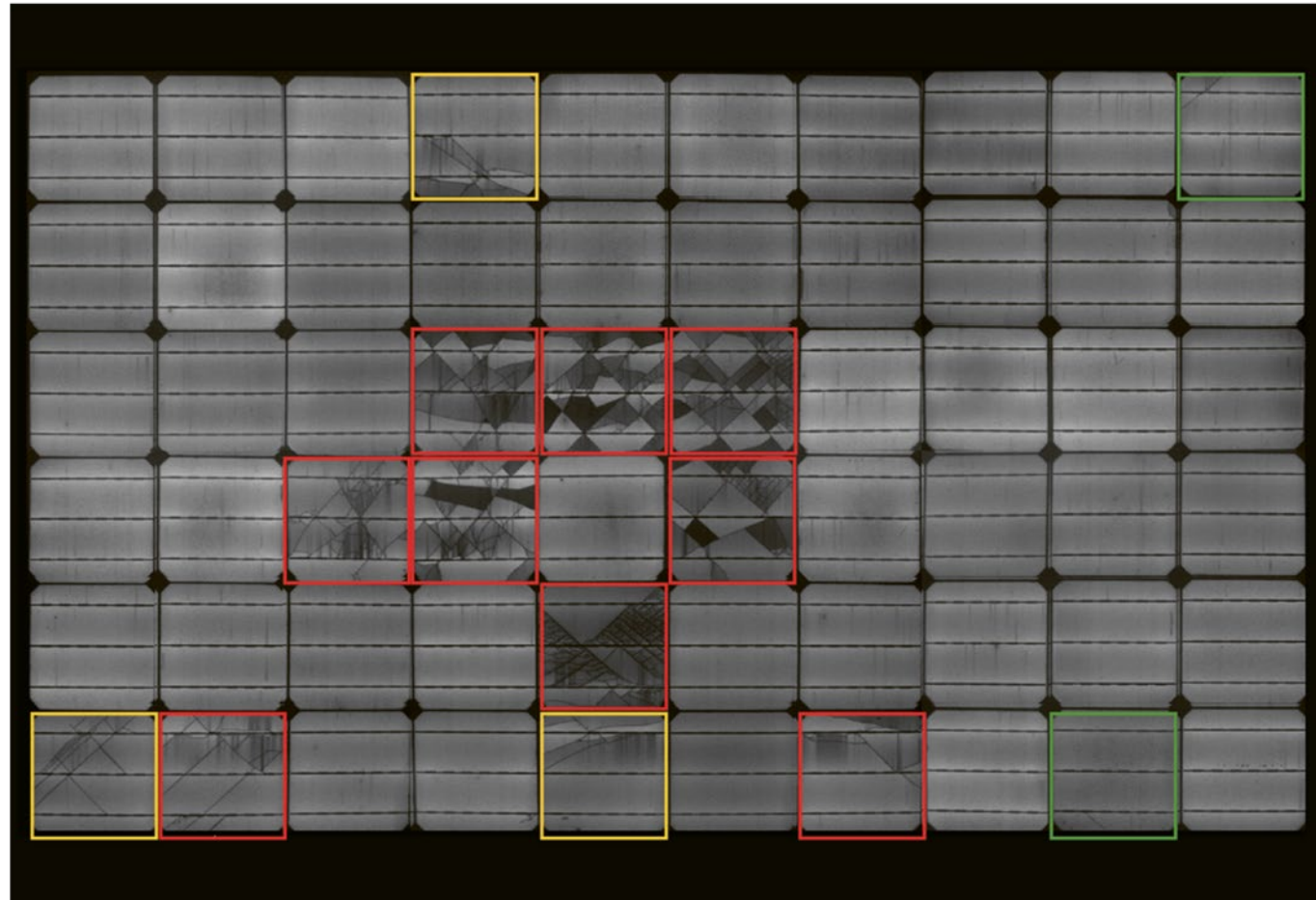

Quelle: Christof Bucher, Photovoltaikanlagen, Faktor Verlag 2021

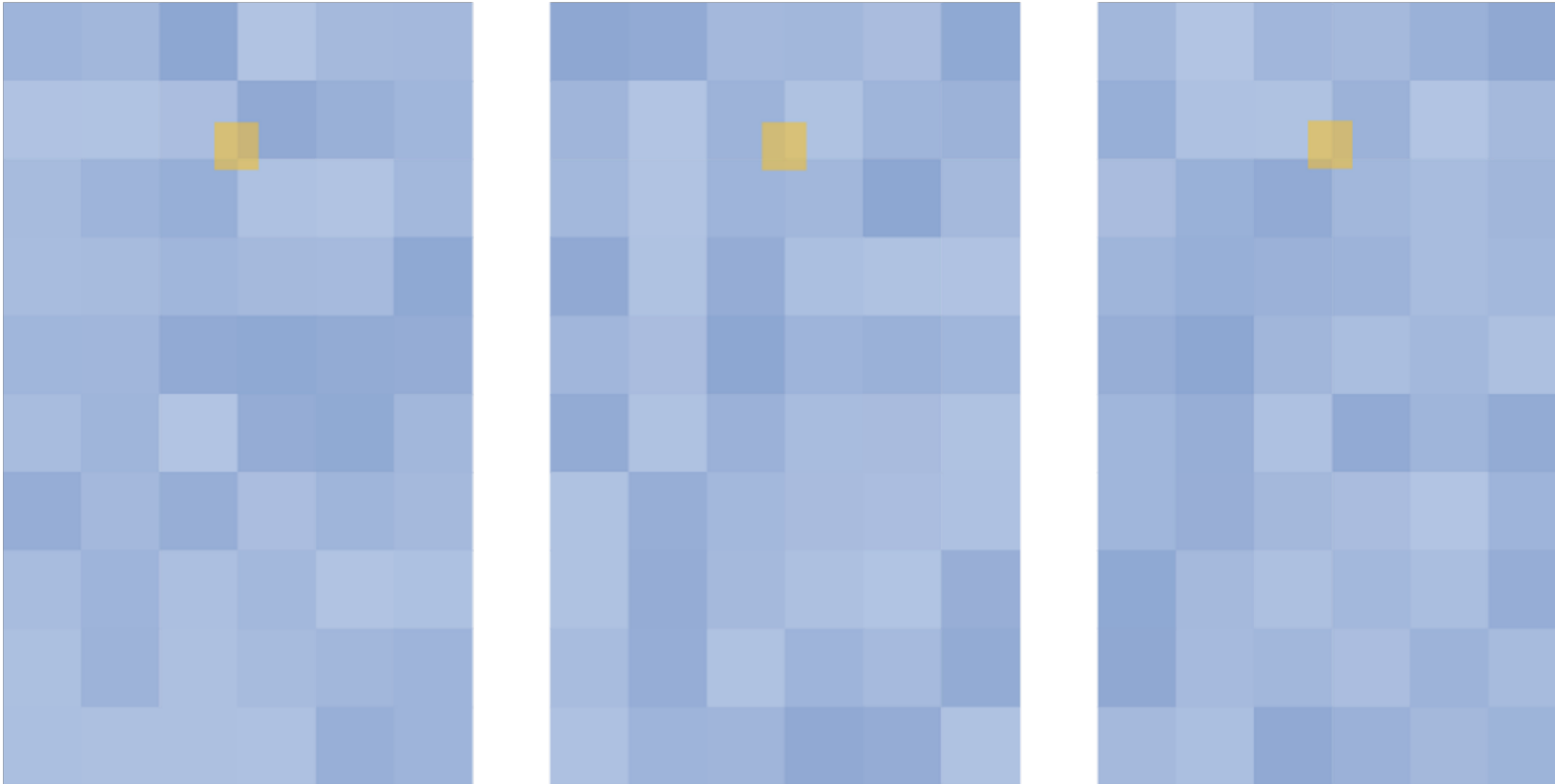

Quelle: Christof Bucher, Photovoltaikanlagen, Faktor Verlag 2021

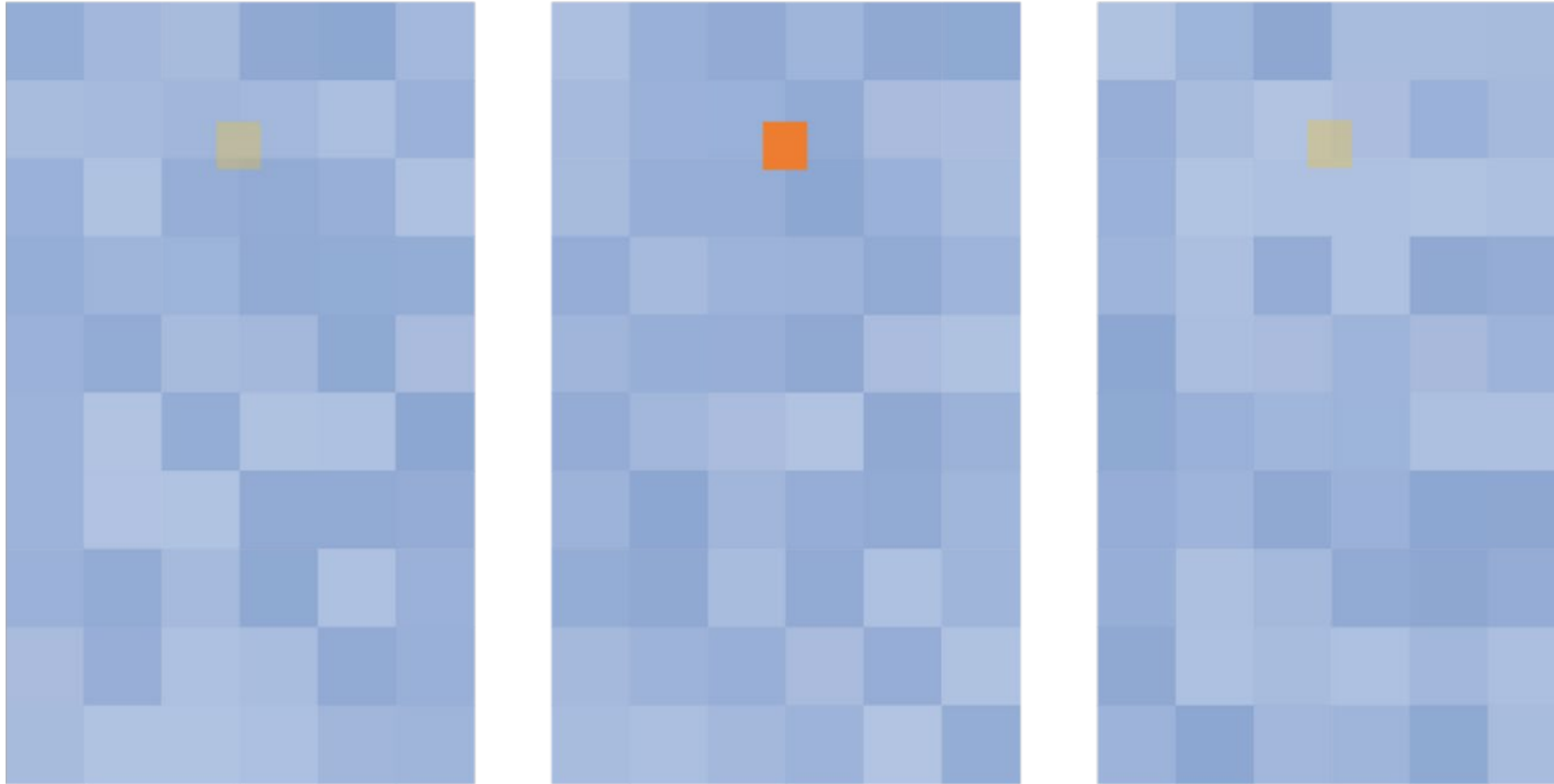

Quelle: Christof Bucher, Photovoltaikanlagen, Faktor Verlag 2021

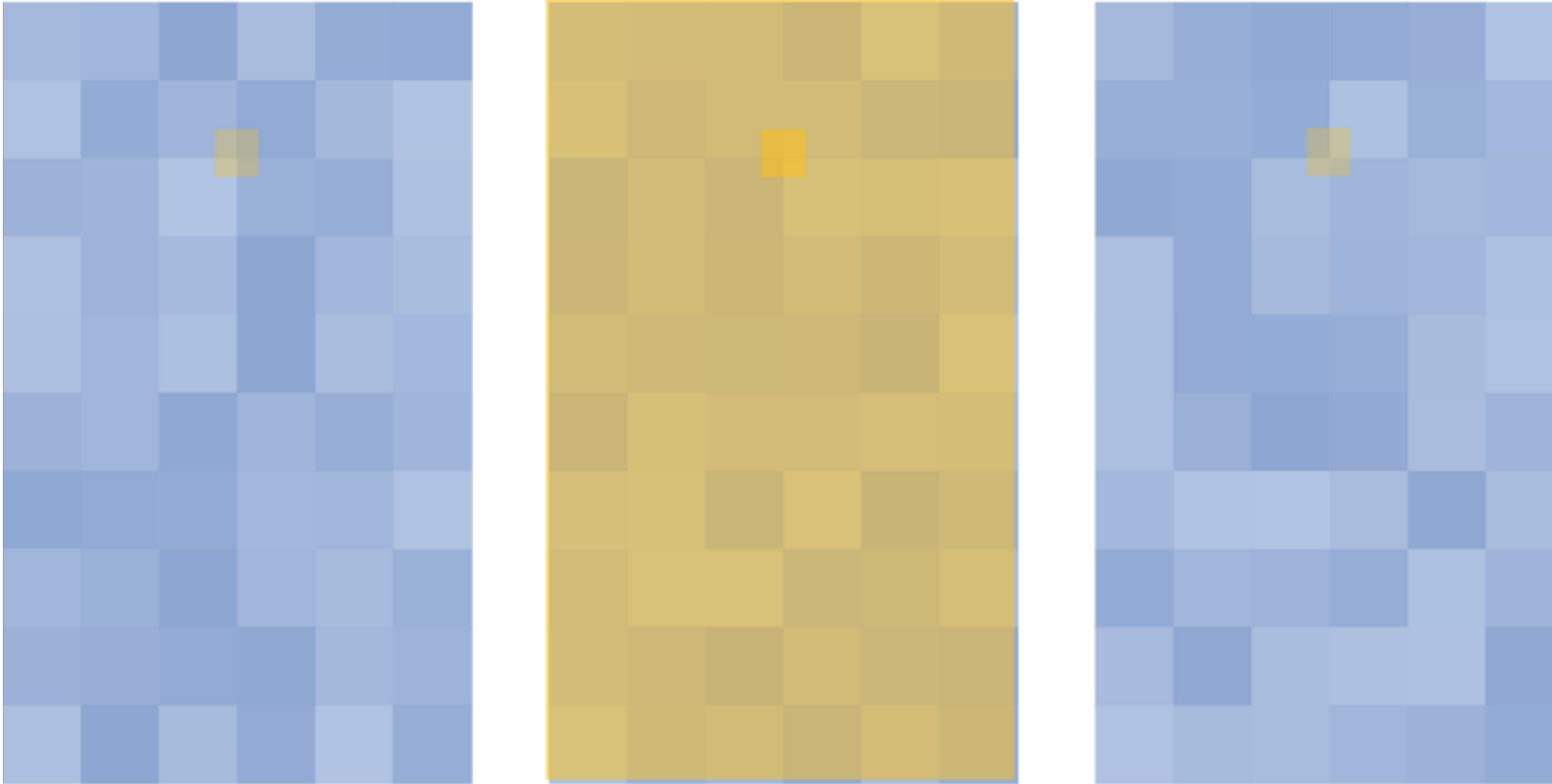

Quelle: Christof Bucher, Photovoltaikanlagen, Faktor Verlag 2021

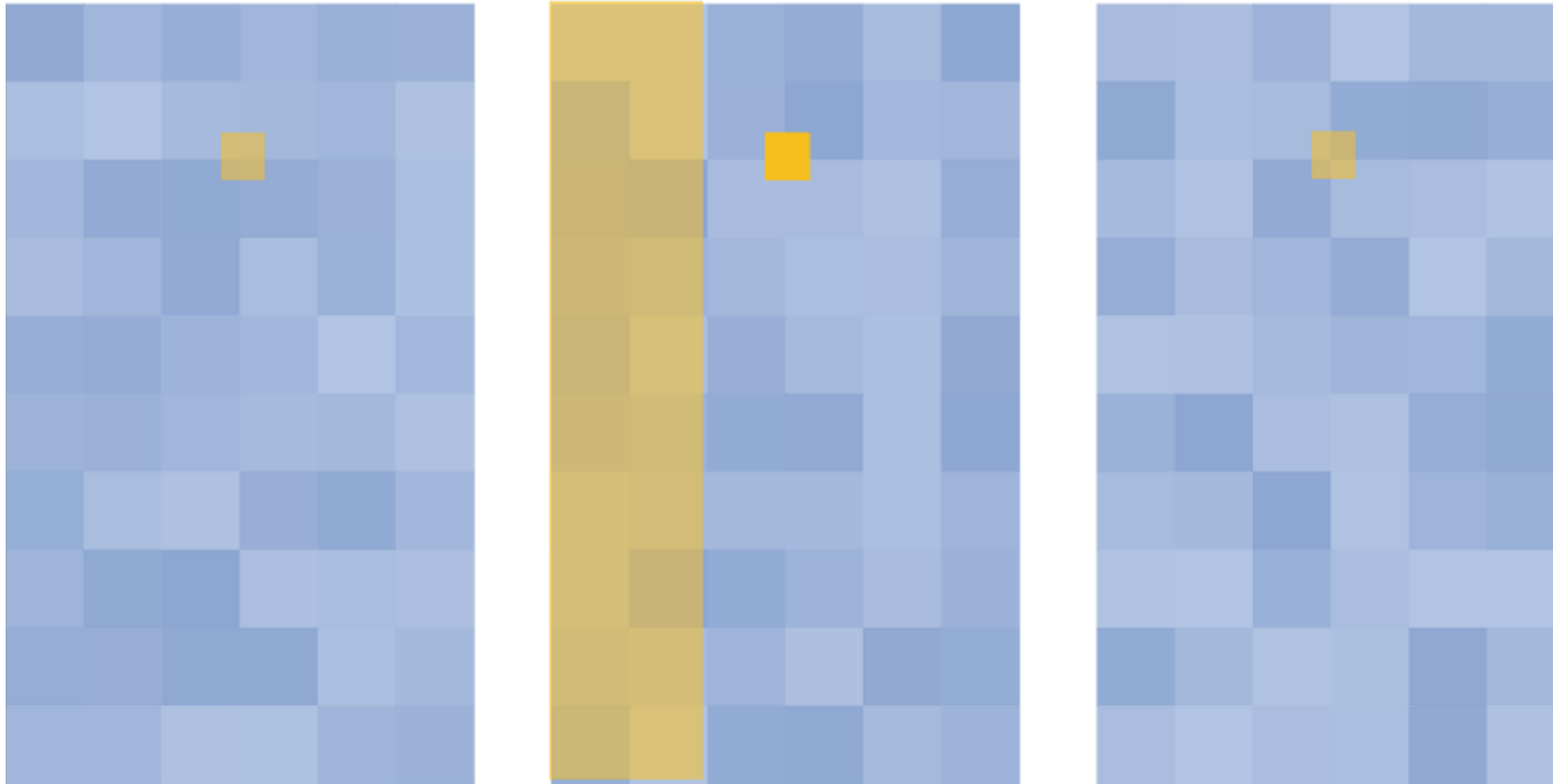

Quelle: Christof Bucher, Photovoltaikanlagen, Faktor Verlag 2021

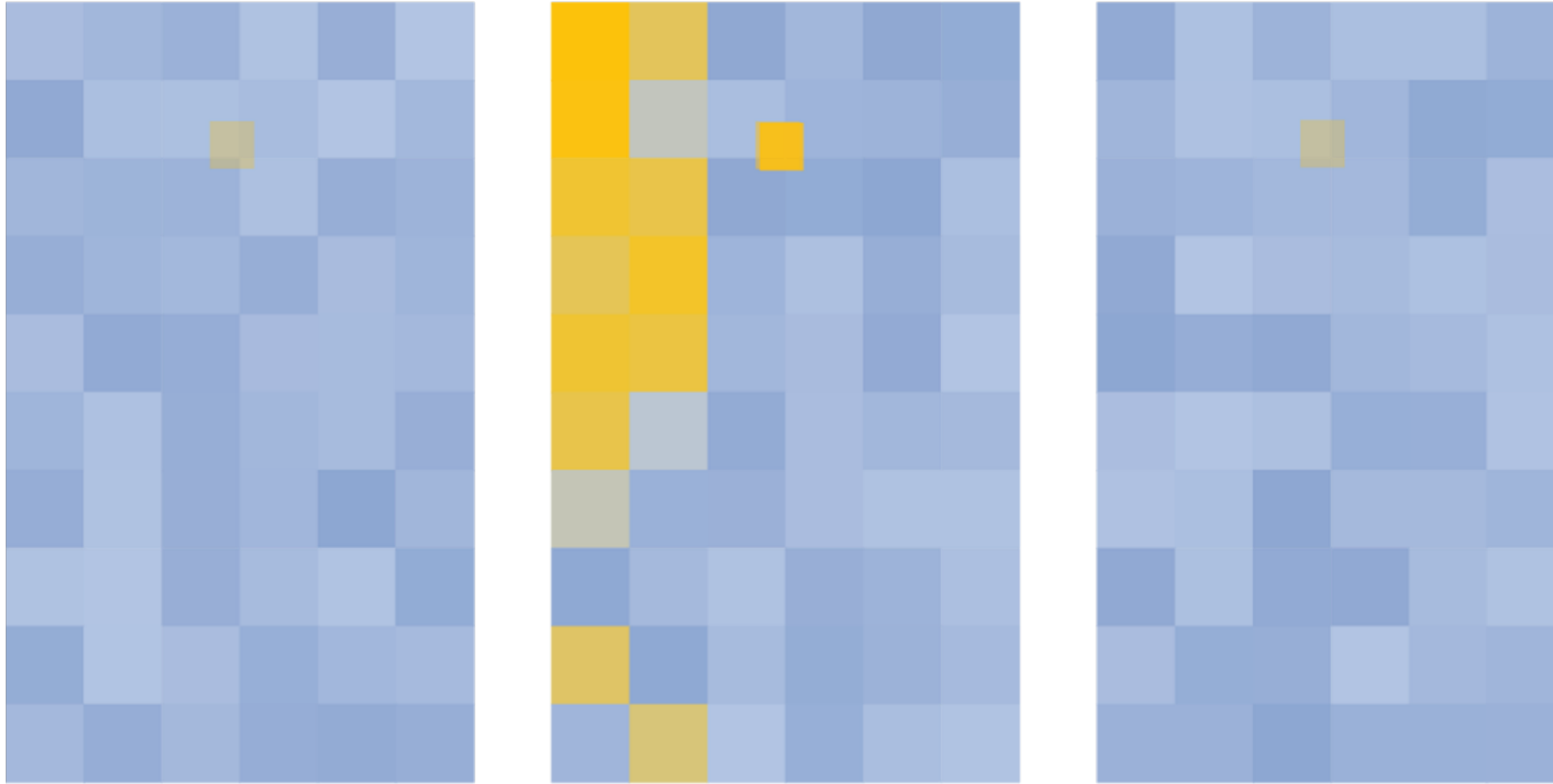

Quelle: Christof Bucher, Photovoltaikanlagen, Faktor Verlag 2021

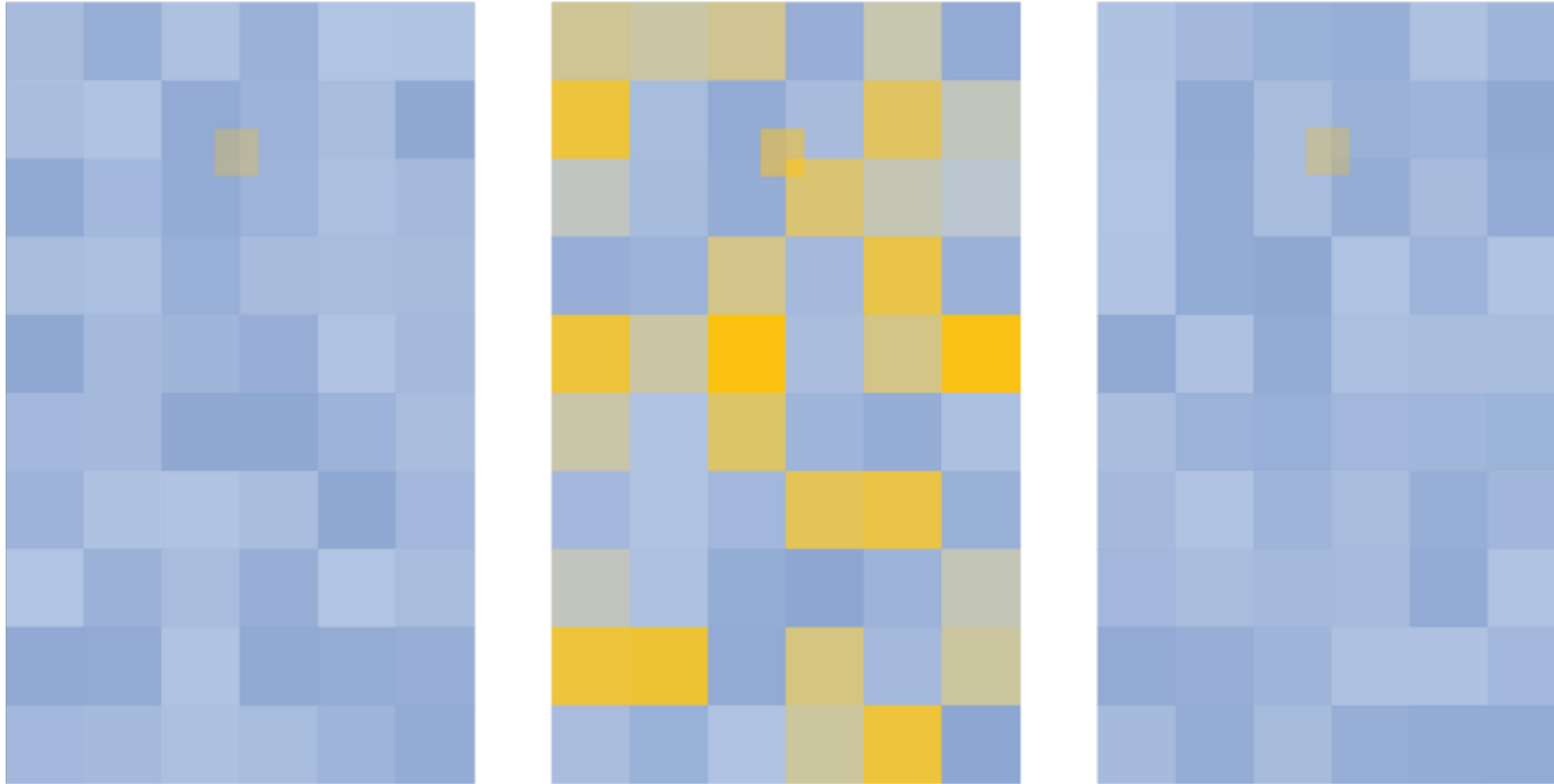

Quelle: Christof Bucher, Photovoltaikanlagen, Faktor Verlag 2021

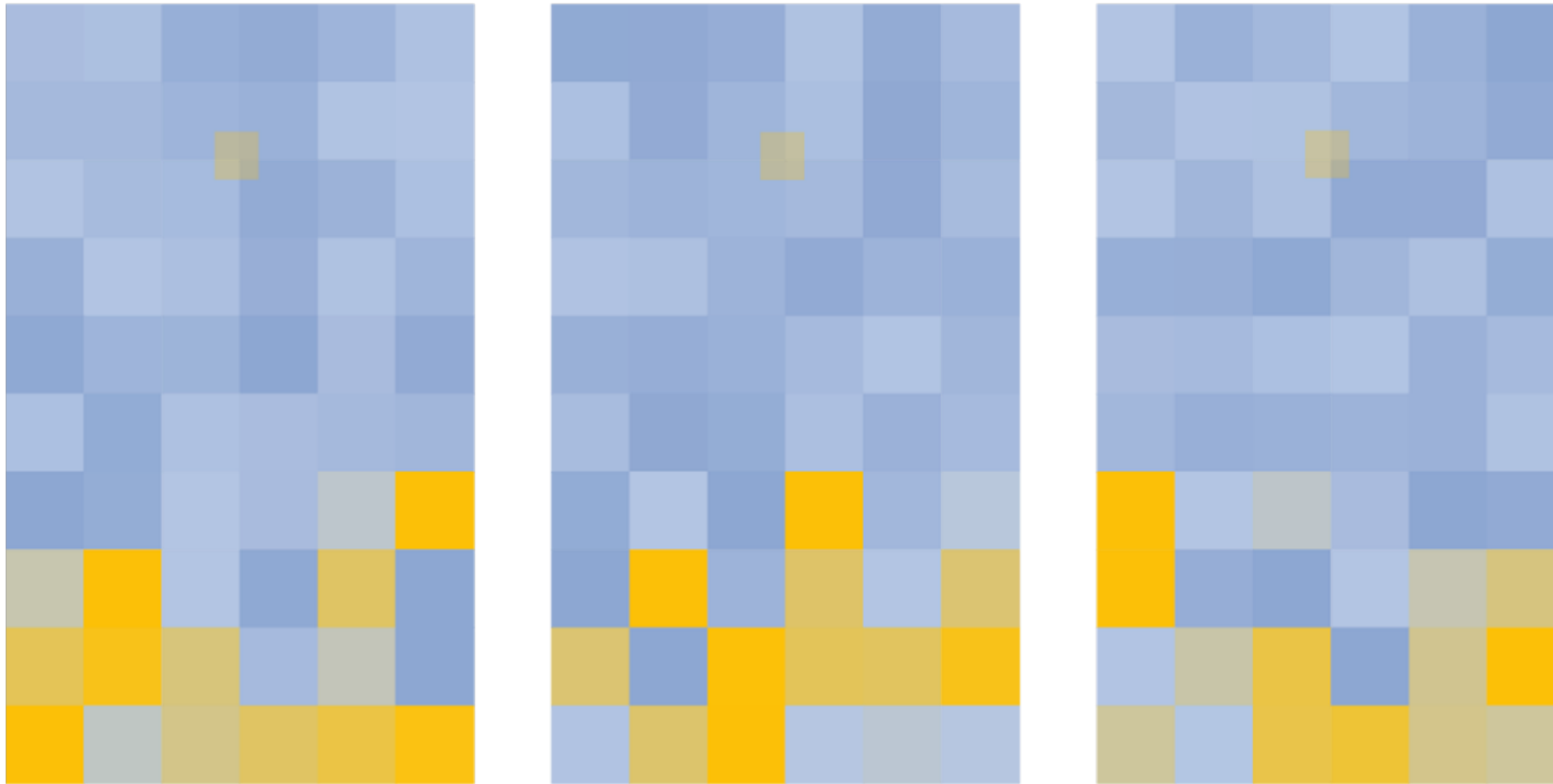

Quelle: Christof Bucher, Photovoltaikanlagen, Faktor Verlag 2021

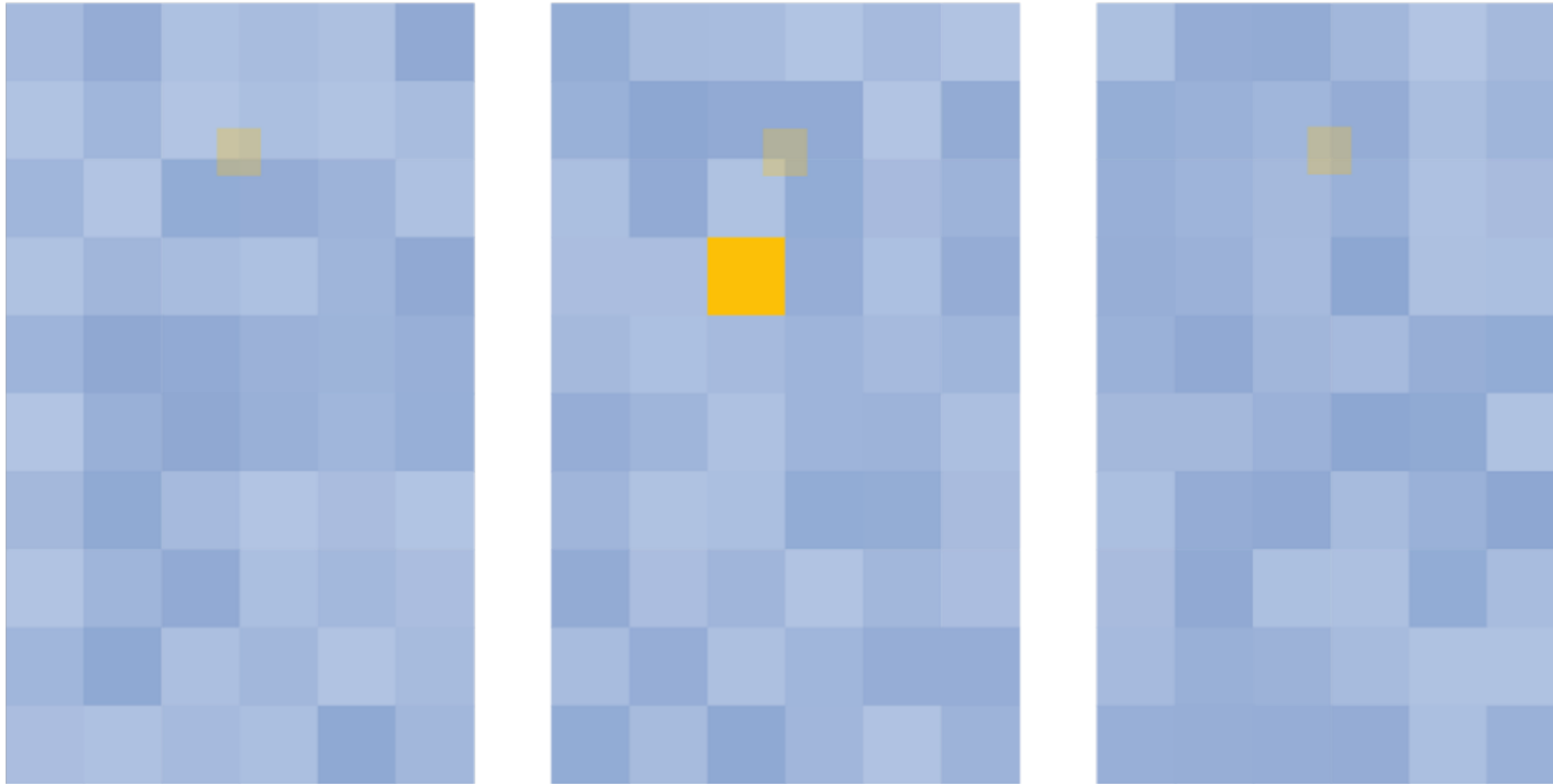

Quelle: Christof Bucher, Photovoltaikanlagen, Faktor Verlag 2021

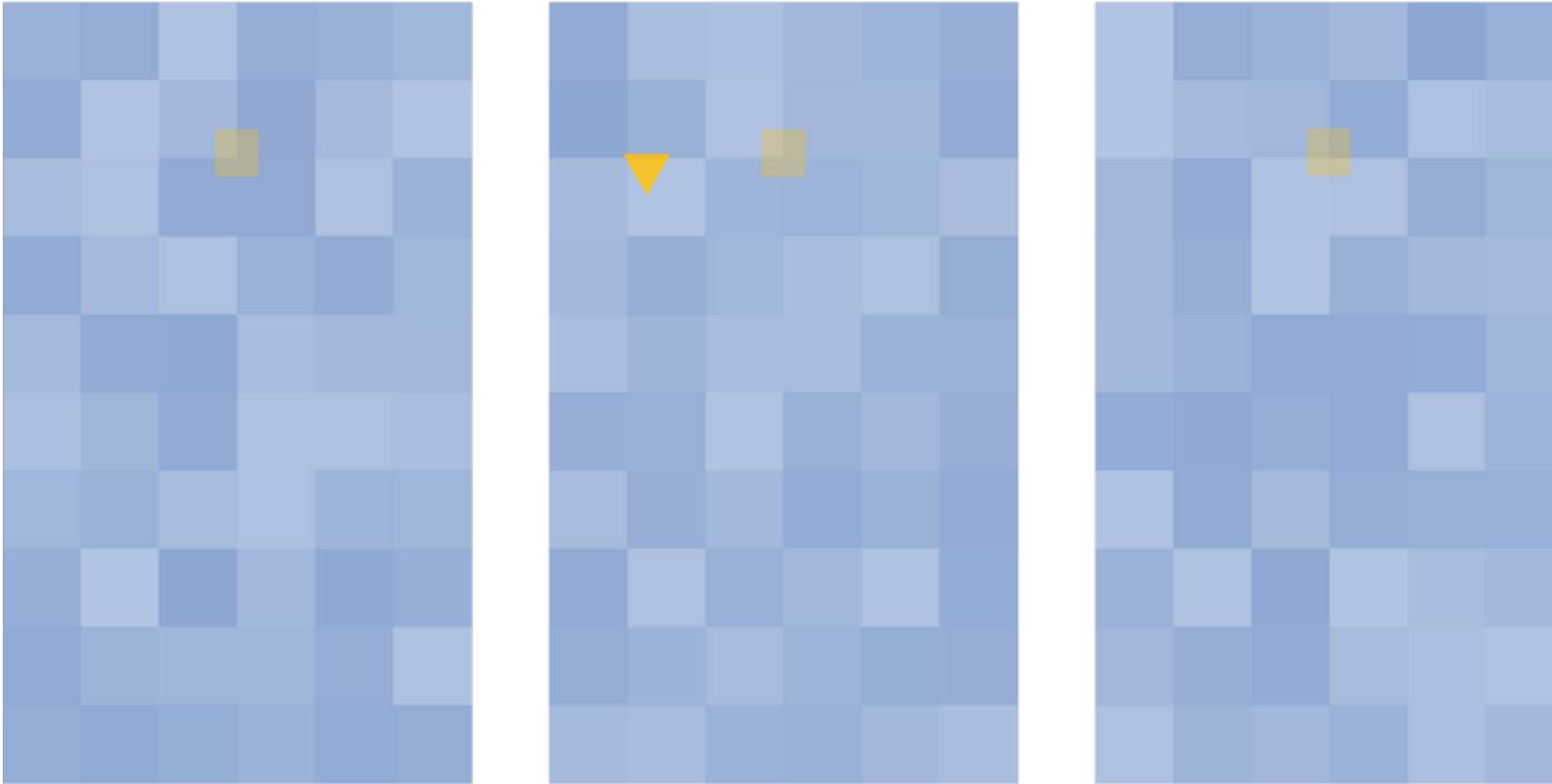

Quelle: Christof Bucher, Photovoltaikanlagen, Faktor Verlag 2021

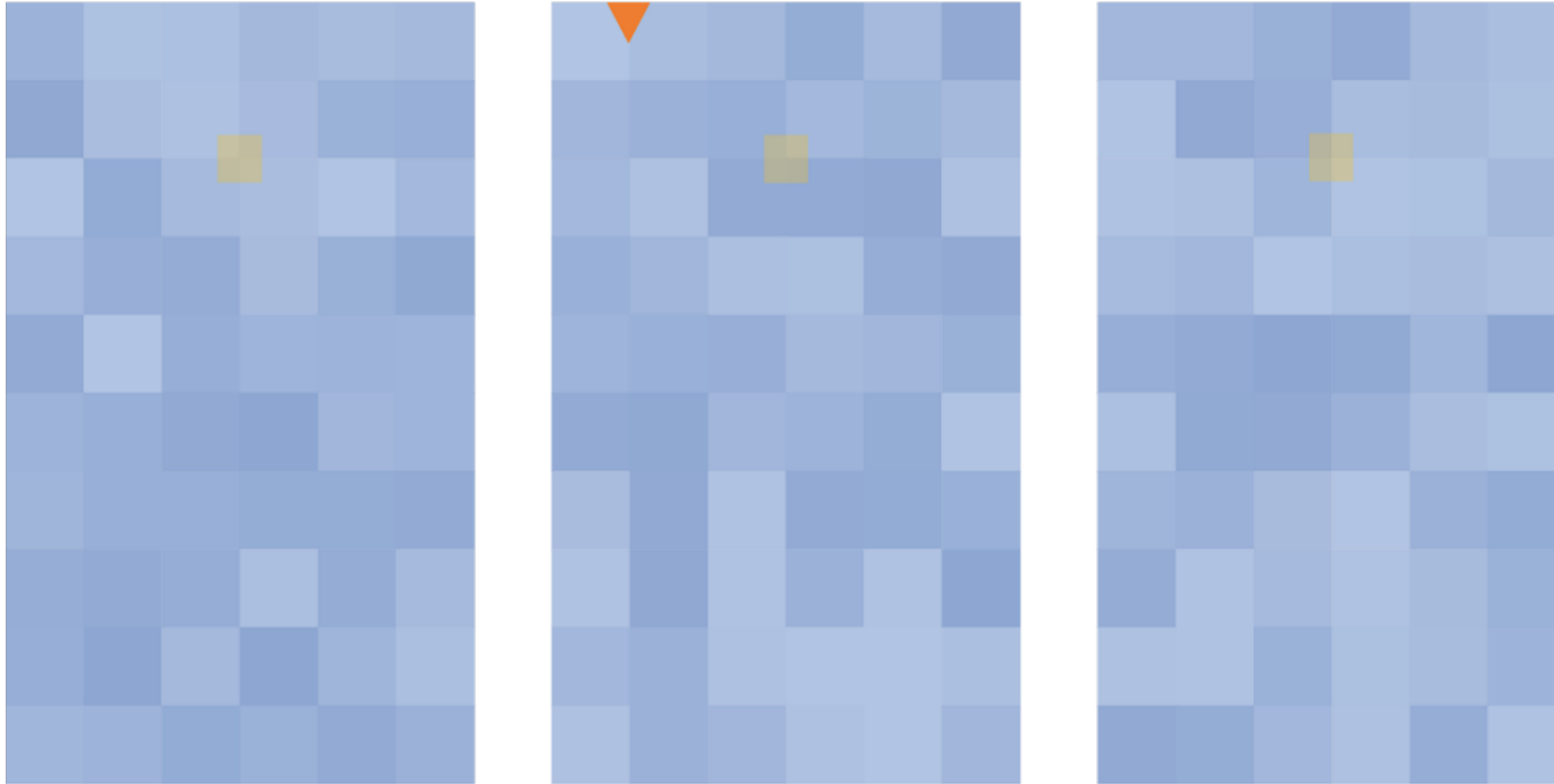

Quelle: Christof Bucher, Photovoltaikanlagen, Faktor Verlag 2021

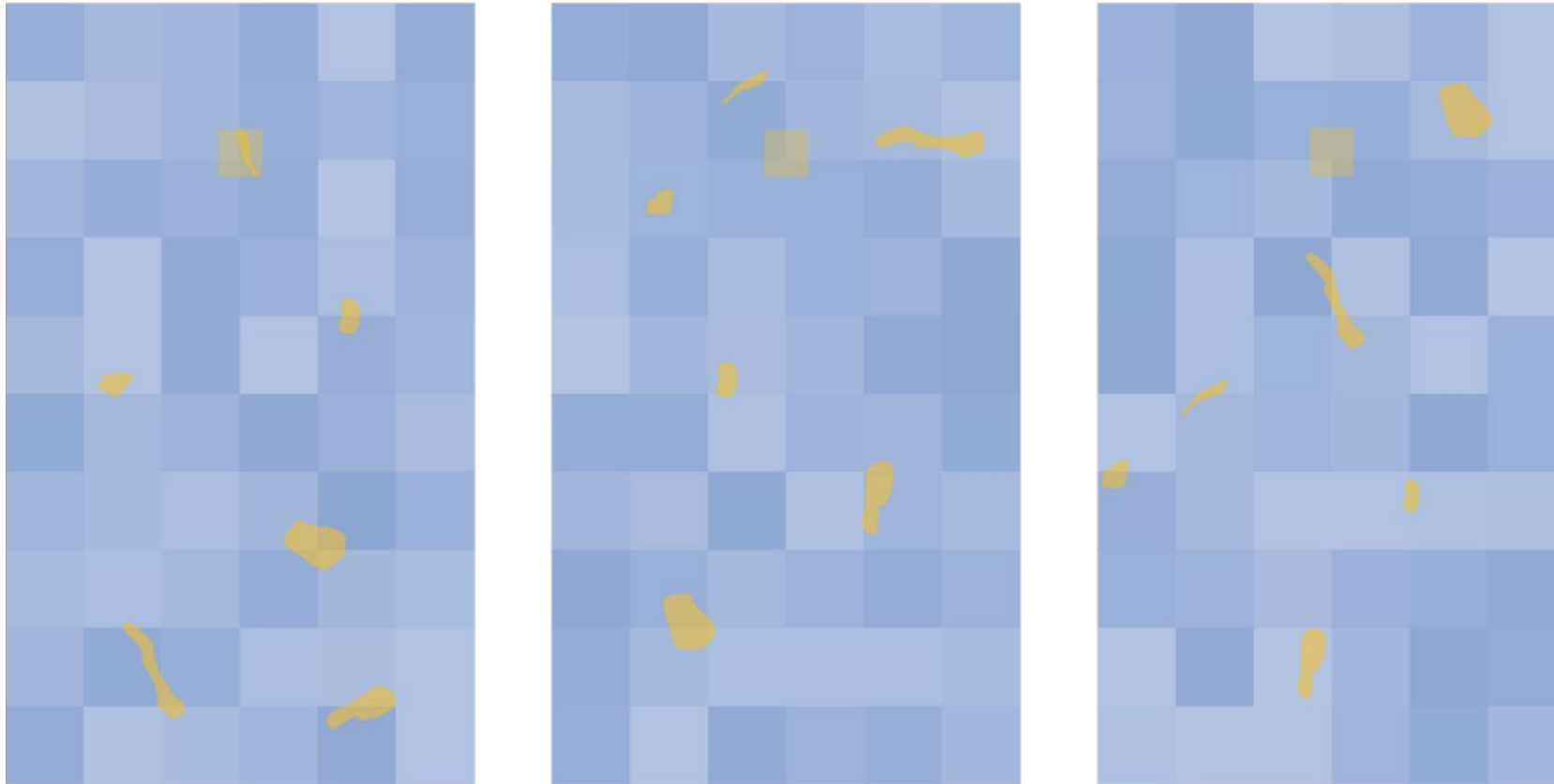

Quelle: Christof Bucher, Photovoltaikanlagen, Faktor Verlag 2021

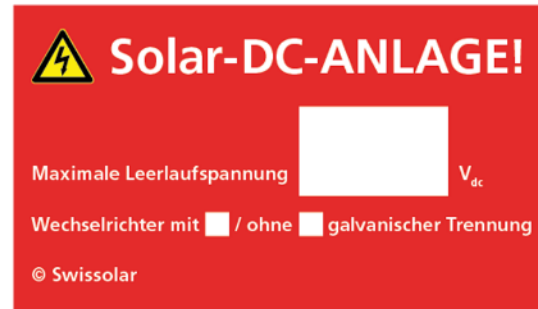
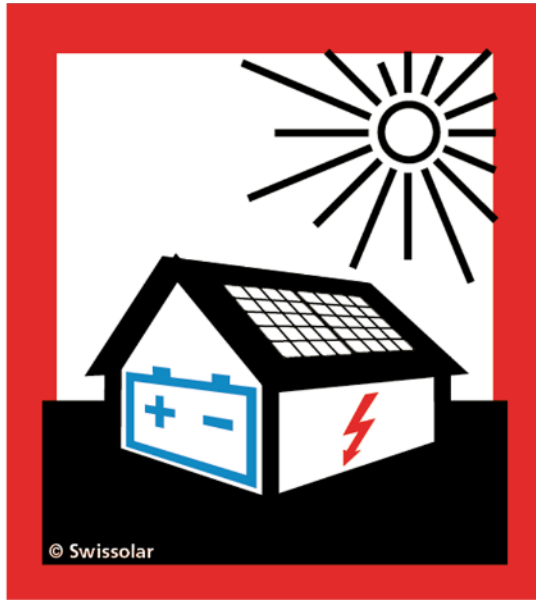
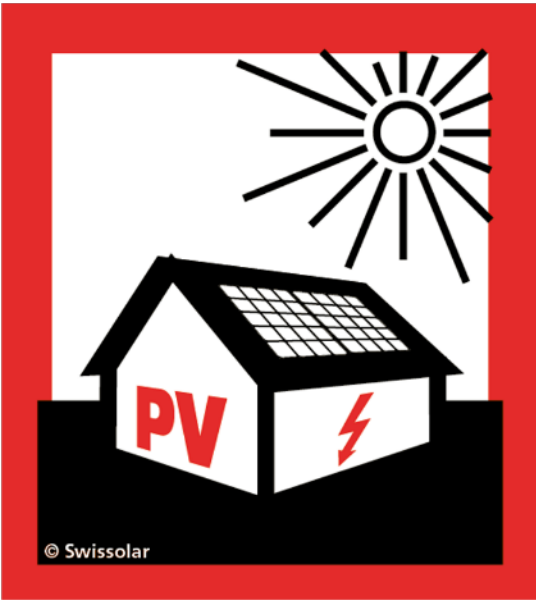

Quelle: Christof Bucher, Photovoltaikanlagen, Faktor Verlag 2021

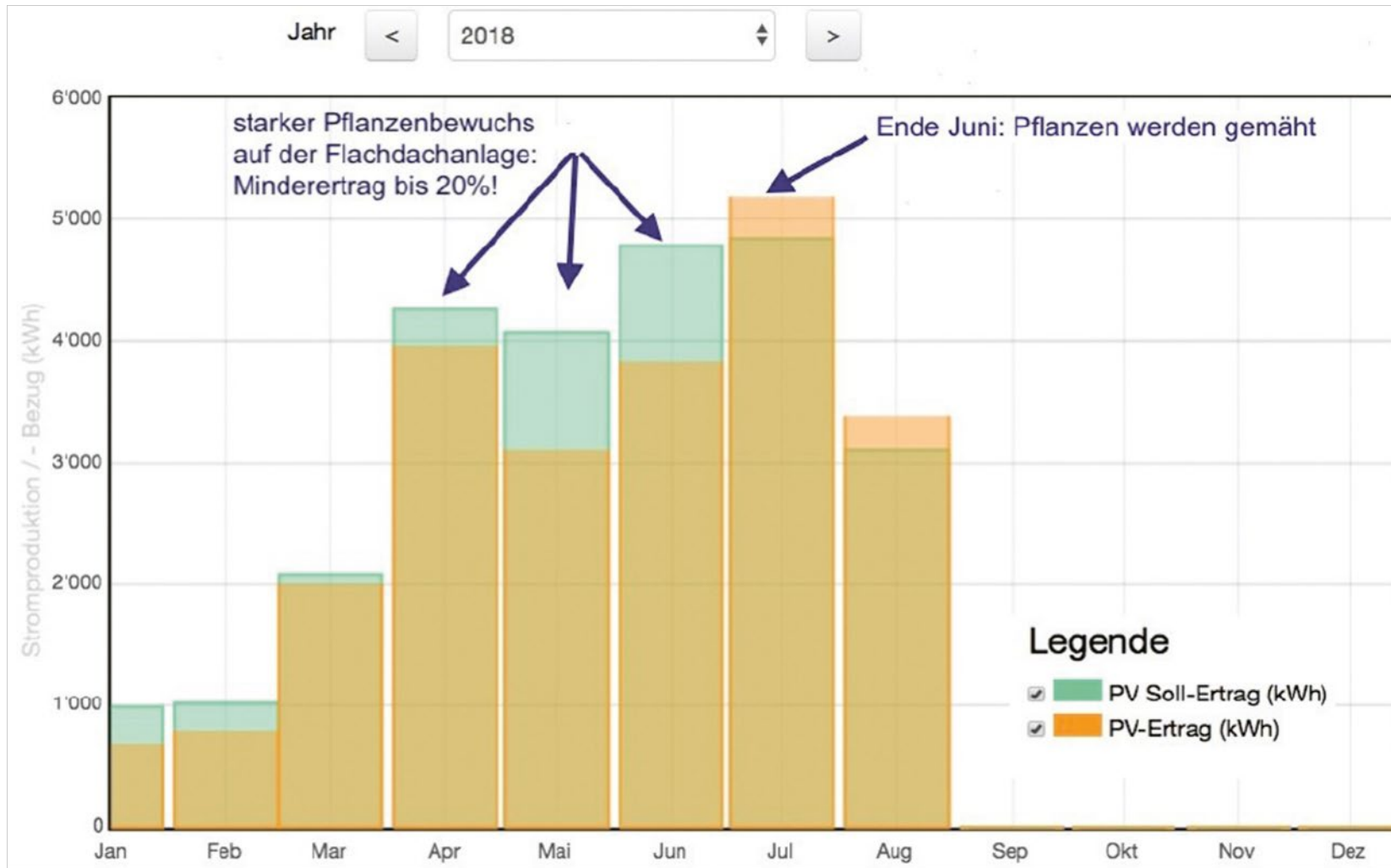

Quelle: Christof Bucher, Photovoltaikanlagen, Faktor Verlag 2021



Quelle: Christof Bucher, Photovoltaikanlagen, Faktor Verlag 2021

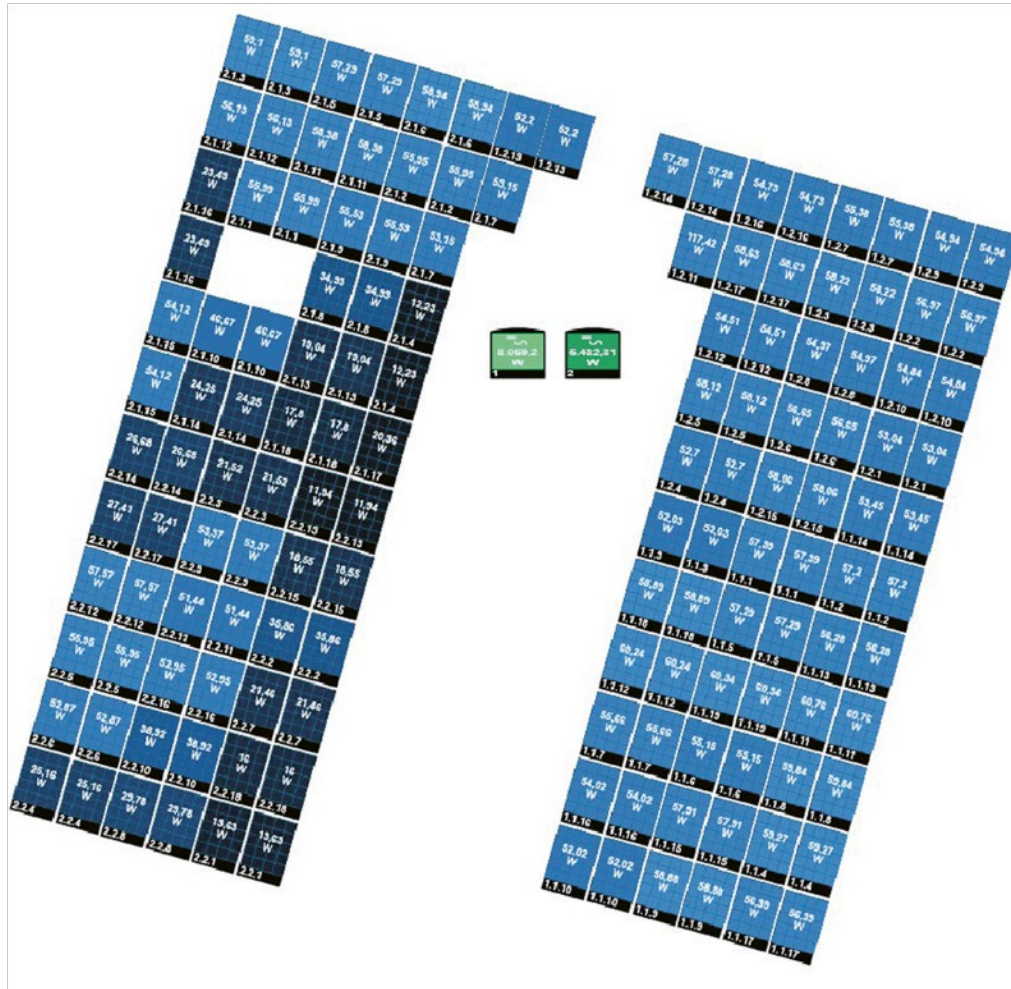

Quelle: Christof Bucher, Photovoltaikanlagen, Faktor Verlag 2021

Erwartete Betriebs- und Unterhaltskosten in Rp./kWh

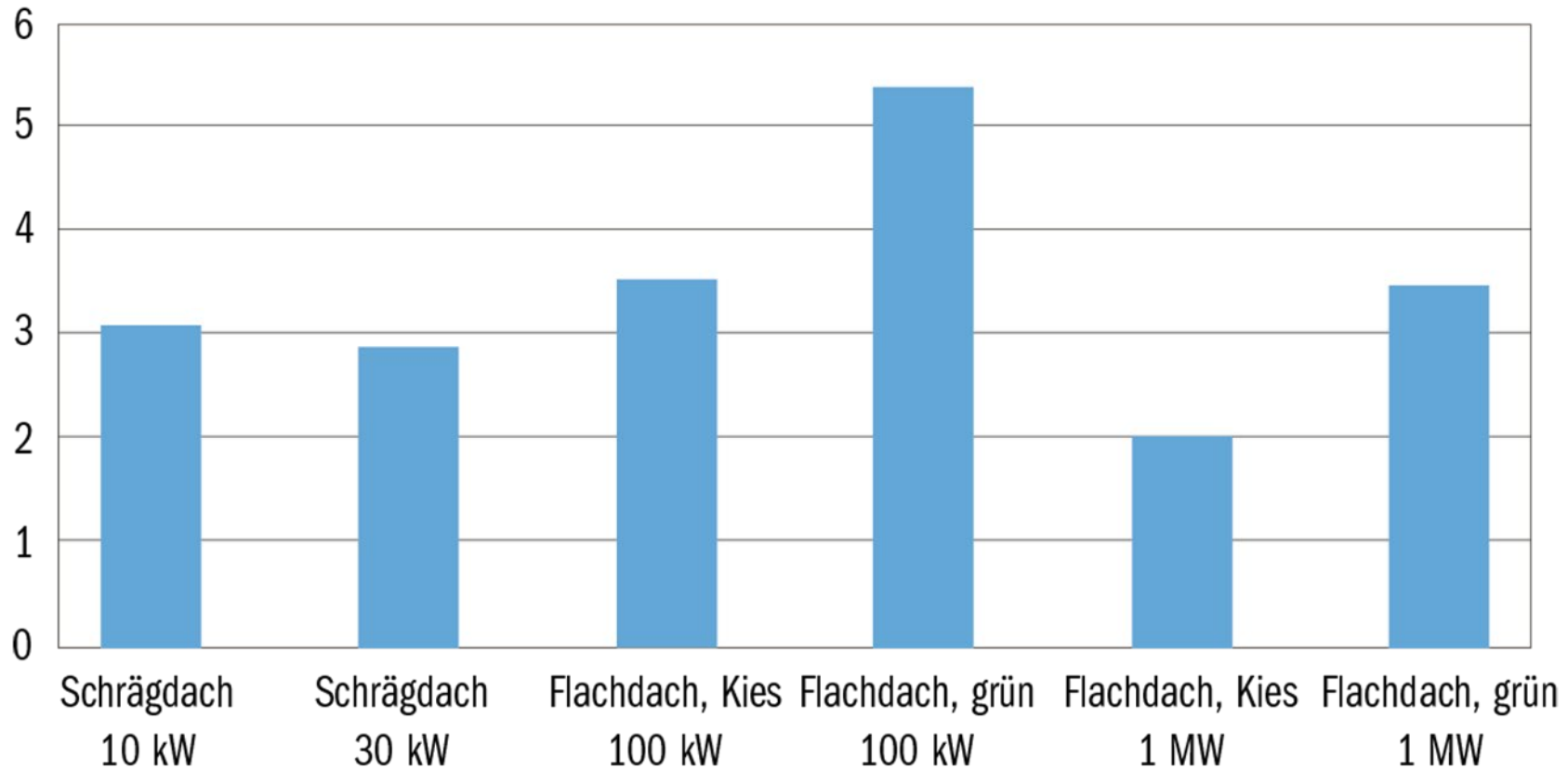

Quelle: Christof Bucher, Photovoltaikanlagen, Faktor Verlag 2021